

**EPC SYNTHESIS OF TROPANE ALKALOIDS VIA
ENANTIOSELECTIVE DEPROTONATION**

A thesis submitted to the
College of Graduate Studies and Research
in partial fulfillment of the requirements
for the degree of
Doctor of Philosophy
in the
Department of Chemistry
University of Saskatchewan
Saskatoon

by
Ryszard Lazny
February, 1996



National Library
of Canada

Acquisitions and
Bibliographic Services

395 Wellington Street
Ottawa ON K1A 0N4
Canada

Bibliothèque nationale
du Canada

Acquisitions et
services bibliographiques

395, rue Wellington
Ottawa ON K1A 0N4
Canada

Your file *Votre référence*

Our file *Notre référence*

The author has granted a non-exclusive licence allowing the National Library of Canada to reproduce, loan, distribute or sell copies of this thesis in microform, paper or electronic formats.

The author retains ownership of the copyright in this thesis. Neither the thesis nor substantial extracts from it may be printed or otherwise reproduced without the author's permission.

L'auteur a accordé une licence non exclusive permettant à la Bibliothèque nationale du Canada de reproduire, prêter, distribuer ou vendre des copies de cette thèse sous la forme de microfiche/film, de reproduction sur papier ou sur format électronique.

L'auteur conserve la propriété du droit d'auteur qui protège cette thèse. Ni la thèse ni des extraits substantiels de celle-ci ne doivent être imprimés ou autrement reproduits sans son autorisation.

0-612-23900-4

UNIVERSITY OF SASKATCHEWAN

College of Graduate Studies and Research

SUMMARY OF DISSERTATION

Submitted in partial fulfillment

of the requirements for the

DEGREE OF DOCTOR OF PHILOSOPHY

by

Ryszard Lazny

Spring, 1996

Department of Chemistry

University of Saskatchewan

Examining Committee:

Dr. F. Messier	Dean/Associate Dean/ Dean's Designate, Chair College of Graduate Studies and Research
Dr. D. B. Russell,	Chair of Advisory Committee, Department of Chemistry
Dr. R. M. Cassidy	Department of Chemistry
Dr. J. R. Dimmock,	College of Pharmacy and Nutrition
Dr. M. Majewski,	Supervisor, Department of Chemistry
Dr. P. J. Smith	Department of Chemistry
Dr. D. E. Ward,	Department of Chemistry

External Examiner:

Dr. D. Lee
Department of Chemistry
University of Regina
Regina, Saskatchewan, S4S 0A2

EPC Synthesis of Tropane Alkaloids *via* Enantioselective Deprotonation

Tropane alkaloids are a prominent group of natural products of plant origin. Many of these compounds have interesting biological activity and were challenging synthetic targets for the last century. A good synthetic strategy towards the synthesis of tropane alkaloids should be general i.e., it should provide access to several alkaloids. The desirable feature of such synthetic strategy would be the potential for obtaining the racemate and either enantiomer of the target compound *via* the same route. Enantioselective deprotonation of tropinone, which is an enantiotopic group-selective process, was used in the work described in the thesis as the key reaction for EPC synthesis of several tropane alkaloids. The work consists of two parts: methodological study of enantioselective deprotonation of tropinone with chiral lithium amide bases, and synthetic studies towards selected targets representative of several related groups of tropane alkaloids. The literature review on stereoselective synthesis of tropane alkaloids is also presented.

Deprotonation of tropinone with optically pure, chiral lithium amides was studied and effects of additives such as lithium chloride and other lithium salts (LiBr, LiI, LiClO₄) on enantioselectivity of this process were investigated. Increase of selectivity was observed upon addition of lithium chloride in all tested deprotonation reactions. Two procedures for enantioselective deprotonation of tropinone with synthetically useful selectivity were developed. When tropinone was deprotonated with a chiral lithium amide derived from (*R*)-1-[(2,2-dimethylpropyl)amino-2-phenylethyl]piperidine in a THF solution at -78 °C, in the presence of 0.5 equivalent of lithium chloride, enantioselectivity as high as 95% ee was observed. Comparable selectivity of deprotonation was

obtained using a cheaper reagent, lithium amide/lithium chloride mixture generated *in situ* by addition of 2 equivalents of n-butyllithium to the hydrochloride of (*S,S*)-(-)-*N,N*-bis(1-phenylethyl)amine. This protocol for preparation of scalemic tropinone enolate was demonstrated to provide enantioselectivity as high as 97% ee. Overly fast rate of addition of tropinone; or insufficient purity of the chiral amide, resulted in diminished enantioselectivity.

Scalemic tropinone lithium enolate, prepared *via* enantioselective deprotonation of tropinone, was used as the common chiral precursor in syntheses of nine natural products representative of seven different groups of tropane alkaloids. The natural products synthesized *via* enantioselective deprotonation of tropinone were: (overall yield from tropinone) chalcostrobamine (75%), *ent*-chalcostrobamine (73%), *ent*-darlingine (53%), *ent*-isobellendine (48%), *ent*-knightinol (46%), alkaloid KD-B (64%), *ent*-anhydroecgonine methyl ester (72%), (+)-3 α ,7- β -diacetoxytropane (37%), physoperuvine (32%), and (-)-7 β -acetoxy-3 α -tigloyloxytropane (36%). All syntheses gave products with high enantiomeric purity, ranging from 91 to 95% ee, and good to excellent overall yields. The enantioselective syntheses presented in this thesis demonstrated that nonracemic tropinone lithium enolate is an excellent reagent for EPC synthesis of different tropane alkaloids. These syntheses also established absolute configurations of pyranotropanes, chalcostrobamine, knightinol and (-)-7 β -acetoxy-3 α -tigloyloxytropane. The relative stereochemistry of knightinol was also established. It was demonstrated, that either enantiomer of the target product could be obtained with ease by using different chiral amides for the initial deprotonation of tropinone. The absolute stereochemistry of the synthetic chiral tropane derivatives could be controlled at will by the choice of the deprotonating

reagent. Both enantiomers of the chiral amines used in this work could be obtained from commercially available materials. In addition, the chiral amines could be recovered after workup (typically in more than 95%), purified, and reused.

The author has agreed that the Library, University of Saskatchewan, may make this thesis freely available for inspection. Moreover, the author has agreed that permission for extensive copying of this thesis for scholarly purposes may be granted by the professor who supervised the work recorded herein, or in his absence, by the head of the Department of Chemistry, or the Dean of the College of Graduate Studies and Research. It is understood that due recognition will be given to the author of this thesis and to the University of Saskatchewan in any use of the material of the thesis. Copying or publication or any other use of the thesis for financial gain without approval by the University of Saskatchewan and the author's permission is prohibited.

Requests for permission to copy or to make other use of material in this thesis in whole or in part should be addressed to:

The Head
Department of Chemistry
University of Saskatchewan
Saskatoon, SK, CANADA
S7N 5C9

ABSTRACT

This dissertation deals with the application of enantiotopic group selective reactions to the synthesis of enantiomerically pure compounds (EPC). Deprotonation of tropinone with optically pure, chiral lithium amides was studied. The effects of additives such as lithium chloride and other lithium salts (LiBr, LiI, LiClO₄) on enantioselectivity of deprotonation of tropinone with chiral lithium amides were investigated. Increased selectivity was observed upon addition of lithium chloride in all tested deprotonation reactions. During these studies enantioselectivity as high as 97% ee was achieved in reactions of tropinone with chiral lithium amides prepared from (*S,S*)-(-)-*N,N*-bis(1-phenylethyl)amine hydrochloride and (*R*)-1-[(2,2-dimethylpropyl)amino-2-phenylethyl]piperidine.

Two different protocols for the highly enantioselective deprotonation of tropinone were employed in EPC syntheses of tropane alkaloids: chalcostrobamine, darlingine, isobellendine, knightinol, alkaloid KD-B, physoperuvine, 7 β -acetoxy-3 α -tigloyloxytropane, and 3 α ,7 β -diacetoxytropane. The products were obtained in good overall yields and in high optical purity (91-97%).

The presented work shows that the enantioselective deprotonation of cyclic C_s symmetrical ketones is an attractive approach to the synthesis of enantiomerically pure natural products.

TABLE OF CONTENTS

Abstract	ii
Table of Contents	iii
Acknowledgments	vii
List of Tables	viii
List of Figures	x
List of Abbreviations	xi
CHAPTER I : INTRODUCTION	1
1. Desymmetrization of C_S symmetric ketones <i>via</i> enantioselective deprotonation as a strategy for EPC synthesis	2
1.1. General concepts	
1.2. Enantioselective deprotonation	7
1.3. Chiral lithium amide bases	12
1.4. Effects of additives on the selectivity of deprotonation	13
1.5. Reactions of ketone lithium enolate with electrophilic reagents	14
2. Stereoselective synthesis of tropane alkaloids: Literature review	18
2.1. Synthesis of achiral alkaloids	20
2.2. Synthesis of chiral alkaloids in racemic form	29
2.3. EPC synthesis of tropane alkaloids	46
2.3.1. EPC synthesis based on resolution	47
2.3.2. Synthesis from enantiomerically pure starting material	53
2.3.3. Enantioselective synthesis	63

CHAPTER II : RESULTS AND DISCUSSION	70
1. Introduction	
Tropinone enolate as a reagent for tropane synthon: Formidable entry into EPC synthesis of tropane alkaloids	70
2. Methodological studies	73
2.1. Enantioselective deprotonation of tropinone with chiral lithium amides	75
2. 2. Effects of lithium salts on deprotonation of tropinone	89
2. 3. <i>In situ</i> generation of lithium amide/lithium chloride mixture and other effects	100
2.4. Conclusions	101
3. Synthetic studies	103
3.1. Alkoxyacylation of tropinone enolate: Synthesis of anhydroecgonine methyl ester	107
3.2. Acylation of tropinone enolate: Synthesis of chalcostrobamine and pyranotropanes	111
3.3. Hydroxybenzylation of tropinone enolate: Synthesis of knightinol	117
3.4. Alkylation of tropinone enolate: Synthesis of alkaloid K-DB	119
3.5. Introduction of OH at C-6 or C-7 of the tropane system: Synthesis of 7 β -acetoxy-3 α -tigloyloxytropane and 3 α ,7 β -diacetoxytropane	120
3.6. 1,3-Carbonyl transposition: Synthesis of physoperuvine	126

3.7. Reaction of cyanide with methoxycarbonyltropanone derivatives	130
3.8. Other reactions of lithium enolates with electrophiles	133
3.9. Conclusions	136
CHAPTER III : SUMMARY AND FUTURE WORK	137
1. Summary	137
2. Future Work	139
CHAPTER IV : EXPERIMENTAL	141
1. General methods and analytical methods	141
2. Methodological studies	143
2.1. Synthesis of chiral amines derived from α -methylbenzylamine	143
2.2. Synthesis of chiral amines derived from phenylglycine	151
2.3. Procedure for measurement of enantioselectivity of deprotonation of tropinone <i>via</i> acylation reaction	160
2.4. Procedure for measurement of enantioselectivity of deprotonation of tropinone <i>via</i> aldol reaction	161
2.5. Procedure for recovering and purification of chiral solvating agent (S)-(+)-TFAE	162
3. Syntheses	163
3.1. Generation of lithium tropinone enolate	163
3.2. Synthesis of <i>ent</i> -anhydroecgonine methyl ester	165

3.3. Synthesis of both enantiomers of chalcostrobamine, <i>ent</i> -darlingine and <i>ent</i> -isobellendine	168
3.4. Synthesis of <i>ent</i> -knightinol	181
3.5. Synthesis of alkaloid KD-B	188
3.6. Synthesis of (-)-7 β -acetoxy-3 α -tigloyloxytropane and (+)-3 α ,7 β -diacetoxytropane	193
3.7. Synthesis of physoperuvine	211
3.8. Synthesis of derivatives of nortropinone and other reactions	223
REFERENCES	235

ACKNOWLEDGMENTS

I wish to thank my supervisor Prof. Marek Majewski for his help, time, and most of all for his patience. I would like to extend my thanks to my colleagues for their support; Guo-Zhu Zheng, Mark Gleave, John MacKinnon, Scott Zook, Pawel Nowak, Dr. Nick Irvine, Jianxing Shao and especially to Agnieszka Ulaczyk for her help in typing and correcting the thesis.

I express my gratitude to the members of my advisory committee; Dr. R. Cassidy, Dr. J. Dimmock, Dr. D. Russell, Dr. P. J. Smith, and especially to Dr. D. E. Ward, for their guidance and encouragement. I would also wish to thank my external examiner Dr. Don Lee. Thanks to all those members of the chemistry department who made my stay in Saskatoon enjoyable one. Special mention is given to Prof. A. Baranski for helpful discussions and his assistance with cyclic voltammetry analysis, to Chuk Mann for his help with correcting the thesis, to Dr. K. Brown and Ken Thoms for their help with instrumental analysis. I am also grateful to Professors M. Lounasmaa (Finland) and R. Bick (Australia) for providing samples of natural alkaloids. The financial support of the University of Saskatchewan (University Scholarship) and NSERC Canada is gratefully acknowledged.

LIST OF TABLES

Table 1.1.	Stereoselective reduction of tropinone (66).	25
Table 1.2.	Examples of Furuya and Okamoto transformations.	38
Table 1.3.	Examples of resolution of 6 β -functionalized tropanes.	51
Table 2.1.	Enantioselectivity of deprotonation of tropinone observed previously in our laboratory by G.-Z. Zheng.	76
Table 2.2.	Relative enantioselectivity of deprotonation of tropinone by chiral lithium amides derived from phenylglycine.	84
Table 2.3.	Enantioselectivity of deprotonation of tropinone probed by the acylation reaction.	85
Table 2.4.	Enantioselectivity of deprotonation of tropinone probed by the aldol reaction.	86
Table 2.5.	Results of measurements of ee by integration of NMR signals for highly enantiomerically enriched sample.	88
Table 2.6.	Effects of addition of LiCl on enantiopurity of benzyl carbamate 465 .	91
Table 2.7.	The effect of addition of LiCl on acylation of tropinone.	93
Table 2.8.	Influence of lithium chloride on enantiomeric excess of aldol 440 prepared by deprotonation with chiral amides.	94
Table 2.9.	Influence of lithium salt additives on enantiomeric excess of aldol 440 prepared with amide 441a .	99
Table 2.10.	Influence of addition of 1 equivalent of lithium salt on enantiomeric excess of aldol 440 prepared with amide 442a .	99
Table 2.11.	The effect of the rate of addition of tropinone to chiral lithium amide on enantioselectivity of deprotonation.	101
Table 2.12.	Absolute stereochemistry of tropane alkaloids.	106

Table 2.13. Absolute stereochemistry of deprotonation of tropinone with chiral lithium amides.	110
Table 3.1. Natural products synthesized <i>via</i> enantioselective deprotonation of tropinone.	139

LIST OF FIGURES

Figure 1.1.	Enantioselective reactions from the early works of Koga and Simpkins.	8
Figure 1.2.	Structures of selected complexes of lithium amides in THF.	10
Figure 1.3.	Representative examples of chiral amines derived from readily available materials.	12
Figure 1.4.	Structures of monomer and dimer of chiral lithium amide derived from phenylglycine.	13
Figure 1.5.	Tropane and nortropane numbering used in this thesis.	18
Figure 1.6.	Representative examples of tropane alkaloids.	19
Figure 2.1.	Representative examples for each of the different groups of tropane alkaloids.	70
Figure 2.2.	Tropinone, tropinone lithium enolate and π - σ^* orbital interactions favoring abstraction of the axial hydrogen.	74
Figure 2.3.	Structures of chiral lanthanide shift reagent and chiral solvating agent used for ee analysis of aldol 440 .	82
Figure 2.4.	Effect of added LiCl on optical purity of 465 .	91
Figure 2.5.	Effect of added LiCl on enantiopurity of 467 .	93
Figure 2.6.	Effect of added LiCl on enantiopurity of 440 .	95
Figure 2.7.	Effect of added LiCl on enantioselectivity of deprotonation with 450a .	96
Figure 2.8.	Absolute configuration of natural tropane alkaloids correlated through syntheses <i>via</i> enantioselective deprotonation.	136
Figure 3.1.	Effect of optimization of reaction conditions on enantioselectivity of deprotonation of tropinone.	138

LIST OF ABBREVIATIONS

$[\alpha]_D^t$	specific rotation at temperature t °C
Ac	acetyl
aq	aqueous
Anal.	elemental analysis
Boc	<i>tert</i> -butoxycarbonyl
<i>n</i> -BuLi	<i>n</i> -butyllithium
bp	boiling point
Cbz	benzyloxycarbonyl
CI	chemical ionization
<i>m</i> -CPBA	<i>meta</i> -chloroperbenzoic acid
DFC	dry flash column chromatography
DCC	dicyclohexylcarbodiimide
DIAD	diisopropyl azodicarboxylate
DMAP	4-dimethylaminopyridine
DMF	dimethyl formamide
ee	enantiomeric excess
EI	electron impact ionization
EPC	enantiomerically pure compound
FCC	flash column chromatography
GC	gas chromatography
h	hour
HMPA	hexamethylphosphoramide
HPLC	high pressure liquid chromatography
Hz	hertz
Im	imidazole

IR	infrared
LAH	lithium aluminum hydride
LDA	lithium diisopropylamide
min	minutes
mp	melting point
Ms	mesyl
MS	mass spectrometry
NMR	nuclear magnetic resonance
ot	oven temperature (Kugelrohr distillation)
P	protecting group
Pd/C	palladium on charcoal
PDC	pyridinium dichromate
Ph	phenyl
PPTS	pyridinium <i>para</i> -toluenesulfonate
psi	pounds per square inch
<i>p</i> -TsOH	<i>para</i> -toluenesulphonic acid
Py	pyridine
ref	reference
R _f	retention factor (in chromatography)
rt	room temperature
sat	saturated
SCC	short column chromatography
TBAF	tetrabutylammonium fluoride
TBDMS	<i>tert</i> -butyldimethylsilyl
(+)-TFAE	(<i>S</i>)-(+)-2,2,2-trifluoro-1-(9-anthryl)ethanol
Tf	triflyl
Tg	tigloyl

THF	tetrahydrofuran
TLC	thin layer chromatography
TMS	trimethylsilyl
Ts	tosyl
Troc	2,2,2-trichloroethyloxycarbonyl
UV	ultraviolet

CHAPTER I : INTRODUCTION

Progress in the synthesis of organic compounds (whether industrial or laboratory) is driven by an aspiration to attain a higher degree of perfection.¹ A good synthesis should be concise, simple, and selective. An efficient preparation of the desired substance *via* a multistep synthesis depends on the strategy and on the selectivity of reactions constituting particular steps of the synthetic plan. The issues of regio-, chemo- and, stereoselectivity have to be satisfactorily addressed in any modern synthesis.² The elaboration of syntheses of new target molecules and progress in synthetic methodology are intimately linked. An endeavor to synthesize a new product of challenging complexity incites discoveries of new reagents, reactions, and new reaction conditions as well as novel strategies. On the other hand, progress in synthetic methodology improves the quality and the quantity of tools available to synthetic organic chemists. This in turn allows known syntheses to be improved and new targets to be tackled. The best way for a convincing demonstration of the power of a novel synthetic strategy or methodology is its successful implementation in the synthesis of a selected target.

The work presented in this thesis consists of two parts: methodological studies on enantioselective formation of tropinone lithium enolate, and synthetic studies towards chiral tropane alkaloids. The EPC syntheses³ (syntheses of enantiomerically pure compounds) of tropane alkaloids are designed around the enantioselective deprotonation reaction as the key transformation. The author's work is an attempt to illustrate the idea that

desymmetrization of C_s symmetric ketones, through enantioselective deprotonation, provides a general and powerful strategy for enantioselective synthesis of natural products. The conceptual basis of desymmetrization of ketones *via* enantioselective deprotonation with chiral lithium amide bases and a literature review on synthesis of tropane alkaloids will be presented in the two following sections.

1. Desymmetrization of C_s symmetric ketones *via* enantioselective deprotonation as a strategy for EPC synthesis

1.1. General Concept

EPC synthesis was defined by Seebach *et al.* as any type of synthesis leading to enantiomerically pure compounds. The term "enantiomerically pure compound" is arbitrary, and depends on practical requirements and available analytical methods.³ For example, a substance of an enantiomeric excess (ee) of above 90% could be regarded as enantiomerically pure for some synthetic applications, but a purity higher than 99.9% ee may be needed for biological testing.

There are only three conceptually different types of EPC synthesis i.e., syntheses based on:

- a) resolution of a racemate (Scheme 1),
- b) use of a starting material from the pool of available chiral building blocks (Scheme 2),
- c) enantioselective conversion of an achiral material to the enantiomerically pure compound (Scheme 3).

The resolution of a racemate can be accomplished by an enantiomer-selective process i.e.: a chemical reaction (kinetic resolution) or by a physical

method (e.g., chromatography on a chiral stationary phase), or by a conversion to a mixture of diastereomers followed by diastereomer-selective process (e.g., chromatography or crystallization). Resolution of a racemate *via* the formation and the separation of the diastereomers requires two additional steps as compared to the enantiomer-selective process (Scheme 1). In addition, the maximum yield of the EPC synthesis based on resolution of a racemate is limited to 50%, unless the undesired enantiomer can be racemized *in situ*. Because of this disadvantage, the resolution based approach is usually the least economical of the three types of EPC synthesis.

Scheme 1

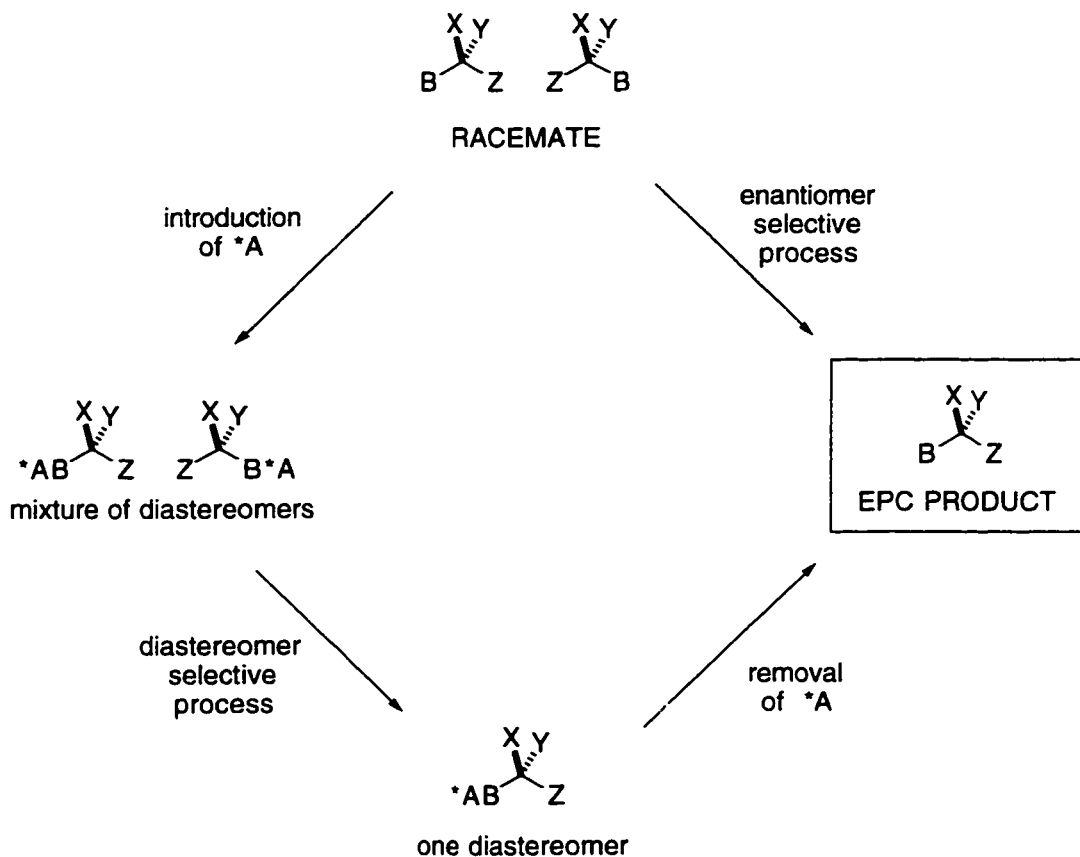

Note: *A represents a chiral moiety

The second type of EPC synthesis takes advantage of the pool of available enantiomerically pure compounds. The elements of chirality of the available chiral building blocks can be built into molecules of products with or without the formation of additional elements of chirality (Scheme 2). When the new stereogenic element is formed in a chiral molecule, two diastereomers can result. In a diastereoselective process the diastereomers are formed in unequal amounts. The diastereoselective synthesis can be based on a selective manipulation of diastereotopic groups (diastereotopic group-selective

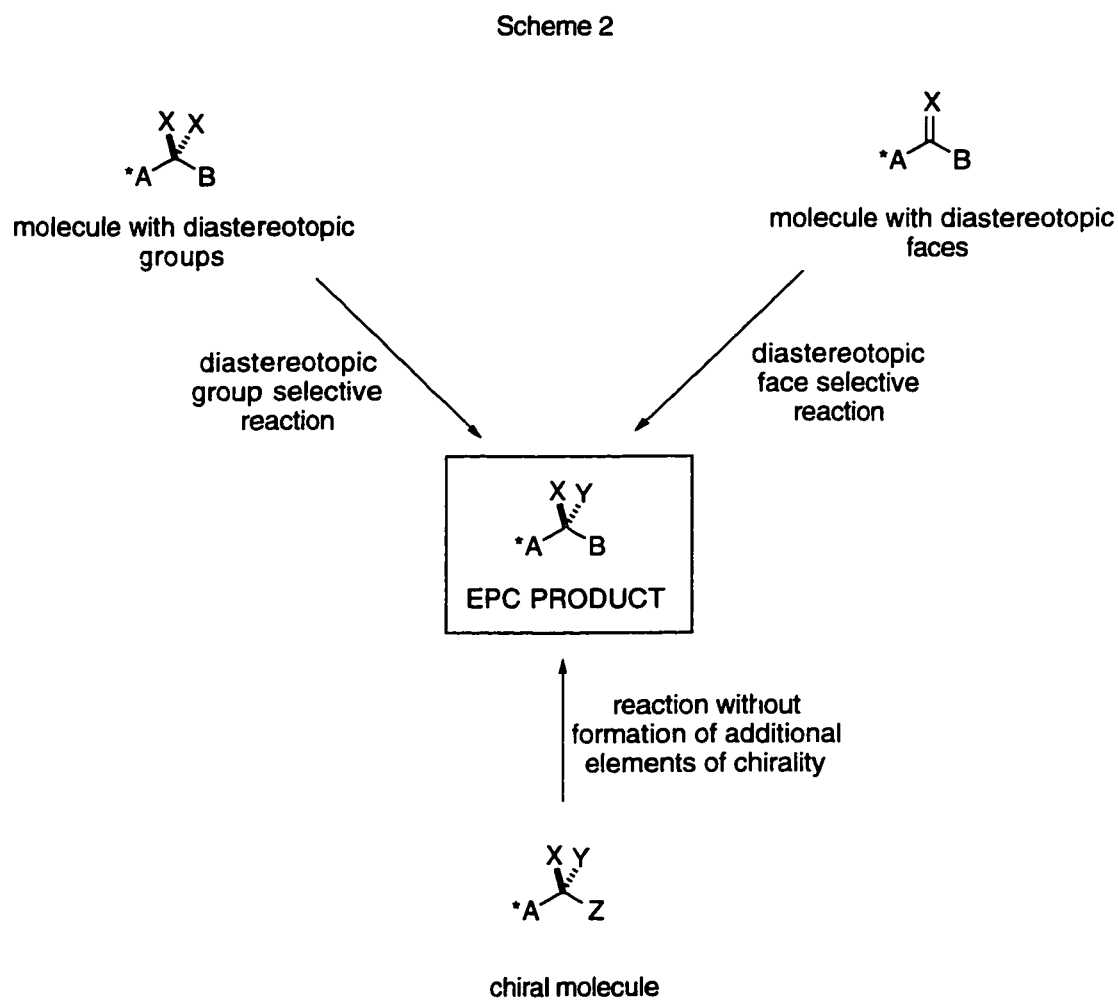

Note: *A represents a chiral moiety

reaction) or on selective addition to diastereotopic faces (diastereotopic face-selective reaction). Such syntheses were the first chemical methods for "asymmetric synthesis" and, although fairly successful in many cases, they were limited by the availability of chiral building blocks. The access to both enantiomers of the product from the same starting material is usually troublesome. The principle of diastereodifferentiation constitutes a basis of chiral auxiliary strategy. The chiral auxiliary is a chiral entity which is temporarily attached to an achiral substrate in order to provide a chiral environment and which is ultimately removed, following diastereoselective steps of the synthesis. Introduction of chiral auxiliaries to an achiral substrate molecule changes the problem of differentiation between enantiotopic groups or faces to differentiation between diastereotopic groups or faces (Scheme 2). The obvious disadvantage of such approach to EPC synthesis are the two additional steps of introduction and removal of the chiral auxiliary.

The third type of EPC synthesis uses enantioselective transformation of achiral starting material to chiral product (Scheme 3). Such enantioselective synthesis requires the influence of a chiral factor (e.g., solvent, reagent, catalyst or circularly polarized light). Chiral reagents and catalysts, unlike the chiral auxiliaries, can cause differentiation between the two enantiotopic groups or faces without being connected to the starting material by covalent bonds. This is a very desirable feature, since there is no need to introduce and remove the chiral element in separate reactions before and after the stereoselective step of the synthesis. On the other hand, it is usually more difficult to obtain a high degree of stereoselectivity when the chiral elements are bound to the substrate by weaker non covalent bonds. As a result, until recently, there was very few examples of practical applications of enantioselective reactions.^{4a} The selective manipulation of one of the

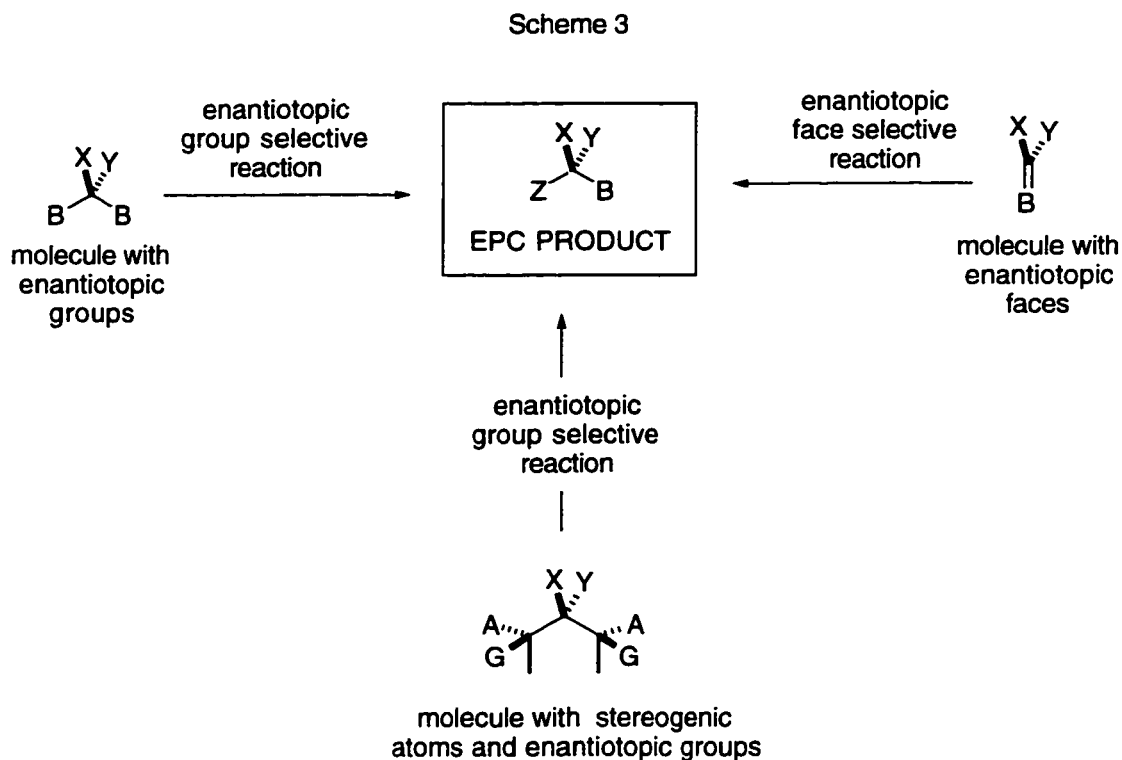

enantiotopic groups of the starting material molecule deprives the molecule of its symmetry. Such desymmetrization of molecules possessing a plane of symmetry (C_s symmetry group) can be used as the pivotal transformation in a strategy for the synthesis of chiral nonracemic product from achiral starting materials.

A good EPC synthesis should have the following characteristics:³

- a) it should be simple and concise (as few steps as possible),
- b) it must give the desired product in high ee and in high chemical yield,
- c) the chiral reagents or auxiliaries should be easily separable from the product and recoverable in good yields and in unchanged optical purity.

In light of these requirements it is clear that the chiral reagent approach is superior to the chiral auxiliary strategy provided that the satisfactory stereoselectivity and generality can be obtained.

1.2. Enantioselective Deprotonation

Desymmetrization of C_s symmetric compounds which have stereogenic centers can be used as the key to a strategy for EPC synthesis (Scheme 3). A way in which this notion can be put to practice is deprotonation of cyclic C_s symmetric ketones by a chiral optically pure base (Scheme 4).

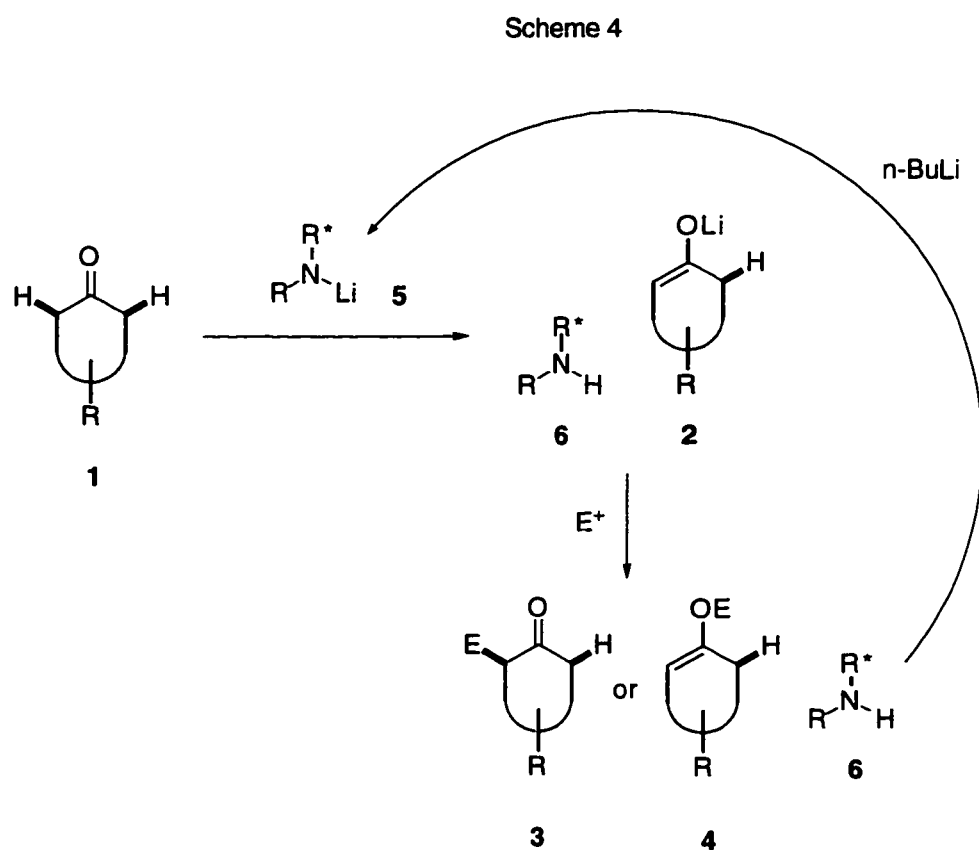

If the deprotonation reaction is to be kinetically controlled the base needs to be strong enough to make the process of deprotonation practically irreversible. Lithium amides (e.g., LDA) are known to effectively deprotonate

ketones even at low temperatures to give lithium enolates.^{4b} Deprotonation of a C_s symmetric ketone with an achiral base, such as LDA, will result in the racemic enolate product. If the lithium amide base is chiral (i.e., derived from a chiral amine) the nonracemic (scalemic) lithium enolate should be formed (Scheme 4). A reaction of the scalemic lithium enolate with various electrophiles (E^+) could provide access to a number of enantiomerically pure products. The chiral amine **6**, used to produce the lithium amide, should be recovered without deterioration of optical purity and should be reused (Scheme 4). Thus the whole process, if sufficiently enantioselective, could constitute a good EPC synthesis.

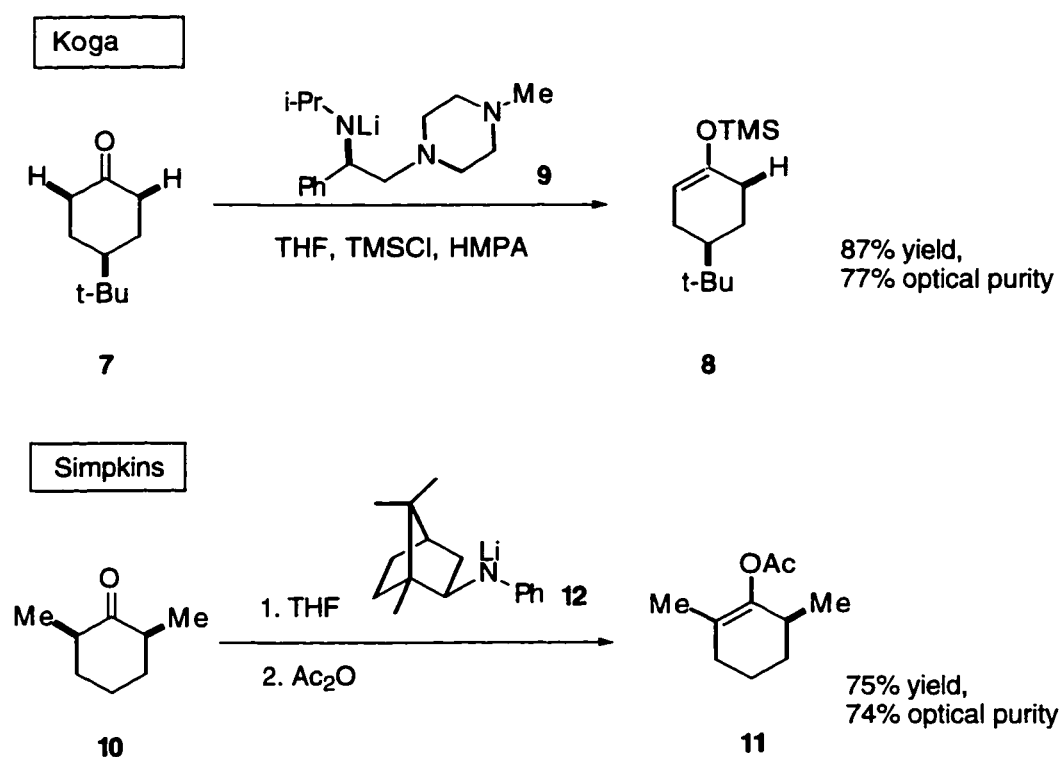
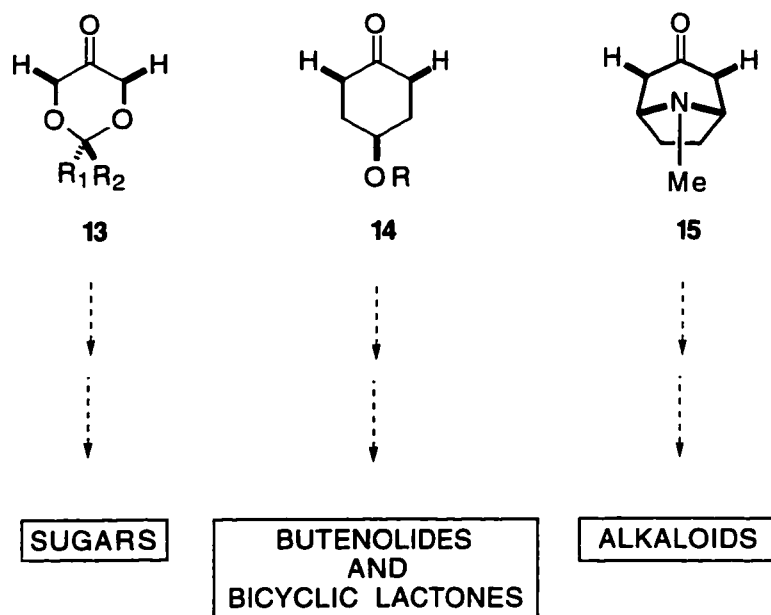

Fig. 1.1. Enantioselective reactions from the early works of Koga⁷ and Simpkins⁶

The enantioselective proton transfer processes, among them enantioselective deprotonation reactions, have recently been reviewed.⁵ The enantioselectivities of the first examples of enantioselective deprotonation of cyclic ketones (at $-78\text{ }^{\circ}\text{C}$) reported in 1986 independently by Koga and Simpkins ranged from very low to modest (5-77% ee, Figure 1.1).^{6,7} The enantioselective deprotonation of cyclic ketones and its synthetic applications were one of the main research interests of our group since 1985. Recently we focused our attention mainly on cyclic ketones of high synthetic utility, such as tropinone (**15**), 4-hydroxycyclohexanone derivatives (**14**), and 1,3-dioxan-5-one derivatives (**13**). Lithium enolates of these ketones could provide attractive entries into synthesis of natural products (Scheme 5).

Scheme 5



In 1991, when I started this project, the concept of deprotonation of cyclic ketones by chiral lithium amide bases was, in principle, fairly well established.⁸ However, only a few examples of deprotonation reactions with

synthetically useful enantioselectivity were reported.^{9,10} One of the most interesting ketones, from a synthetic application point of view, is tropinone (15). The pioneering work on deprotonation of tropinone and the synthesis of tropane alkaloids from nonracemic tropinone lithium enolate was done in our laboratory by Guo-Zhu Zheng.¹¹⁻¹³ He was the first to observe several interesting reactions of tropinone enolate with electrophiles (e.g., benzaldehyde and ethyl chloroformate). He also accomplished the first enantioselective synthesis of a natural product from tropinone (anhydroecgonine methyl ester in 21% optical purity). Nevertheless, the answers still had to be found to the following questions: (i) Is it possible to deprotonate tropinone with synthetically useful enantioselectivity? (ii) What are the optimal conditions for enantioselective deprotonation of tropinone? (iii) Can we develop EPC syntheses of natural products based on the deprotonation of tropinone?

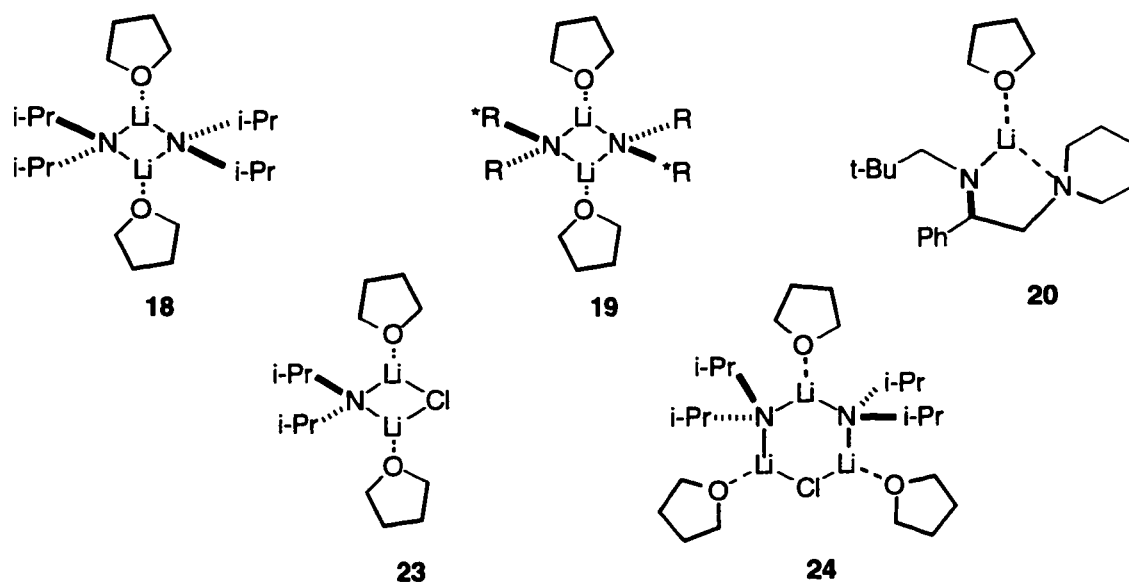
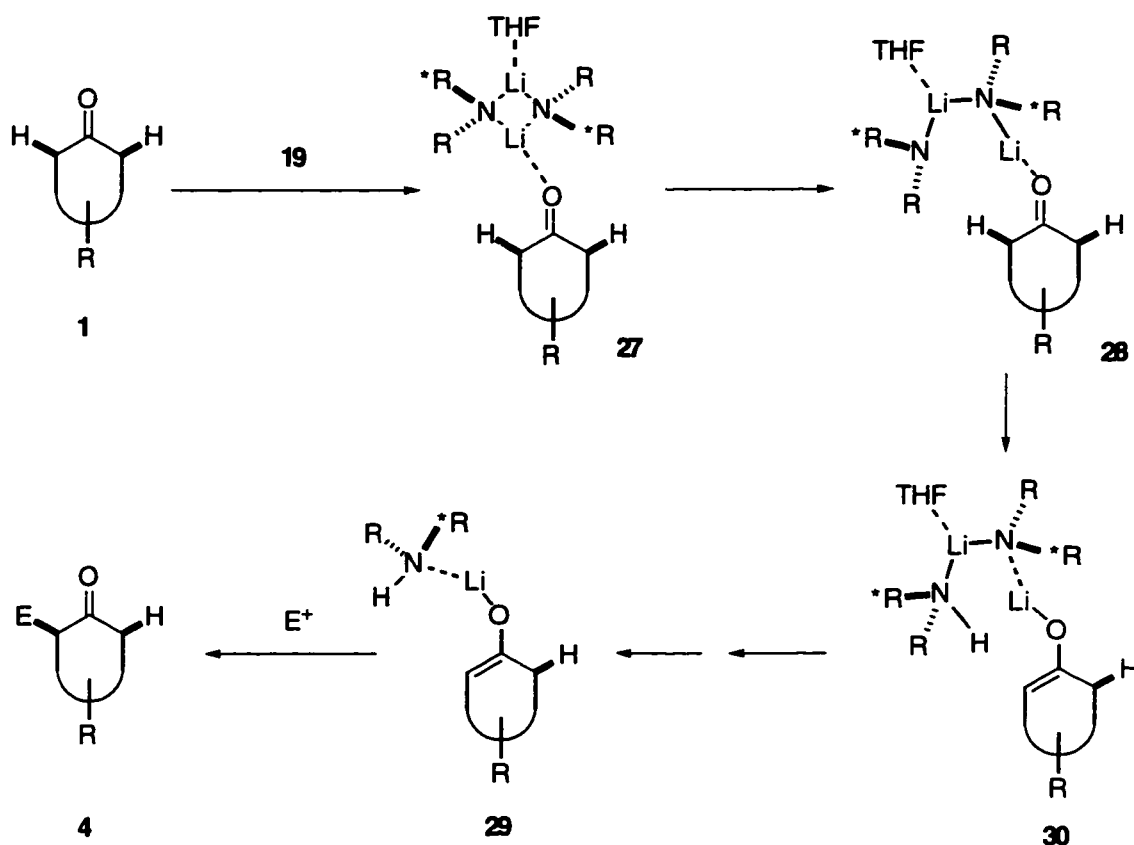

Fig. 1.2. Structures of selected complexes of lithium amides in THF

Scheme 6



Although the process of deprotonation of a cyclic ketone by lithium amide bases is not totally understood, the following simplified description can be offered. By analogy with the structure of LDA which was shown by Collum¹⁴ to form the solvated dimer **18** (Figure 1.2), one could expect that the chiral lithium amides should exist in THF solution in forms of dimers **19**. There was also substantial experimental evidence that, prior to the deprotonation, complexation of the chiral lithium amide to the carbonyl group of the ketone occurs (Scheme 6).¹⁵⁻¹⁷ In the next step, the dimer of the amide had to open up to free the electron pair on one of the nitrogen atoms and form **28**. The chirality of the lithium amide ensures that the transition states leading to the

enantiomeric products of deprotonation are diastereomeric, and thus have different energies. After the actual deprotonation, the enolate remains complexed to the amine.^{22,29a,29c} The enolate-amine complex **29** reacts with the subsequently added electrophile to form the stable, enantiomerically enriched product **4**. The most important factors affecting enantiomeric purity of the product seem to be the steric interactions between the cyclic ketone and the lithium amide, which in turn depends on the structure of the latter.

1.3. Chiral lithium amide bases

Chiral lithium amides are typically prepared *in situ* by deprotonation of chiral secondary amines with *n*-butyl lithium.¹³ Since the structure of the chiral lithium amide plays a major role in influencing the enantioselectivity of the proton transfer process, much effort was concentrated on development of chiral secondary amines. These chiral amines were usually prepared from optically pure readily available materials. One can distinguish three major groups: amines derived from terpenes (e.g. **12**), from aminoacids (e.g. **31**), and from α -methylbenzylamine (e.g. **R-32**).

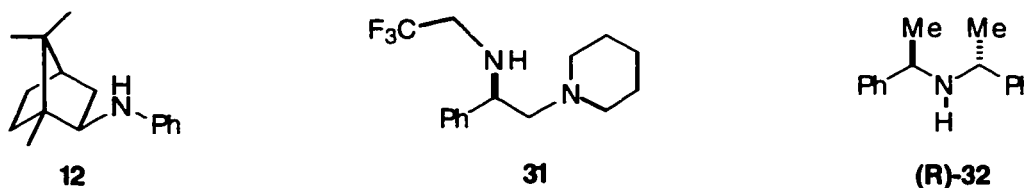

Fig.1.3. Representative examples of chiral amines derived from readily available materials

The most promising amines were thought to be bidentate compounds (e.g., **31**) derived from phenylglycine. Binding of the lithium ion to the two coordination sites was hoped to provide a more conformationally restricted

structure of the reagent and thus the stronger stereochemical differentiation in the transition state. Recently, Koga has showed that the bidentate lithium amide **20** exists as the monomer (**25**) in THF, and as a dimer (**26**) in an ether-toluene mixture (Figure 1.4).¹⁸ It is reasonable to expect that different oligomers of an amide will show different reactivity and selectivity in the deprotonation reaction. Experimental data indicate that the amide **20** shows lower selectivity of deprotonation of 4-t-butylcyclohexanone in ether than in THF, 64 vs. 84% ee respectively.^{18a} It seems that enantioselectivity of deprotonation may depend on the degree of aggregation of lithium amide, which in turn depends on the solvent.

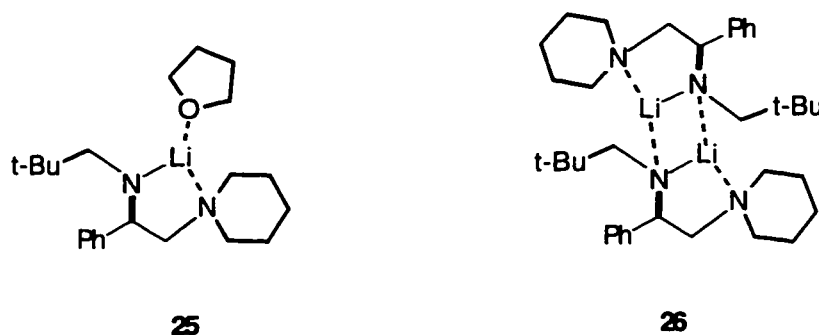
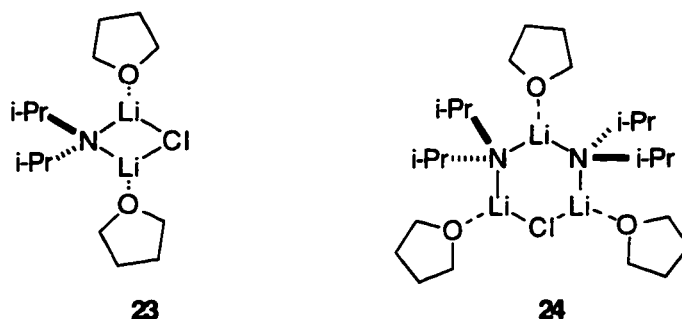

Fig. 1.4. Structures of monomer and dimer of chiral lithium amide derived from phenylglycine

1.4. Effects of additives on the selectivity of deprotonation

The degree of aggregation of lithium amides may be affected not only by the solvent but also by other substances present in the reaction mixture. Examples of improved and even reversed enantioselectivity upon addition of HMPA were reported by Koga.⁷ In our laboratory, Mark Gleave observed different enantio- and diastereoselectivity of the aldol reaction in the presence and absence of LiBr.²⁷ In 1991, Collum reported the NMR evidence for mixed LDA lithium chloride aggregates (**23** and **24**) and showed that the diastereoselectivity of enolization of pentanone (E vs. Z enolate formation) was

dependent on the amount of added LiCl.²⁰ By analogy, the structures of chiral lithium amide oligomers and aggregates should be dependent on the type and the amount of additives. Recently, Simpkins published the results of a study on the influence of LiCl and of other additives (e.g., ZnCl₂) on the enantioselectivity of deprotonation of ketones.^{21,24,25} An improvement of selectivity from 15 to 68% ee was reported with the optimum enantioselectivity obtained upon the addition of 0.8 equivalents of added ZnCl₂.²¹



The above results show that the enantioselectivity of deprotonation of cyclic ketones with chiral lithium amide can be improved by addition of compounds like inorganic salts or HMPA. Optimization, however, of the amount of the additive is required for each case.

1.5. Reactions of ketone lithium enolates with electrophilic reagents

After a proton is transferred to the amide nitrogen atom, the deprotonation is, in principle, completed. There is, however, some experimental evidence suggesting that the products of deprotonation, namely the chiral lithium enolate and chiral amine, remain complexed together.²² Such complexation of the nonracemic enolate and the chiral amine should result in the formation of the diastereomeric complexes in unequal amounts (Scheme 7). The rates of reaction of such diastereomeric species with an

achiral electrophile should be different. Thus, the ratio of the enantiomeric products, resulting from a reaction between the enolate and the electrophile, may differ from the ratio of enantiomeric enolates if the reaction of the enolate with the electrophile does not reach 100% conversion, or if the deprotonation step is reversible.

Scheme 7

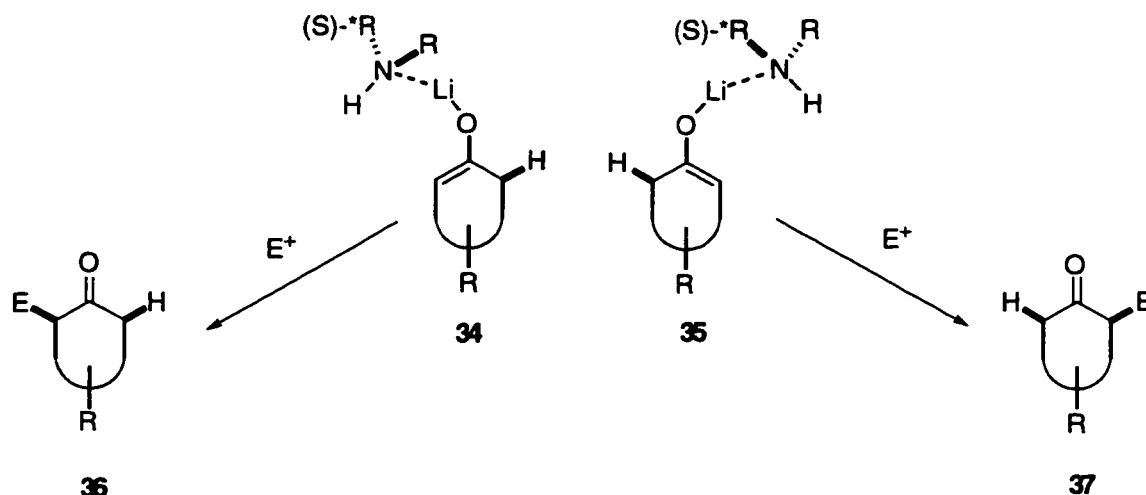

Tropinone lithium enolate has three potentially reactive nucleophilic termini. The reaction with an electrophile may take place on the oxygen, carbon, or nitrogen atoms (Scheme 8).^{12,13} Thus the control of regioselectivity will be necessary for a successful synthetic implementation of these reactions. The control of ambidoselectivity (regioselectivity of reaction of ambident reagents) can be achieved by the use of appropriate reagents. For example, Mander has demonstrated that acyl cyanides react virtually exclusively on the carbon terminus of an enolate.¹⁹ On the other hand, silylation of enolates with trimethylsilyl chloride takes place on the oxygen.¹³

Scheme 8

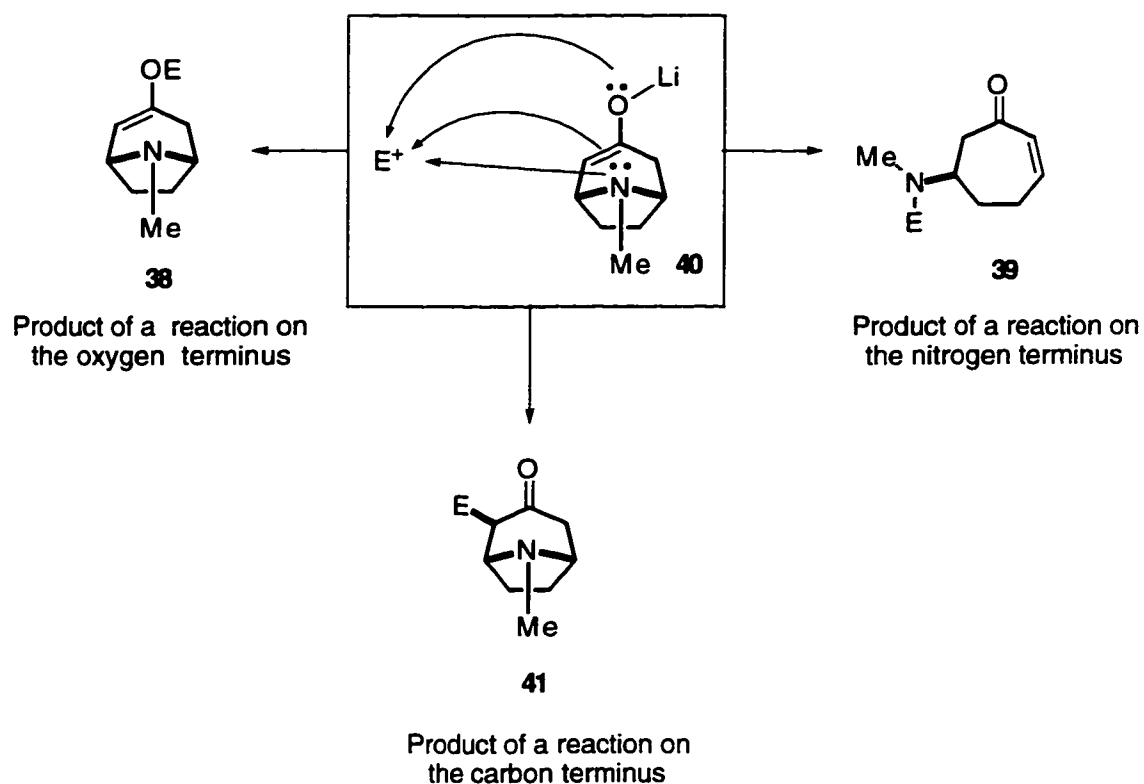

Appropriate transformations of tropinone and *N*-substituted nortropinone derivatives could expect to open up the route to several groups of natural products as shown retrosynthetically in Scheme 9. The biggest advantage of such approach could be its generality and accessibility of the racemate and both enantiomers of the target compound by the same method. Since the optical purity of the target compound is established, principally, by the enantioselective transformation, i.e., the enantioselective formation of the ketone lithium enolate, the viability of this whole strategy for EPC synthesis depends on control of enantioselectivity of that key step.

Scheme 9

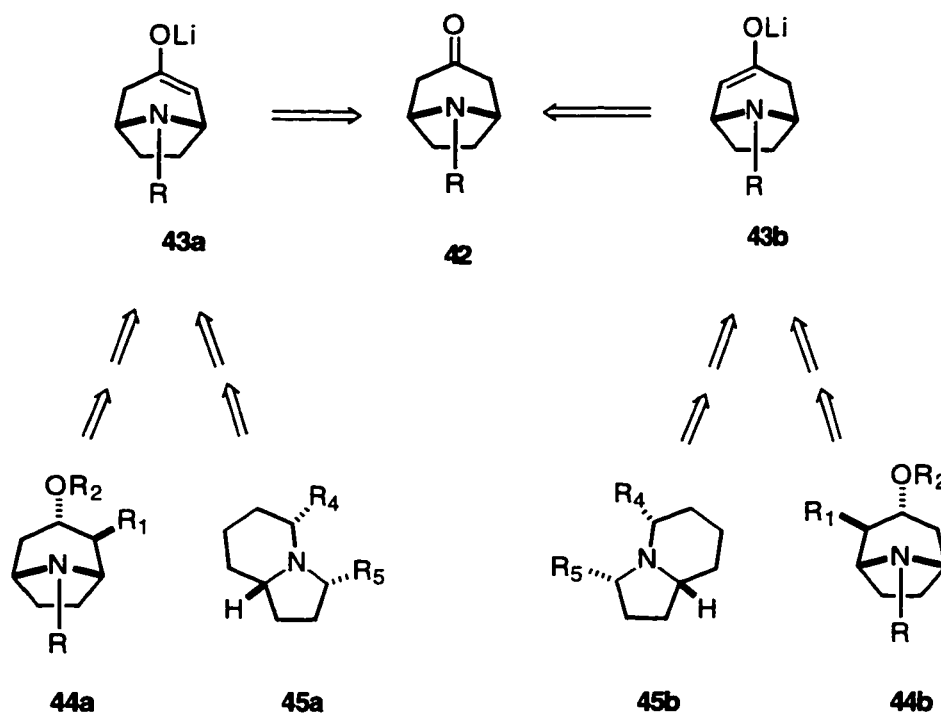

In order to make deprotonation of tropinone a useful entry to the EPC synthesis of chiral tropane alkaloids and other natural products, it is necessary to find suitable conditions for achieving satisfactory enantioselectivity. That would require testing of various deprotonating agents, reaction conditions, and additives e.g., lithium salts or HMPA. Appropriate transformations of tropinone lithium enolate to reach the selected targets will have to be elaborated.

2. Stereoselective Synthesis of Tropane Alkaloids: Literature review

The alkaloids are a large class of natural products of plant origin. A characteristic feature of compounds of this class is their weak basicity and the presence of nitrogen. The tropane alkaloids are a well-recognized group comprising over 200 structurally related compounds.³³ They occur mainly in plants of the *Solanaceae* family but can also be found in other families *Erythroxylaceae*, *Proteaceae*, *Convolvulaceae*, and *Rhizophoraceae* and occasionally in other plants. All tropane alkaloids contain a common structural element: 8-azabicyclo[3.2.1]octane (nortropine) or its 8-methyl analog tropane (Figure 1.5). The uniform numbering system (Figure 1.5) accepted for tropane alkaloids³³ will be used for tropinone derivatives in this thesis. Many of the tropane derivatives possess interesting biological activity (e.g.: mydriatic, anesthetic, anticholinergic, and ganglion blocking activity).^{34,35}

Since the early days of organic chemistry, alkaloids were challenging targets for synthesis. This section provides an overview of the strategies and methods used in the synthesis of tropane derivatives, up to 1995, with emphasis being placed on aspects of stereoselectivity. Syntheses of isotopically labeled alkaloids and reactions of tropane derivatives limited solely to trivial manipulations of functional groups present on tropane skeleton are not covered.

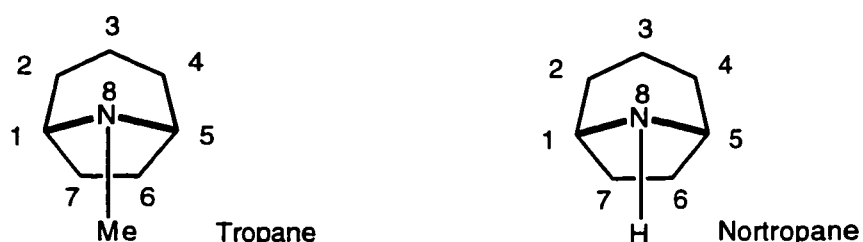

Fig. 1.5. Tropane and nortropine numbering used in this thesis

Strategies used in syntheses of tropane derivatives can be divided into two main groups: (i) Strategies based on the synthesis of the tropane skeleton containing masked functionalities or groups which can be transformed into the required substituents. (ii) Strategies based on the functionalization or manipulation of available tropane derivatives. The second group of strategies relies on tropinone or functionalized tropane derivatives as starting materials. Thus, syntheses of tropinone, nortropinone and their symmetrical (achiral) derivatives will be discussed first.

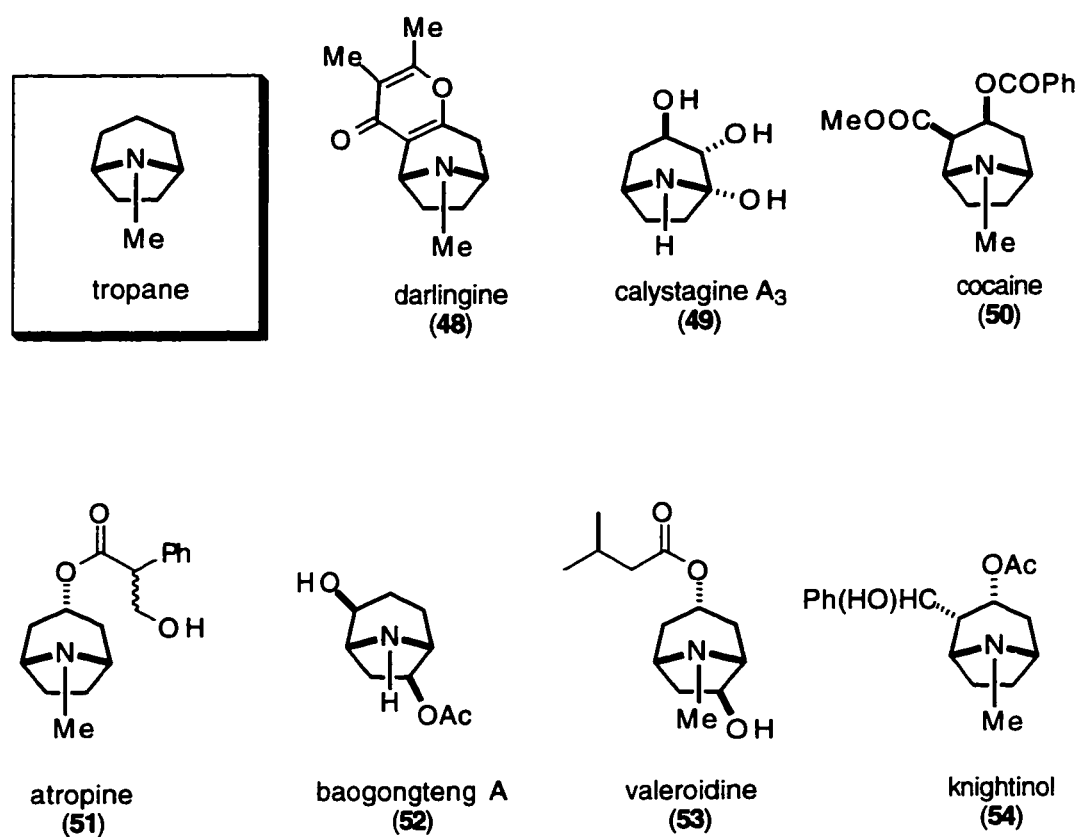

Fig. 1.6. Representative examples of tropane alkaloids

2.1 Synthesis of achiral alkaloids

Synthesis of tropinone without formation of C-C bonds

The bicyclic skeleton of tropinone can be synthesized from seven-membered carbocyclic precursors through addition of a nitrogen bridge. This route was used in the first Willstätter's synthesis of tropinone.^{38,39} This classic synthesis, from the end of 19th century, involved 20 steps and gave an overall yield of 0.75% based on cycloheptanone (Scheme 10).

Scheme 10

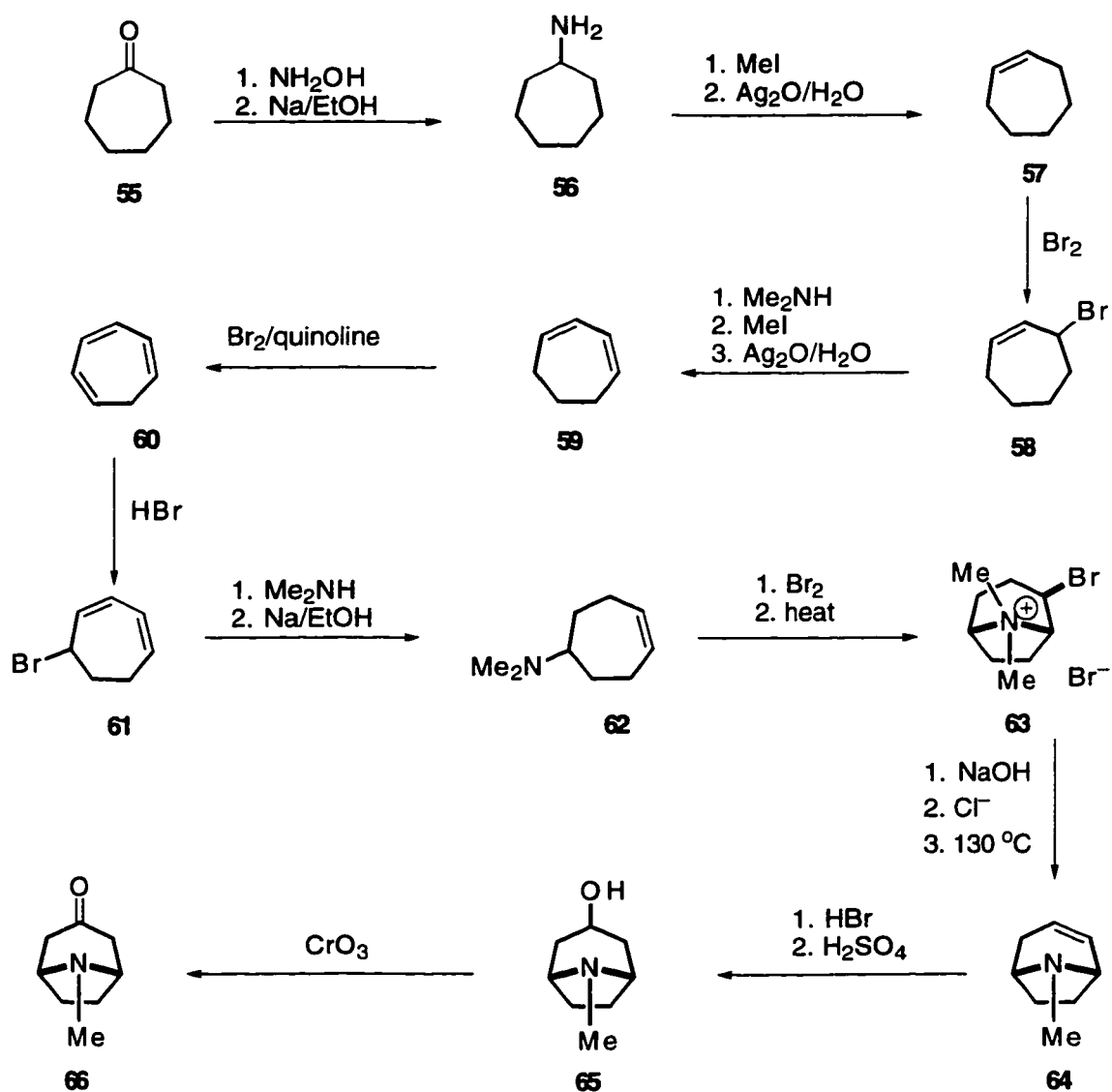

In the 1970s, many short syntheses of tropinone and other nitrogen substituted derivatives of nortropinone were accomplished by double Michael addition of amines to 2,6-cycloheptadienone (Scheme 11).⁴⁰⁻⁴³ The starting material, 2,6-cycloheptadienone (**67**), is easily accessible from cycloheptanone (**55**) via a four step procedure published by Garbisch.⁴⁵ Bottini and Gal obtained tropinone and its benzyl and ethyl analogs from 2,6-cycloheptadienone in a one step reaction.⁴⁰ The addition reaction was equally successful for *para* substituted anilines, hydroxamic acids, hydrazines, esters of aminoacids and other nucleophiles.^{42,43} Thus, the addition of primary amines to 2,6-cycloheptadienone is a general reaction leading to *N*-substituted nortropanes.

Scheme 11

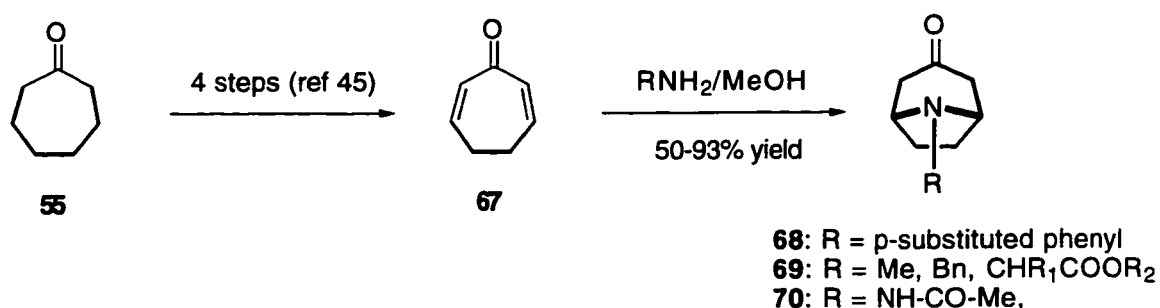

Synthesis of tropinone based on formation of C-C bonds

The first preparation of the tropane moiety from acyclic substrates was reported by Robinson in 1917. The original Robinson's synthesis involved a double Mannich reaction of succindialdehyde with methylamine and acetone or its synthetic equivalents: ethyl or calcium acetonedicarboxylates (Scheme 12).⁴⁶ Despite its amazing simplicity, the reaction with calcium acetonedicarboxylate gave 42% yield of tropinone isolated in a form of

dipiperonylidene derivative **66a**. One of the difficulties of the original Robinson synthesis was associated with preparation of the unstable succindialdehyde **72**, which was prepared by action of 'nitrous fumes' (N_2O_3) on succinaldoxime **71**.

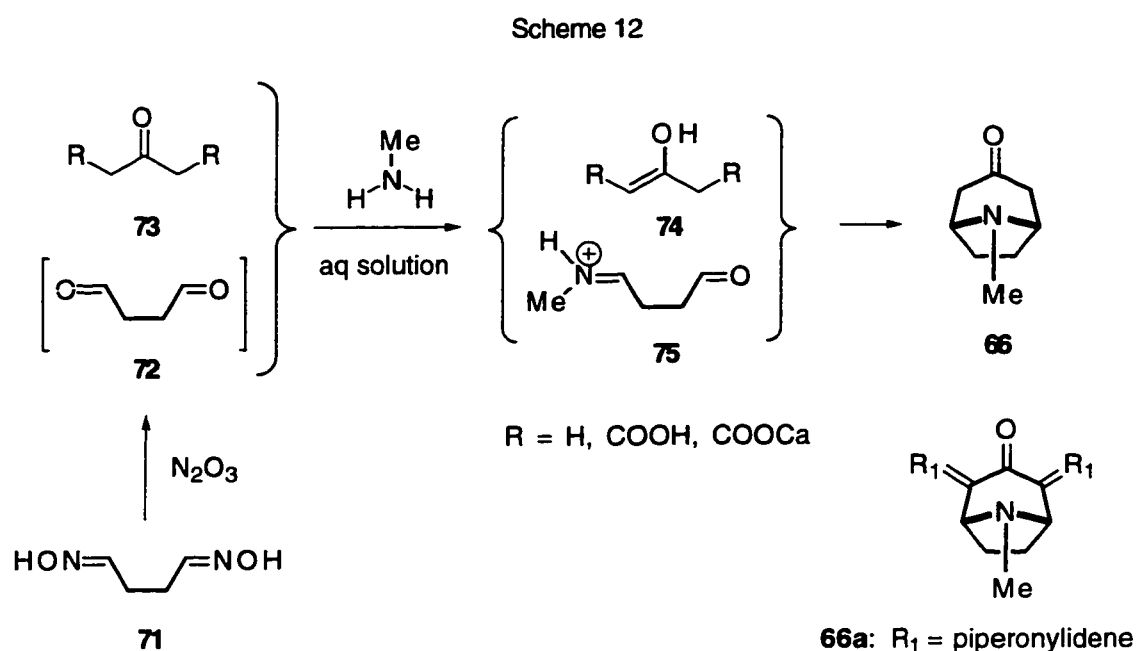

Later, Schöpf *et al.*⁴⁷⁻⁴⁹ were able to increase the yield of the Robinson synthesis to over 90% by careful optimization of the reaction conditions. Other *N*-alkyl derivatives of nortropinone were prepared through Robinson-Schöpf synthesis, in 41-58% yield, by Keagle and Hartung.⁵⁰ Willstätter also developed a synthesis of tropinone from acyclic precursors. In the second Willstätter's synthesis of tropinone the carbon-carbon bonds were constructed *via* the Kolbe electrolysis reaction and the Dieckmann condensation (Scheme 13).⁵¹ A similar strategy was used in Raphael's acetylenic route to tropinone (Scheme 14).⁵² After the pyrrolidine diester **78** was prepared, by carboxylation of organomagnesium derivative of diacetylene **80**, followed by esterification

and conjugate addition of methyl amine to **81**, the path followed the Willstätter's route.

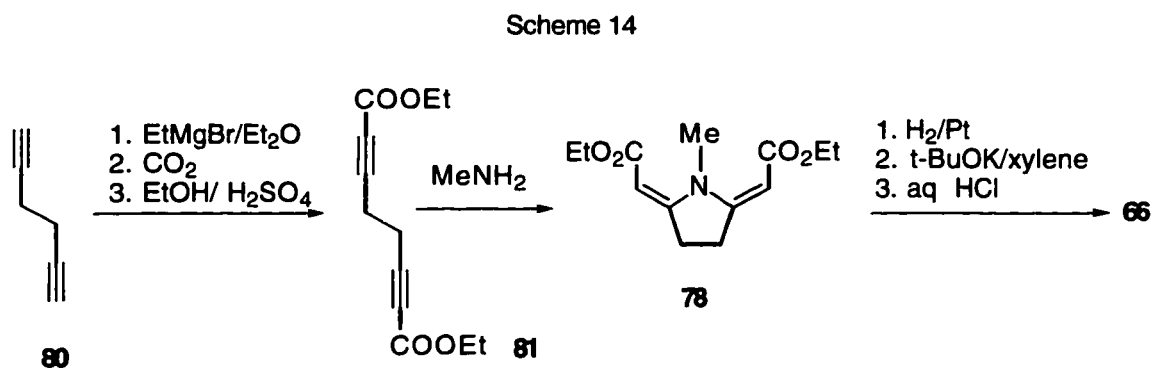
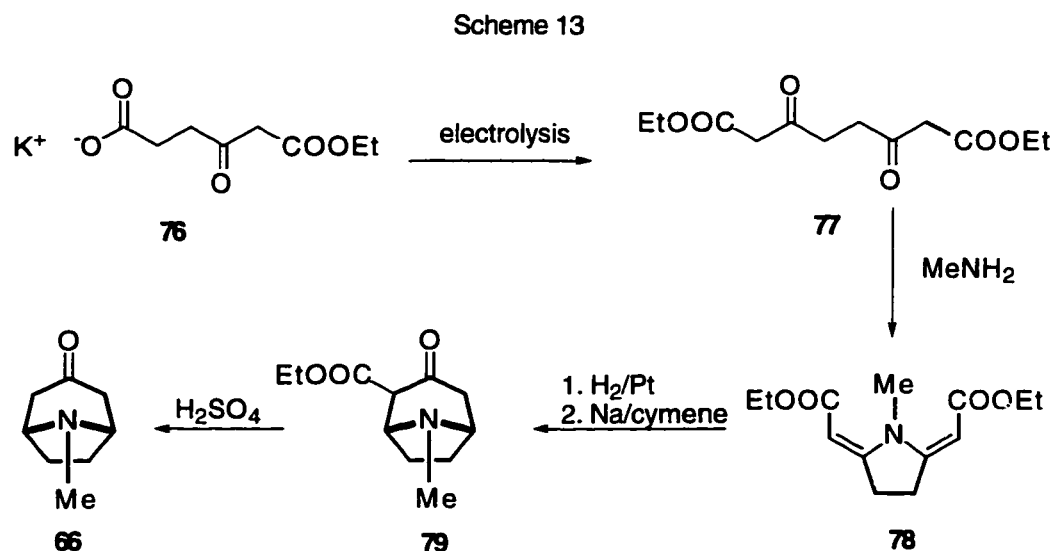

Recently, Lansbury obtained the tropinone carbon skeleton through a reaction of 1,4-dianion of the sulfone **82** with 3-iodo-2(iodomethyl)propene.⁵⁶ The product was subjected to ozonolysis and to reaction with aqueous-methanol solution of methylamine, which onset a cascade of reactions (two eliminations

and two Michael type addition) which led to tropinone in ca. 65% yield (Scheme 15).

Scheme 15

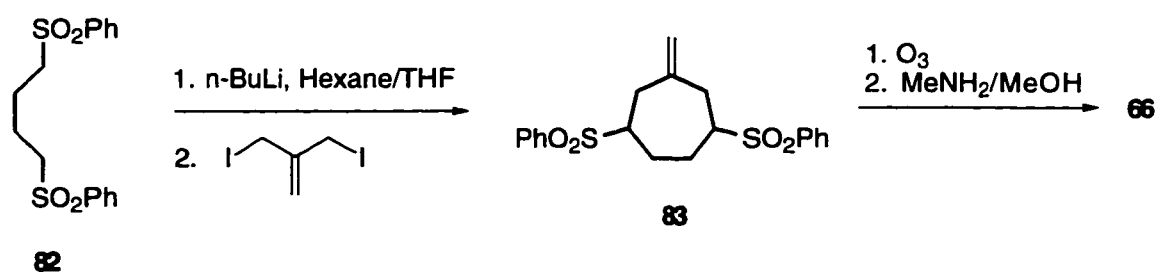

Stereoselective Reduction of Tropinone and Synthesis of 3-Substituted Tropanes

Diastereoselective reduction of tropinone (**66**) to tropine (**86**) and pseudotropine (**85**) (Scheme 16) was used in syntheses of alkaloids from the atropine series (3α -hydroxytropane esters) and from tropacocaine series (3β -hydroxytropane esters) respectively. The first reduction of tropinone to tropine was performed by Willstätter with an *endo/exo* selectivity of 5:2.¹²⁹ More recent selective methods are summarized in Table 1.1. The most *endo*-selective reaction was the hydrogenation on PtO_2 reported by Keagle and Hartung.⁵⁰ To explain the lowered selectivity of hydrogenation of *N*-ethoxycarbonyl nortropinone it was suggested that the stereoselectivity of hydrogenation depends not on the steric bias associated with the bicyclic structure of tropane skeleton but rather on the basicity of the nitrogen atom.¹³⁶

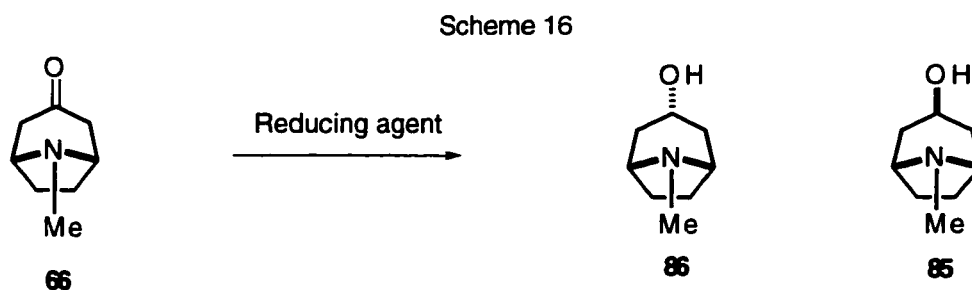
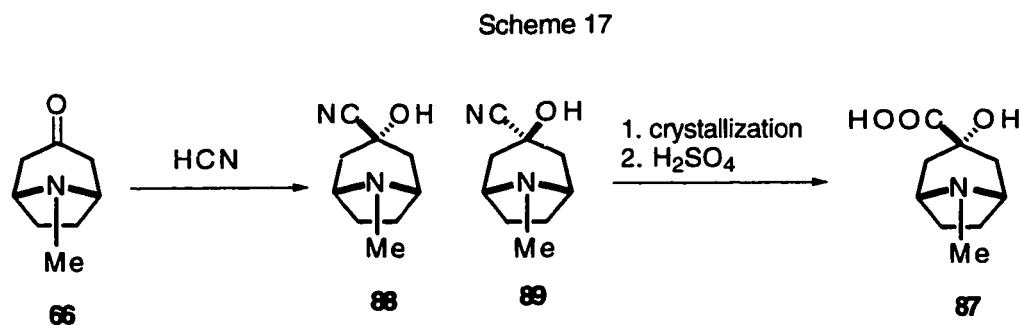

Table 1.1. Stereoselective reduction of tropinone (**66**)

Reducing reagent	86 : 85	reference
Zn/HI	5:2	129
Na/EtOH	1:24	53
Na/ <i>iso</i> -BuOH	1:27	53
H ₂ /PtO ₂ , EtOH	99.4:0.6	50
H ₂ /PtO ₂ , EtONa	12:1	53
NaBH ₄	54:46	127,128
DIBAL-H/THF	32:1	126

Approaches to symmetrical tropane derivatives

Several 3 α and 3 β substituted tropane derivatives were prepared by transformations of tropinone cyanohydrin.^{57,58} The α -ecgonine methyl ester was the first such product and was prepared by Willstätter *via* acid hydrolysis of tropinone cyanohydrin (Scheme 17).⁵⁵



Both Cignarella *et al.*,⁵⁵ and later Daum *et al.*,⁵⁴ also used the hydrolysis of 3-cyanotropane derivatives to prepare 3,3-disubstituted tropanes (Scheme 18). The tropane moiety however, was constructed in a reaction of the benzyl cyanide carbanion with *N*-tosyl pyrrolidine **92a**, or its *N*-benzyl analog **92b**.

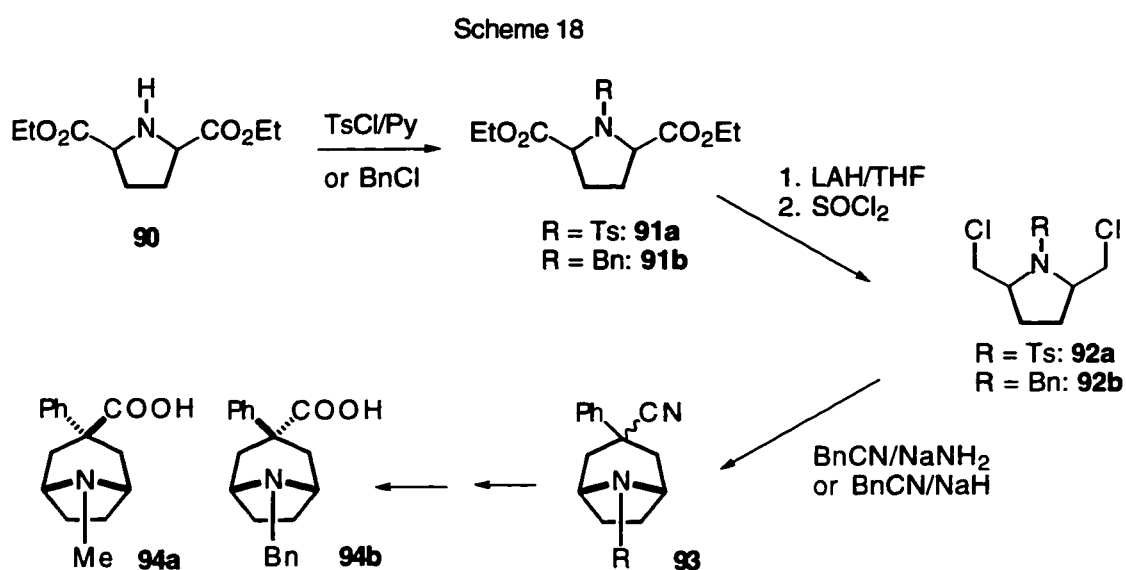

The stereoselectivities of these reactions were low and the products had to be separated by fractional crystallization of their HCl salts. The *endo* nitrile was the major product obtained in the reaction of the *N*-benzyl analog **92b** with BnCN/NaH in DMF (*endo/exo* nitrile 3:1).⁵⁴

An interesting approach to the synthesis of pseudotropine was used by Tufariello.⁵⁹ The conjugate addition of 4-nitrobut-1-ene (**95**) to acrolein in methanol gave the nitro-acetal **96**, which was reduced to the unsaturated nitron **97** (Scheme 19). Thermal cyclization of the nitron afforded the cycloadduct **98**, the structure of which ensured the *exo*-orientation of the hydroxy group in the final 3-hydroxytropane product. Methylation of the cycloadduct (isoxazolidine **99**) with methyl iodide and reduction of the

resulting quaternary salt with LiAlH_4 finished the stereoselective synthesis of pseudotropine (**85**).

Scheme 19

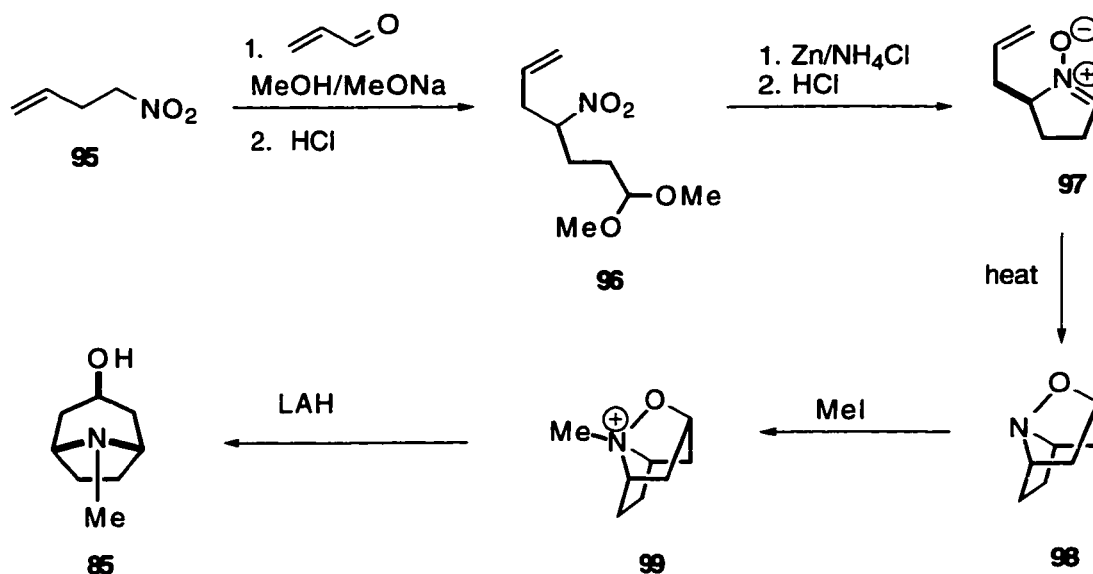

Diastereodivergent syntheses of scopine (**111**), tropine (**86**), pseudoscopine (**112**) and pseudotropine (**85**) based on palladium catalyzed reactions were recently developed by Bäckvall *et al.* (Scheme 20).^{60,61} The palladium catalyzed 1,4-chloroacetylation of diene **100** gave regioselectively the key intermediate **101**. The relative configuration of the 3-hydroxy group in the tropane product was controlled by diastereoselective substitution of allylic chlorine with retention (Pd catalyzed substitution) or inversion ($\text{S}_{\text{N}}2$ type substitution) of configuration respectively. The diastereoselective epoxidation relied on the *syn*-directing effect of the sulfonamido group in **105** and **106**. A similar strategy was used in syntheses of pseudoscopine and scopine by both Malpass⁶⁴⁻⁶⁷ and earlier by Kibayashi *et al.* (Scheme 21).^{62,63} Kibayashi's diastereoselective nitroso Diels-Alder cycloaddition of a derivative of 1,3-cycloheptadiene followed by reductive fission of the N-O bond provided

Scheme 20

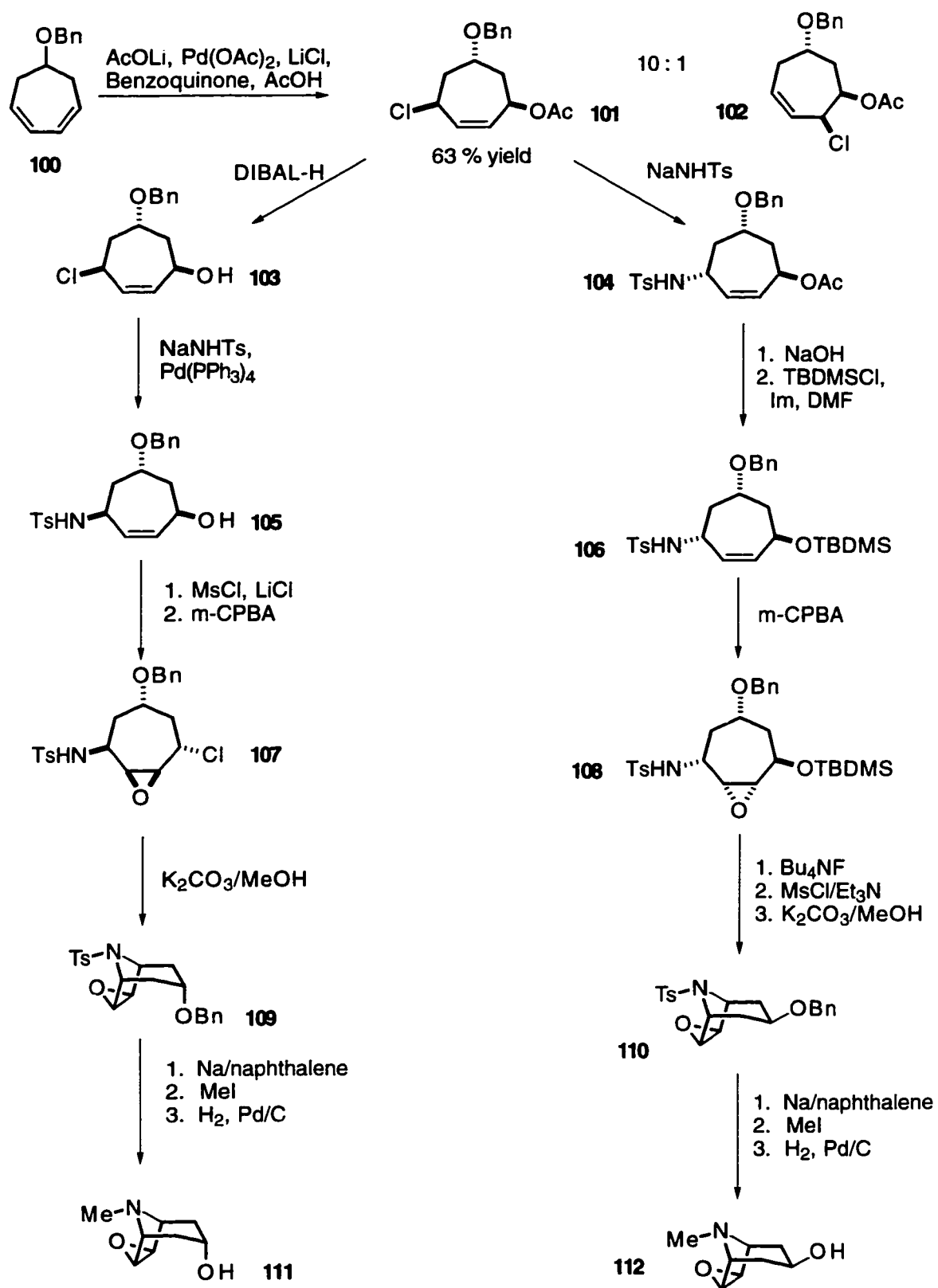

the intermediate **115** (Scheme 21). The intermediate **115** was transformed into carbamates **116a** and **116b**, which underwent base induced amidocyclization to **117a** and **117b** respectively. These pseudotropine derivatives were further manipulated to tropine (**86**) and tropacocaine (**118**) (Scheme 21).

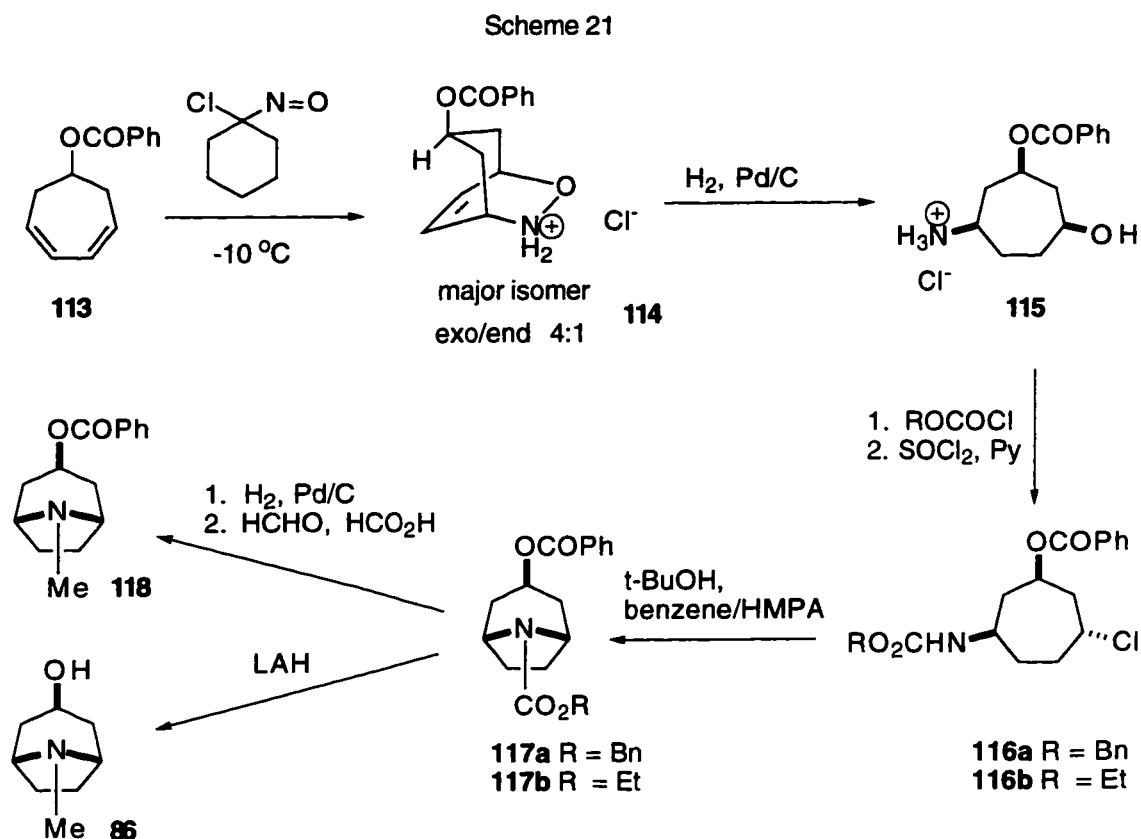

2.2. Synthesis of chiral alkaloids in racemic form

A recent review by Lounasmaa and Tamminen lists 203 tropane alkaloids of which about 60% are chiral.³³ Dissymmetry of many of the known tropane alkaloids comes from the non-symmetrically substituted tropane skeleton. All the early total syntheses of chiral tropane derivatives resulted in racemic products, unless resolution was incorporated into the synthetic pathway.

Strategies based on construction of tropane skeleton

The synthesis of 6-hydroxytropinone, the intermediate for valeroidine type alkaloids, was accomplished by a modification of the Robinson-Schöpf synthesis. The modification, reported by Stoll,^{69,70} included the use of a synthetic equivalent of hydroxysuccindialdehyde: a 4-hydroxy-2,5-dialkoxytetrahydrofuran **124** (Scheme 22). The tetrahydrofuran derivative **124**, which undergoes acid hydrolysis to the dialdehyde **126**, was prepared from 2,5-dialkoxy-2,5-dihydrofuran **122a** through the addition of hypobromic acid and reductive debromination.

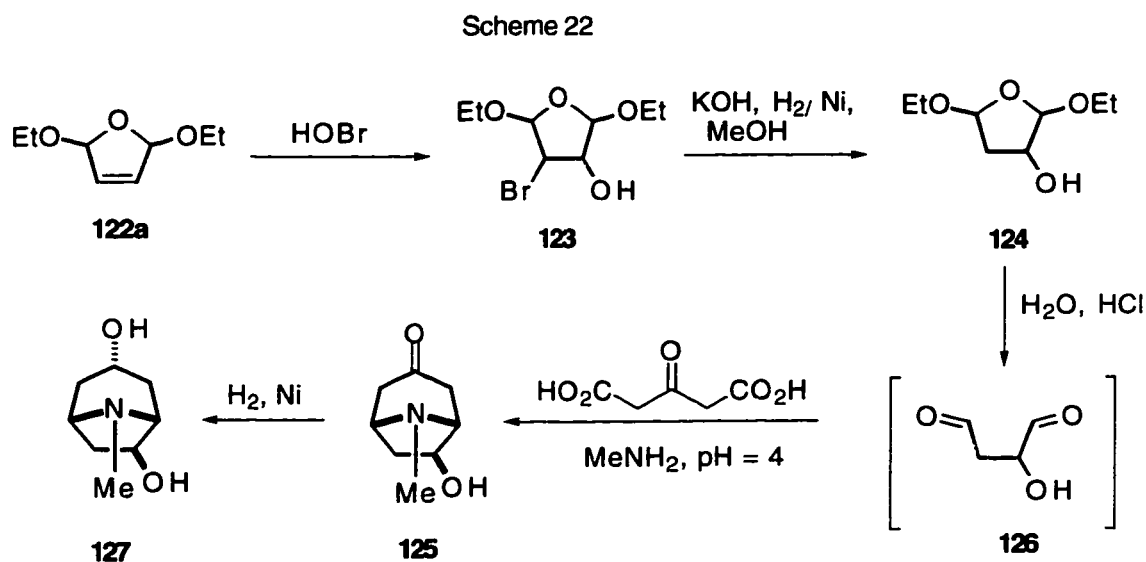

The same strategy was shown by Clauson-Kaas to be successful for the preparation of 6-hydroxytropinone (isolated as picrate in 55% yield) when the

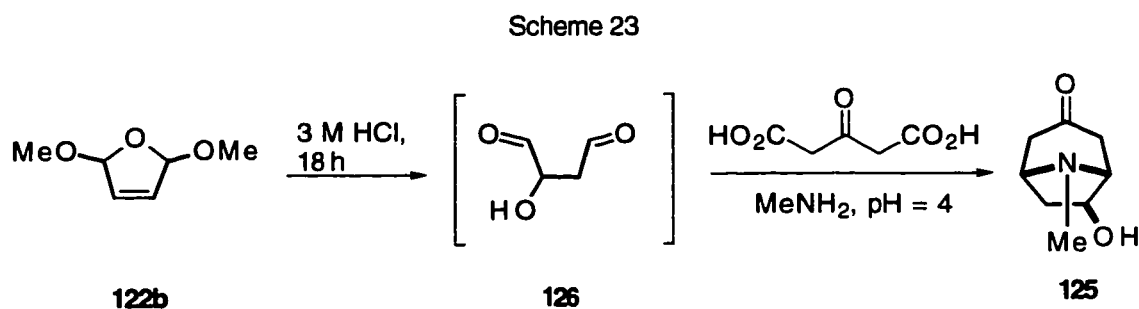

procedure was shortened to two steps thanks to the *in situ* generation of hydroxysuccindialdehyde (**126**) from **122b** (Scheme 23).⁶⁸ The racemic 6-hydroxytropinone (**125**) was used as a starting material for several syntheses of racemic alkaloids. For example, Fodor used this compound in the first synthesis of valeroidine (Scheme 24).⁷¹ The 6-hydroxy group was first protected as the phenylcarbamate. After hydrogenation and esterification with isovaleryl chloride, the 6-hydroxyl group was deprotected thermally. In the same study, several synthetically interesting intermediates were prepared. They included "tropine oxide" **134** and 6-tropen-3-yl acetate **133**.

Scheme 24

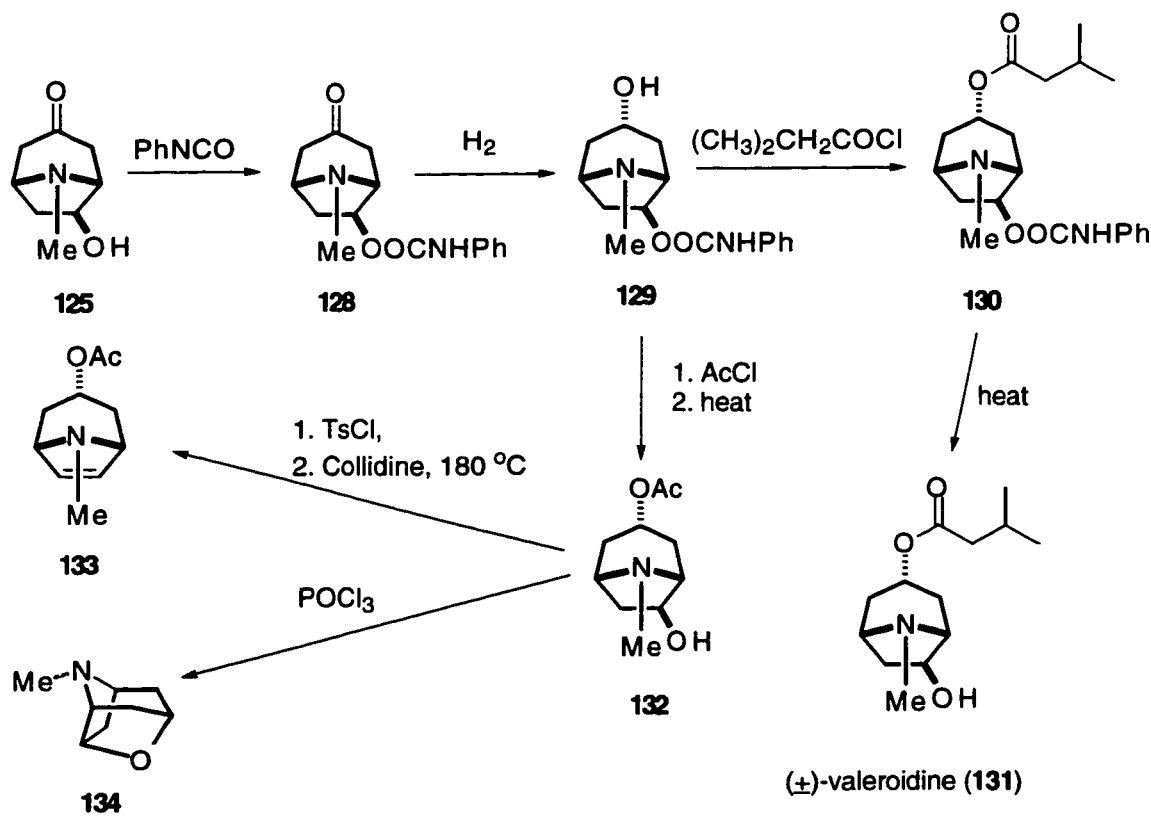

6-Acetoxytropinone (**135**) was used as the starting material in the synthesis of baogongteng A (**140**) reported by Xiang *et al.*⁷² The Chinese synthesis (Scheme 25) included a multistep 1,2-carbonyl transposition, reduction of the transposed carbonyl group to the *exo* alcohol, and demethylation with 2,2,2-trichloroethyl chloroformate.

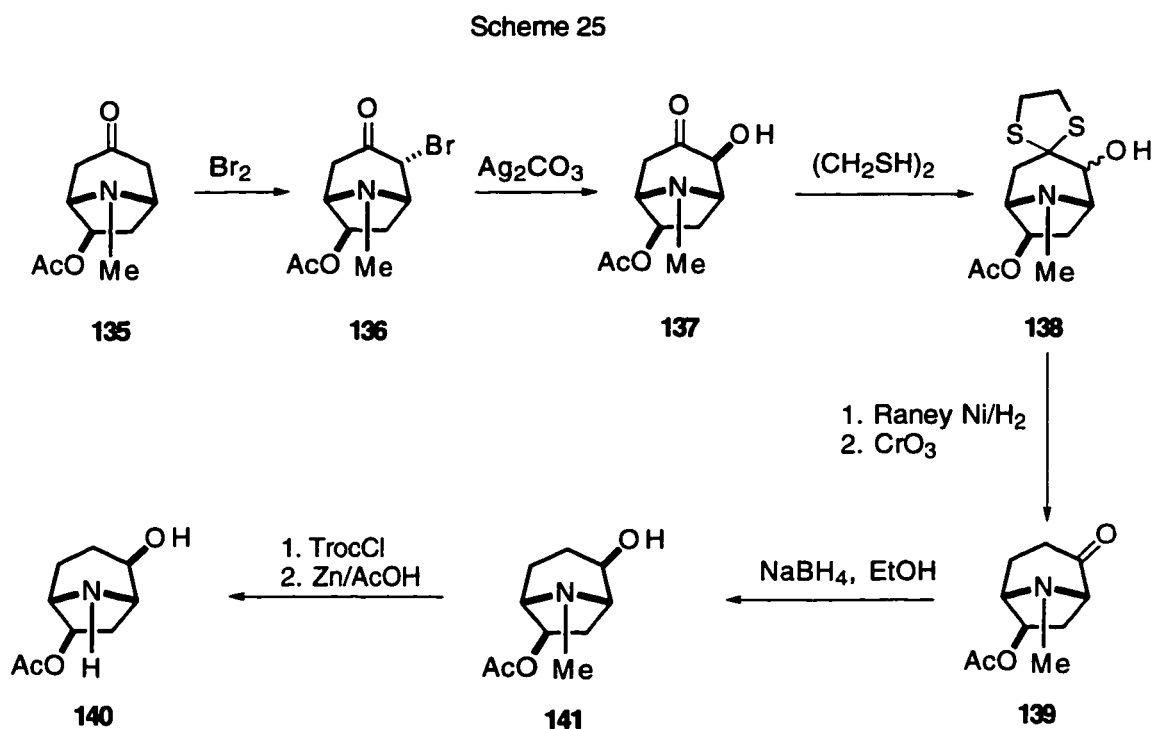

Racemic baogongteng A (**140**) was also synthesized by Jung *et al.*⁷³ via the 1,3-dipolar addition reaction developed earlier by Katritzky. Katritzky and Takeuchi observed the formation of two cycloadducts, **143** and **144**, in a reaction of 1-methyl-3-oxopyridinium (**145**) with methyl acrylate and acrylonitrile respectively.⁷⁴ While the addition of methyl acrylate was non stereoselective, the reaction with acrylonitrile took place with high *exo*-stereoselectivity, thus opening a route to baogongteng A (Scheme 26).

Scheme 26

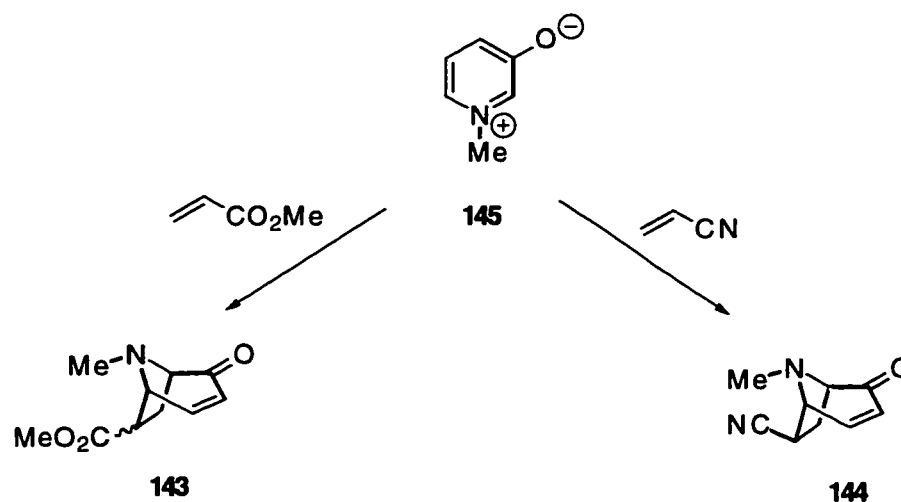

However, when a benzyl analog of **145** (1-benzyl-3-hydroxypyridinium betaine) was used in the cycloaddition reaction with acrylonitrile, no selectivity was observed and the reaction resulted in a 1:1 mixture of diastereomers, as indicated by NMR and IR.⁷⁵ Jung *et al.* repeated the reaction using 1-benzyl-3-hydroxypyridinium bromide (**146**) and prepared a 2:3 mixture of the *exo* and *endo* cycloadducts **147a** and **147b**, which were chromatographically separated (Scheme 27).⁷³ The desired *exo*-isomer was transformed into the silyl ether of the corresponding axial alcohol (**149**) *via* the diastereoselective reduction with sodium borohydride followed by the reaction with TMS chloride. The *exo* cyanide group was then converted to the acetoxy group through addition of a Grignard reagent to give the ketone **150** followed by a Baeyer-Villiger rearrangement. Hydrogenolysis removed the benzyl group and completed the synthesis of **140**.

Scheme 27

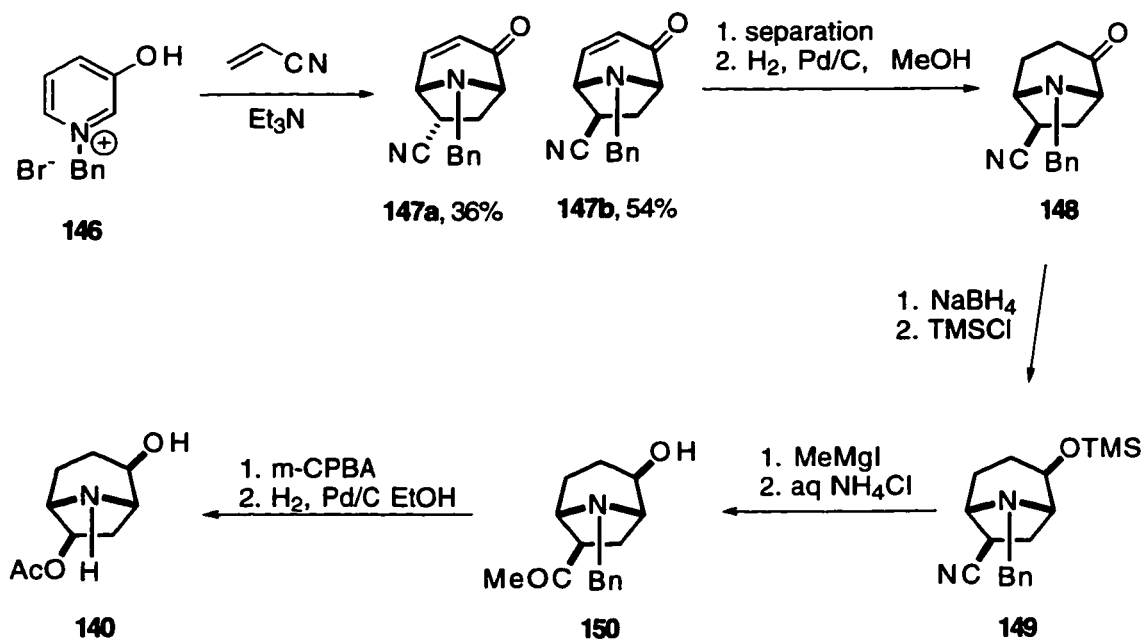

Tufariello used a 1,3-dipolar addition of the nitron **151** in an elegant synthesis of racemic cocaine (**160**) (Scheme 28).⁷⁶⁻⁷⁹ The isoxazolidine **152**, which was prepared by addition of methyl 3-butenate to 1-pyrrolidine-1-oxide with high regioselectivity, was oxidized to the nitron **153**. Before the elimination of water from the hydroxyester group in **153**, the nitron functionality had to be protected in a form of a cycloadduct **154**. The protected nitron underwent thermal retrocycloaddition reaction accompanied by a concomitant intramolecular cycloaddition to form the tricyclic product **158**. After the alkylation of the tricyclic product with methyl iodide, the resulting methiodide **159** was subjected to reductive cleavage of the N-O bond to afford ecgonine methyl ester (**161**). The ester **161** was converted to cocaine (**160**) *via* a standard benzoylation reaction.

Scheme 28

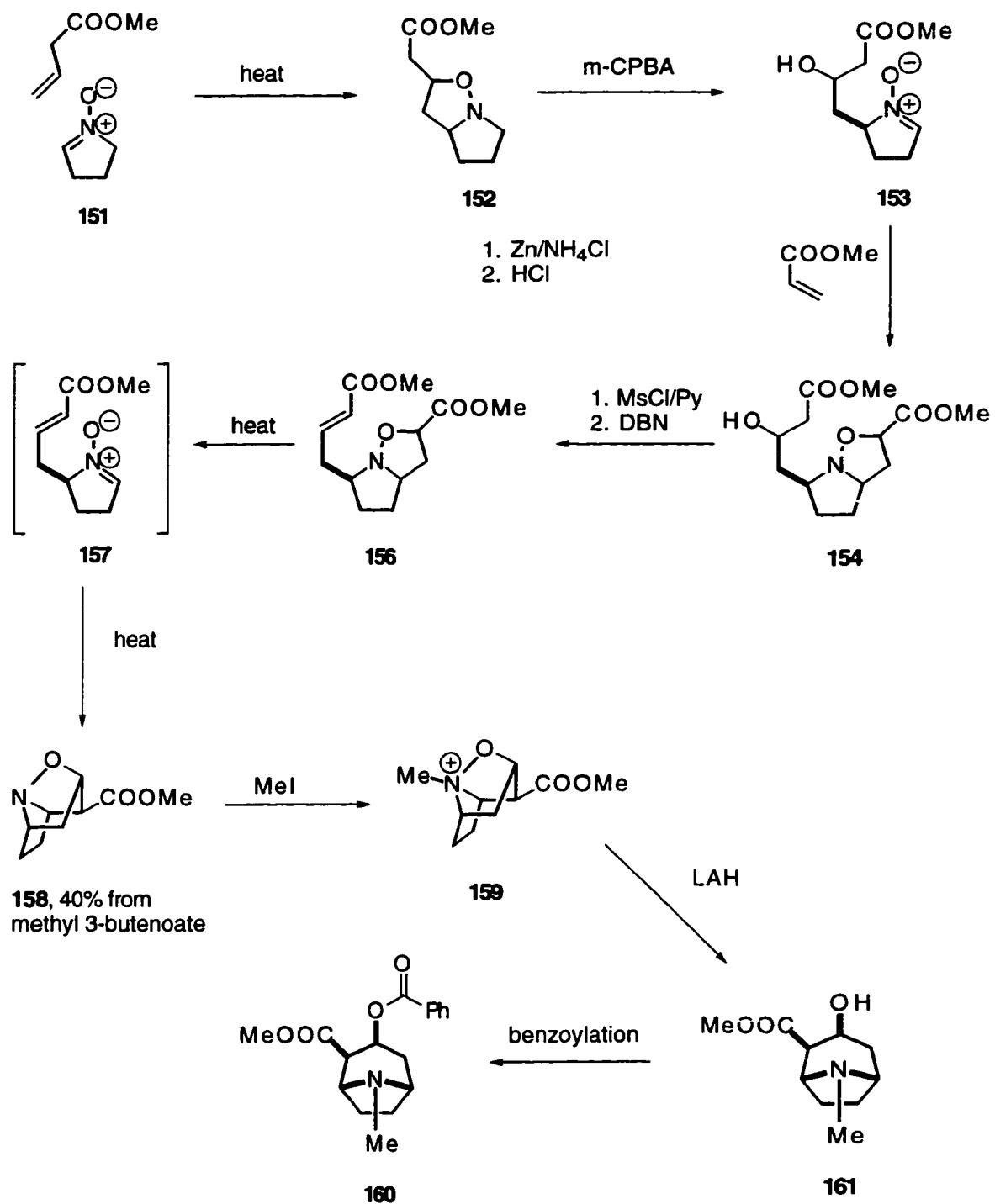

Rhodium catalyzed reaction of vinylcarbenoids, prepared by decomposition of vinyl diazomethanes bearing an electron-withdrawing group in the presence of (*N*-alkoxycarbonyl)pyrroles was used by Davies *et al.* in a

synthesis of racemic anhydroecgonine methyl ester (**170a**) and ferruginine (**170b**, Scheme 30).⁸⁰⁻⁸² When 2-diazo-3-butenoate was used in the rhodium acetate catalyzed reaction with methoxycarbonylpyrrole an almost 1:1 mixture of two products, **162** and **163** was obtained (Scheme 29). However when the reaction was run in an apolar solvent (hexane instead of CH_2Cl_2) and catalyzed with rhodium hexanoate, the product **162** predominated (selectivity better than 95:5 was reported). This observation was then applied to the short synthesis of ferruginine **170b** and anhydroecgonine methyl ester **170a** (Scheme 30).

Scheme 29

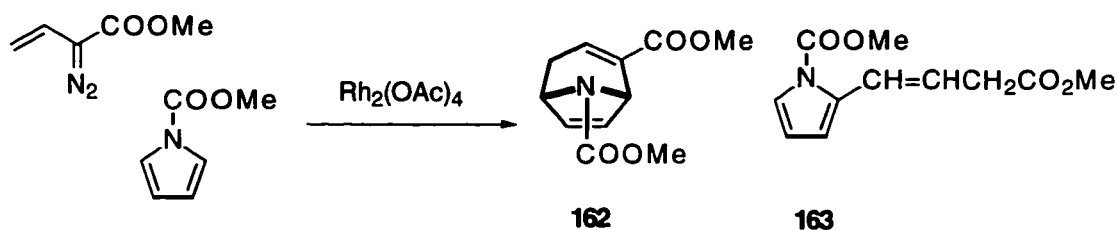

Scheme 30

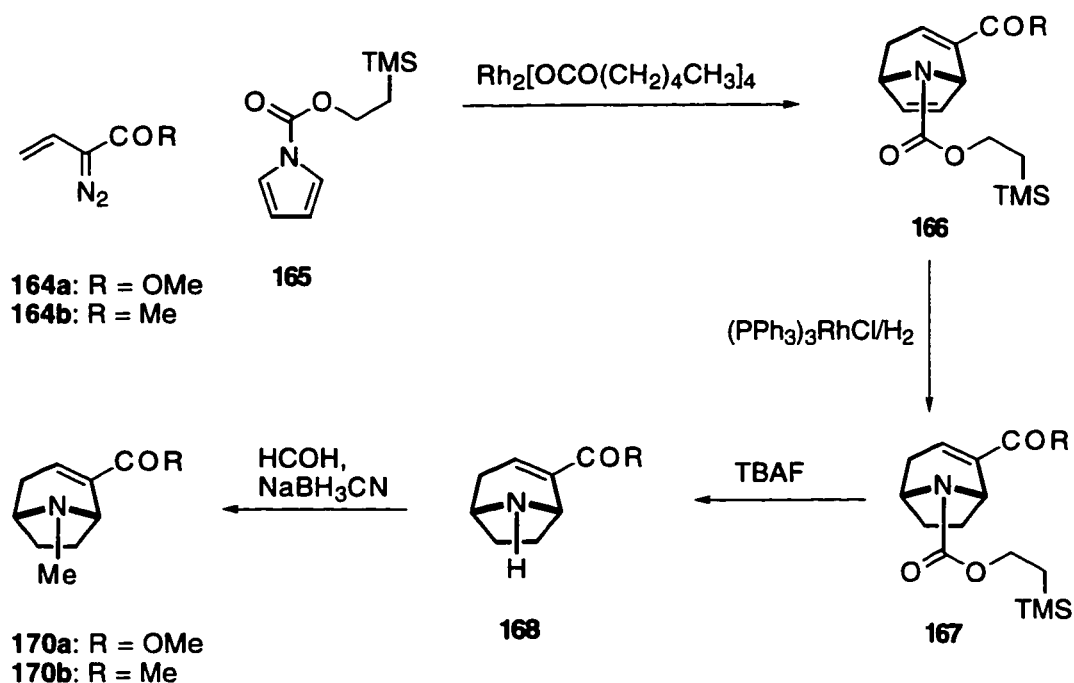

In another approach, by Rettig, 1,4-cycloheptadiene was converted to alkoxy carbonyl derivatives of nortropidine *via* a reaction with alkyl azidoformate and dichlorobis(benzonitrile)palladium(II) catalyzed rearrangement of the resulting aziridines (Scheme 31).⁴⁴

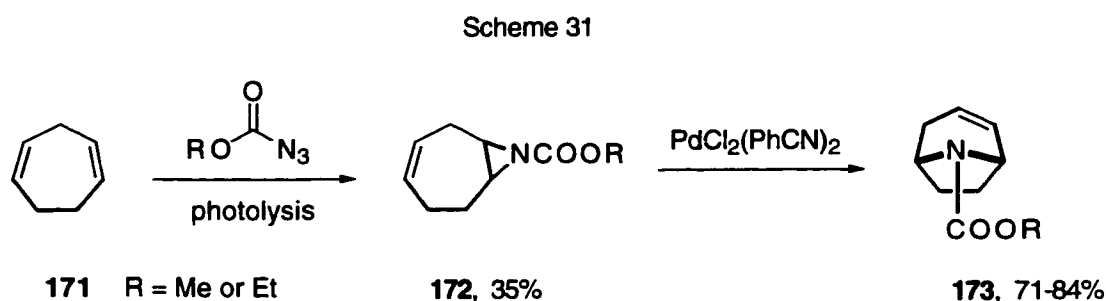

Two methods for obtaining 4-functionalized tropan-6-ones, based on aziridine intermediates, were developed by Japanese chemists. Furuya and Okamoto⁸³ prepared the aziridine **176** from nortropinone and showed that the aziridine reacted with variety of reagents to afford nortropane derivatives **177** (Scheme 32). Representative examples are shown in Table 1.2.

The preparation of tropanone derivatives **183** and **184** from aziridine **180** was reported by Nagata.⁸⁴ The aziridine is readily available from the acid azide **178** (Scheme 33).

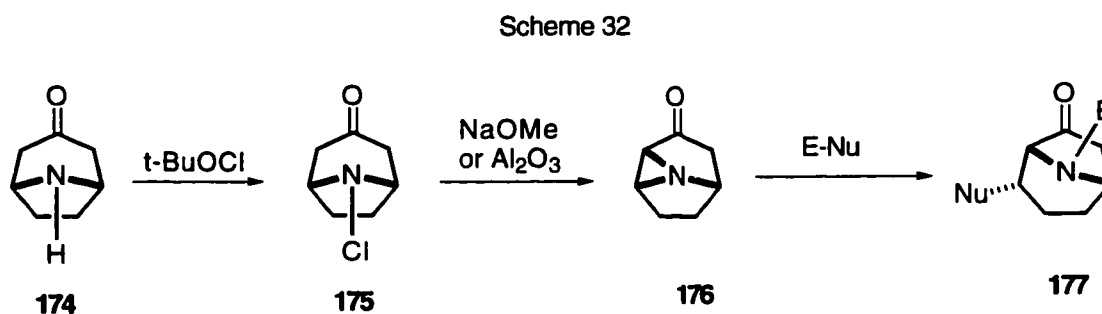
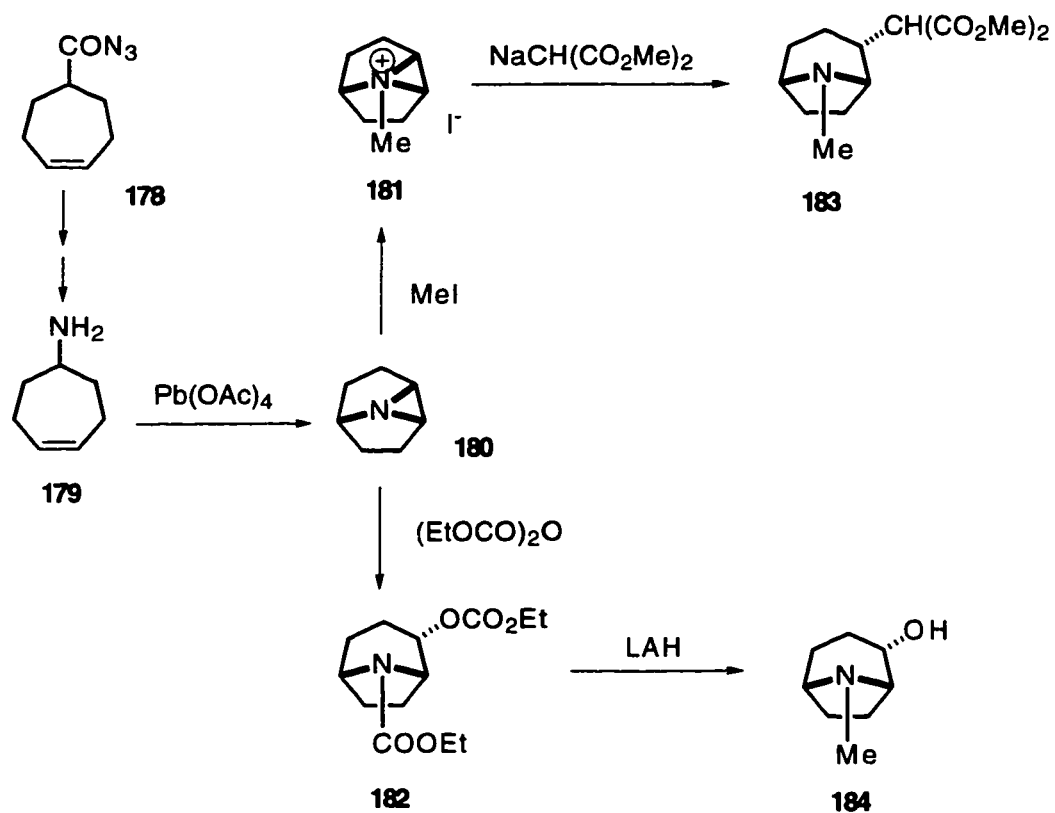

Table 1.2. Examples of Furuya and Okamoto transformations

entry	E	Nu	Yield of 177
a	Ts	Cl	36
b	Cl	Cl	80
c	CN	Br	71
d	Ms	Cl	58
e	Ac	Cl	72
f	Ac	OH	32
g	Ac	OAc	66

Scheme 33



6-Tropen-3-one is a useful intermediate for the synthesis of derivatives of scopine (193) and 6-hydroxytropine (190). A few methods based on the

addition of oxyallyls to activated *N*-substituted pyrroles are now available for construction of 6-tropen-3-one moiety. The first example of this strategy, reported by Turro and Edelson, was the simple preparation of 2,2-dimethyltropinone through a reaction of 2,2-dimethylcyclopropanone with *N*-methylpyrrole followed by the hydrogenation of the adduct **186** (Scheme 34).⁸⁵

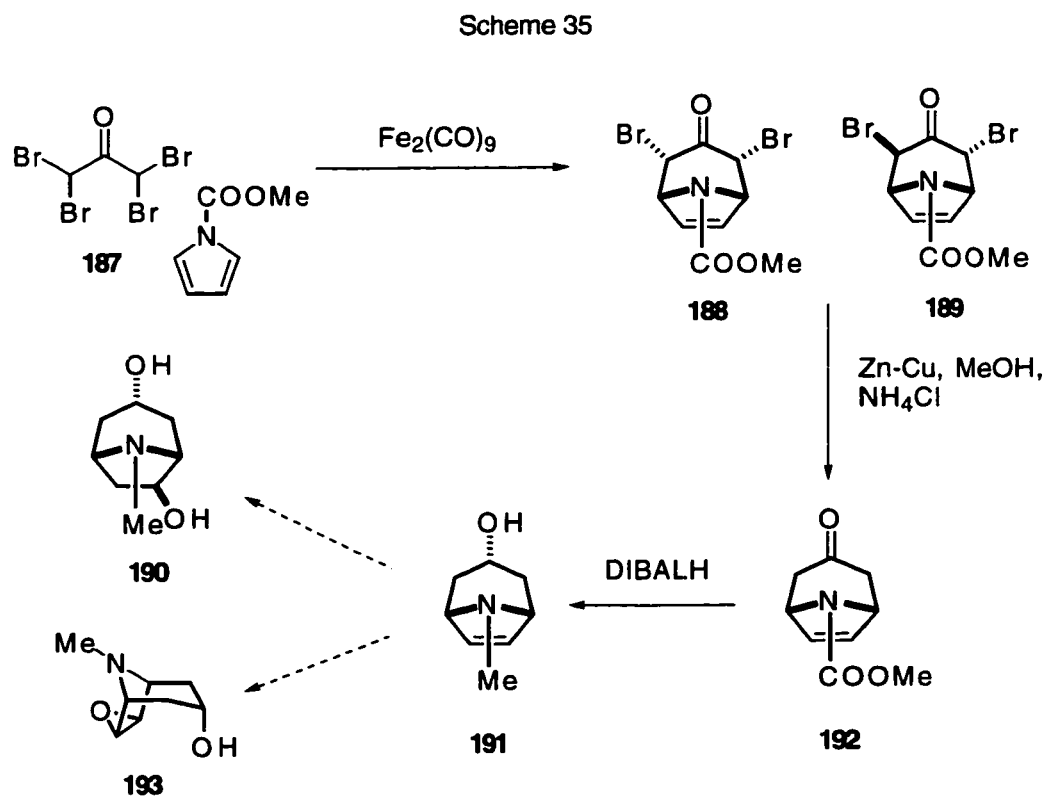
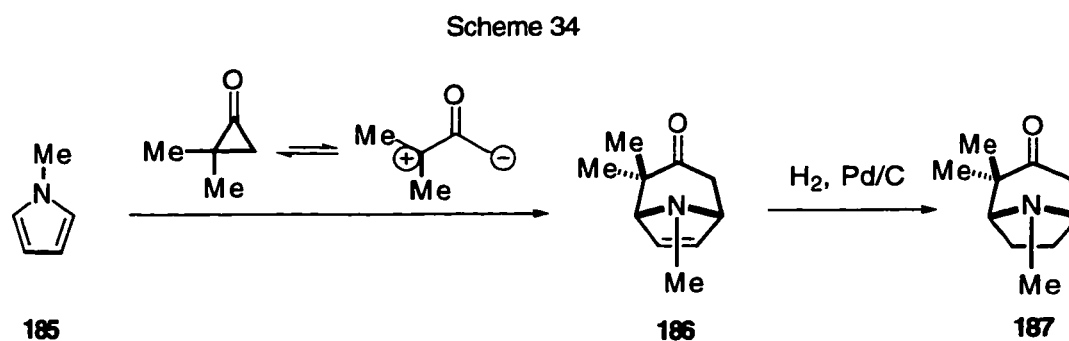

Later, Noyori applied the iron carbonyl-promoted coupling reaction of α,α' -dibromoketones and 1,3-dienes to the preparation of a useful precursor to $3\alpha,6\beta$ -tropanediol **191**.^{134,135} Since the reaction between α,α' -dibromoacetone and *N*-methylpyrrole led to an undesired electrophilic substitution reaction, tetrabromoacetone and *N*-carbomethoxypyrrole had to be used. The reaction furnished a 2:1 mixture of bromoketones **188** and **189**, which were transformed without separation to **191** (Scheme 35). Mann and de Almeida Barbosa have reported a more economical version of the same synthesis based on the generation of an oxyallyl with diethylzinc (Scheme 36).⁹² Epoxidation of **192** with *m*-CPBA and reduction with DIBAL-H completed synthesis of scopoline **194**. Similar to the above methods synthesis of non-natural derivatives of tropinone was achieved by Hoffmann (Scheme 37).⁹³

Scheme 36

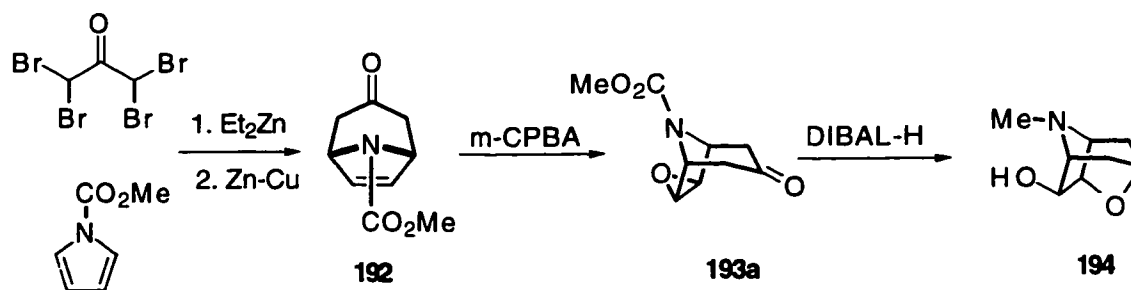

Scheme 37

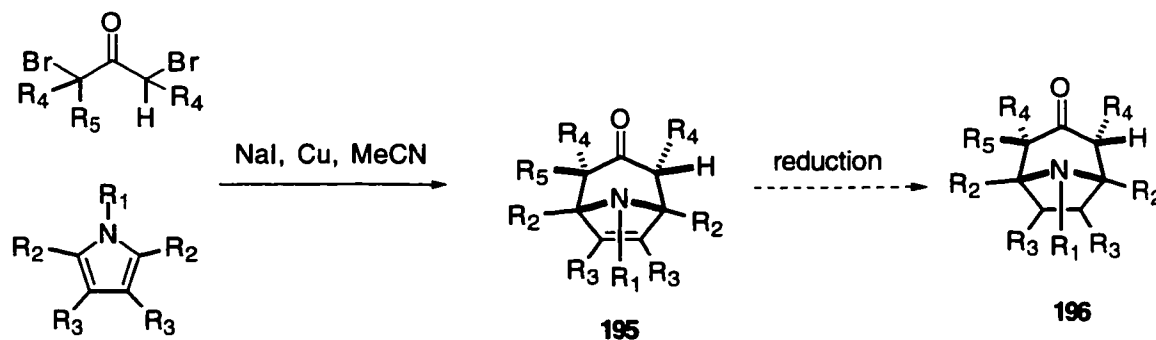

An interesting preparation of tropinone and asymmetrical analogs of tropanes, from 2-cyclohexenones, was developed by MacDonald and Dolan.⁹⁴ The addition of dichlorocarbene was used to expand the six-membered ring and double Michael type addition was used to build the tropane skeleton (Scheme 38).

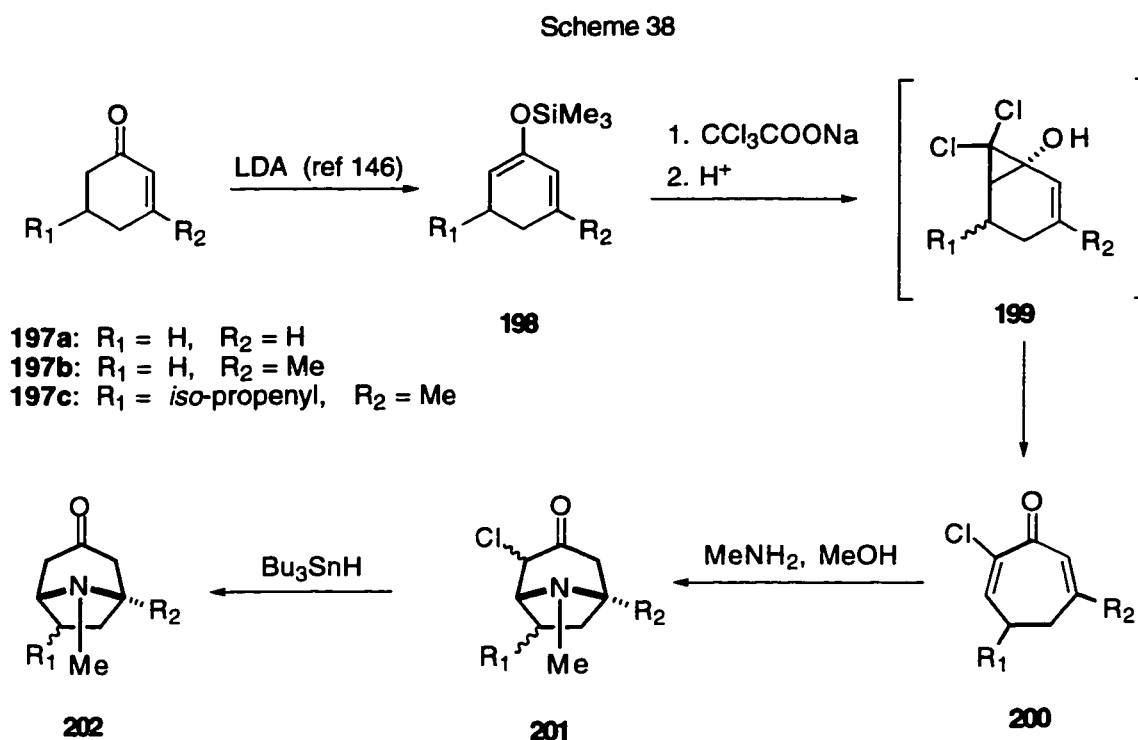

Synthesis of calystegine A₃ and its 3 diastereoisomers was achieved by Lallemand *et al.* via a ring enlargement methodology.⁹⁵ The silyl enol ether **207**, which was prepared from the commercially available 4-aminocyclohexanol hydrochloride, was transformed to the key intermediate **209** through cyclopropanation followed by cleavage of the three membered ring with FeCl_3 , and dehydrochlorination with sodium acetate (Scheme 39). Cis-dihydroxylation (OsO_4/NMO) and *trans*-dihydroxylation (epoxide opening) of the intermediate **209** gave mixtures of **210** with **211** and mixture **212** with

Scheme 39

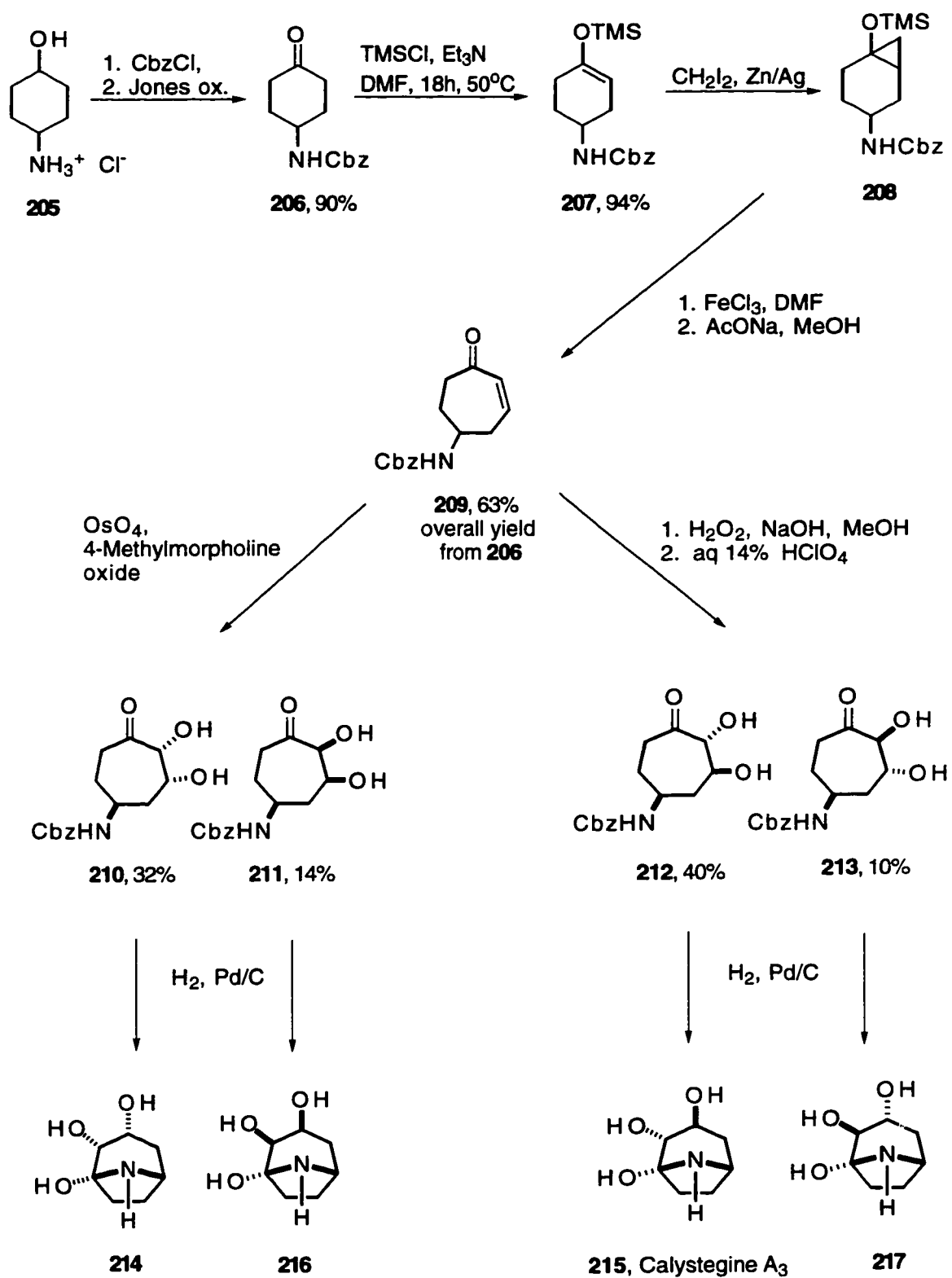

214 respectively. The chromatographic separation of each of the mixtures followed by hydrogenolysis of the amine protecting group led to the preparation of four 1,2,3-trihydroxynortropans **214-217**, one of which corresponded to calystegine A₃.

Strategies based on functionalization of the tropane skeleton

Since tropinone is now a relatively inexpensive, commercially available compound, many recent syntheses of tropane derivatives were based on functionalization and transformation of the tropinone molecule. All the synthetic approaches involve reactions of tropinone enolate, or its synthetic equivalents, with electrophilic reagents. For instance, Bick has obtained racemic bellendine (**221**) and isobellendine (**223**) by acylation of tropinone with acid chlorides followed by cyclization under acidic conditions (Scheme 40).^{86,87} Yields of these products were probably very low and were not reported.

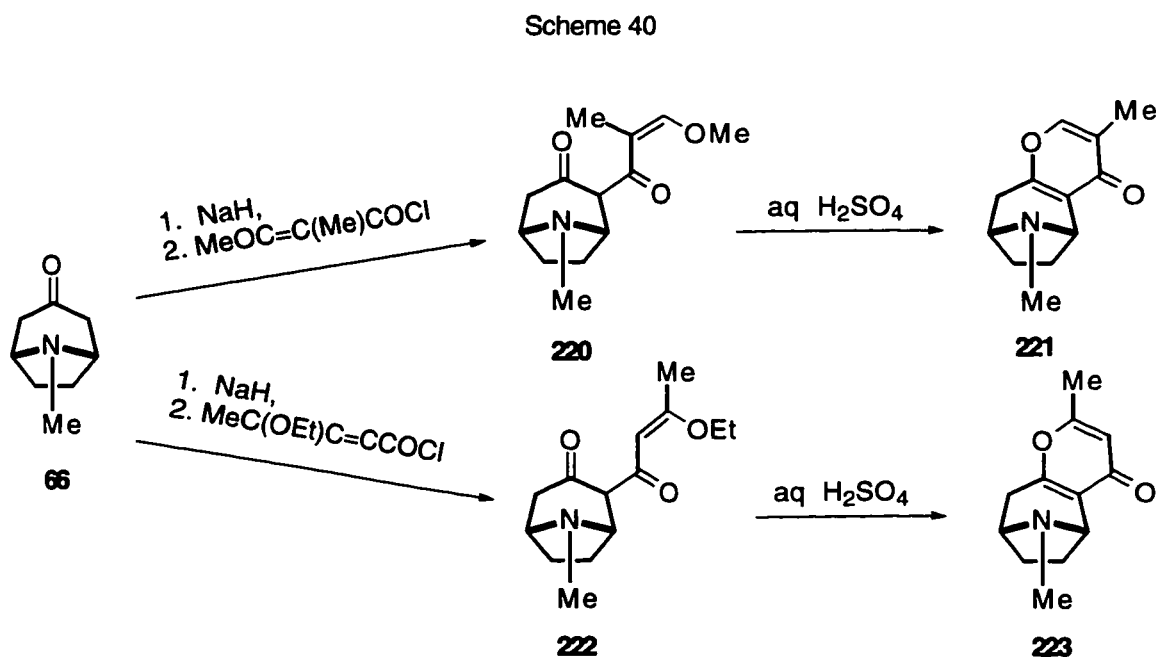

Racemic isobellendine was synthesized in a more efficient way, by Lounasmaa, *via* a reaction of tropinone enamine with diketene (Scheme 41).⁸⁸ The same author reported short syntheses of chalcostrobamine and strobamine,^{89a} as well as knightinol, acetylknightinol, and dihydro-2,3-darlingine⁹⁰ *via* acylation of tropinone with acyl cyanides (Scheme 42).

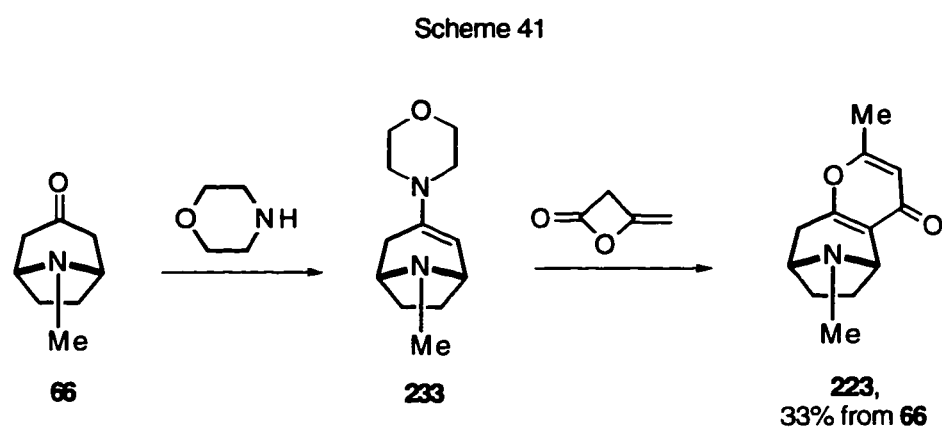

The syntheses shown in Scheme 42 were aimed at confirmation of connectivity of the natural products and thus issues of stereoselectivity were not addressed at all. For example, products **225**, **230**, and **231** were obtained as mixtures of several isomers which had to be separated. The natural isomers were prepared in low yields (often not reported). These approaches deserve credit because of their pioneering nature, but except for the synthesis of isobellendine (Scheme 42), failed as viable synthesis.

Scheme 42

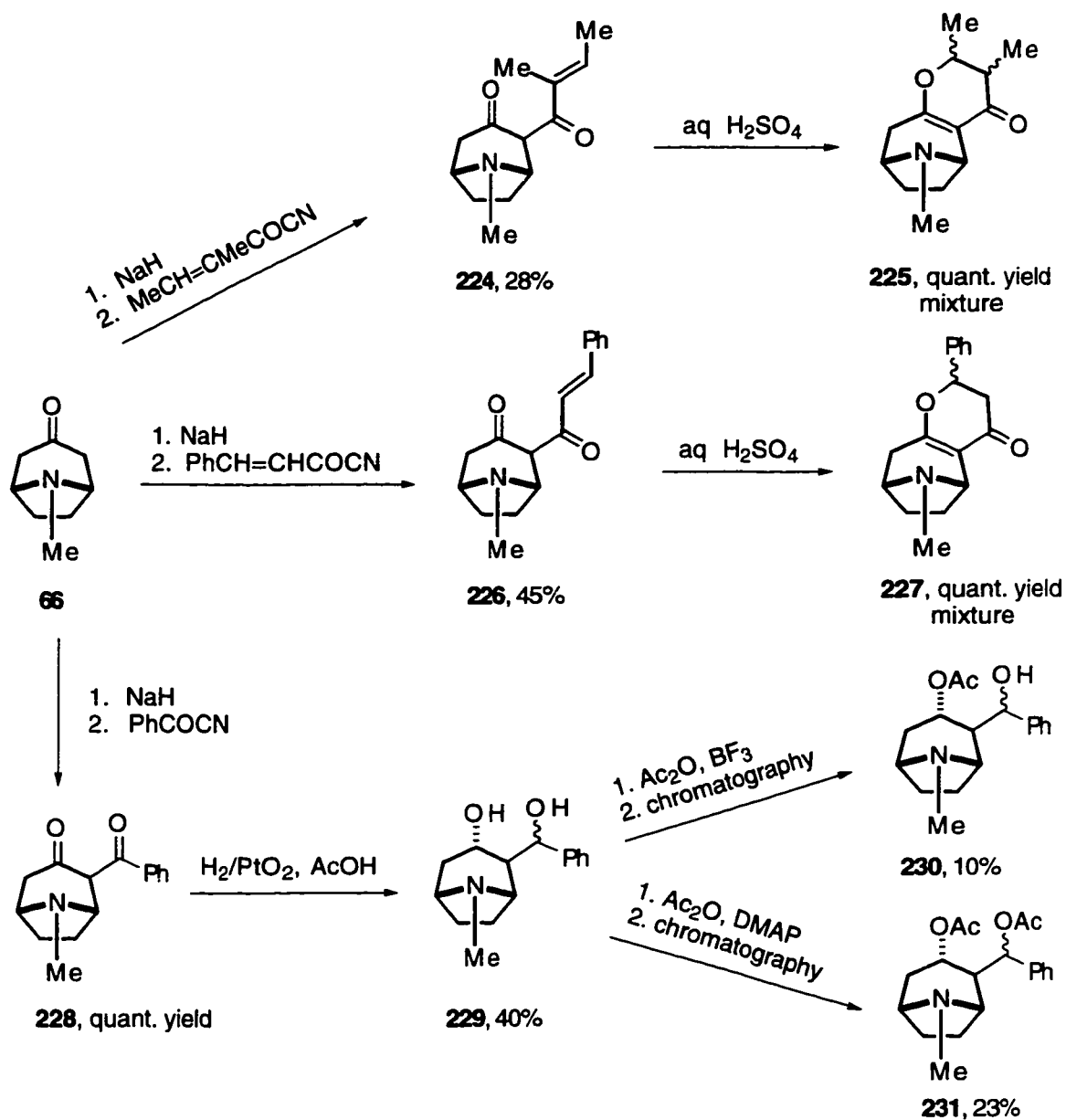

Similarly the approaches to synthesis of alkaloids KD-B (**219**) and KD-A (**220**) did not take into account any aspects of stereochemical control and resulted in mixtures of isomers (Scheme 43).^{91a}

Scheme 43

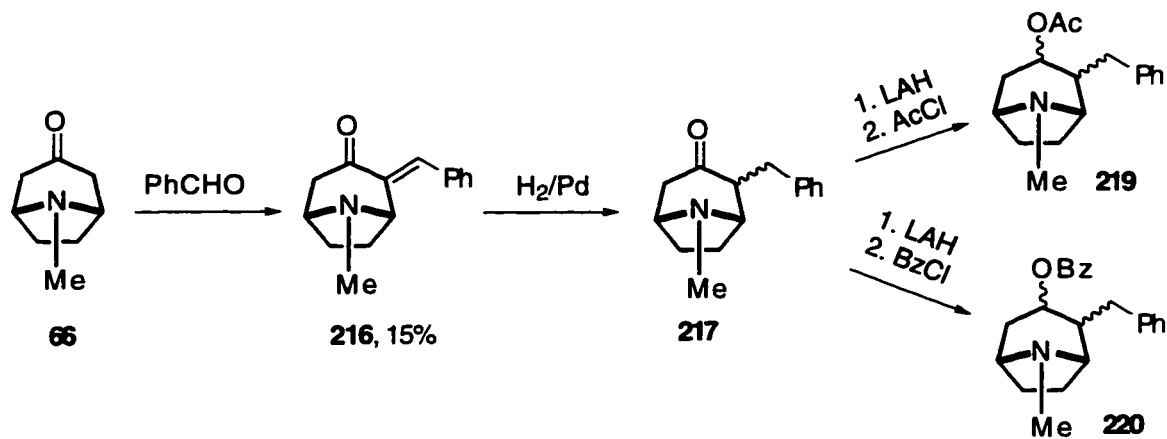

2.3. EPC synthesis of tropane alkaloids

The development of practical methods for the preparation of chiral compounds in an optically pure form is required for both pragmatic and academic purposes. The racemate, dextrorotatory, and levorotatory forms of a chiral compound are all chemically different entities. If a chiral product is to be used or exposed to a chiral environment (that includes all living organisms) the behavior of each of these entities will be different. Thus, the activity and toxicity of each of the three forms of a chiral substance, whether it is a drug, an agrochemical, a fragrance or a food additive, has to be studied. This often requires an EPC synthesis. EPC syntheses can also provide means of correlation of absolute configuration of optically active natural products. Knowledge of the absolute stereochemistry of a natural product does not only satisfy our scientific curiosity but might be helpful in the elucidation of the biosynthesis of the natural product.

The need for EPC synthesis of tropane alkaloids and their analogs is particularly urgent because most of the optically pure tropane alkaloids have never been available in quantities sufficient for a thorough study of their

biological properties. The following sections will present strategies and methods used in EPC synthesis based on resolution, chiral pool, and enantioselective reactions.

2.3.1. EPC synthesis based on resolution

Resolution of a racemic product was the earliest approach to synthesis of optically active compounds from optically inactive starting materials. This approach has perhaps only one advantage; it is general. Since half of the product is usually wasted, the resolution step should be carried out at as early stage of the synthesis as possible.

The optically active forms of cocaine were prepared by Willstätter, in 1923, *via* a total synthesis which included resolution (Scheme 44)¹¹⁵ and by Carroll in 1987 (Scheme 45).¹¹⁶ Both syntheses use similar reactions and follow the same strategy, however in the recent approach the resolution was used at an earlier stage. The difficulty of cocaine synthesis lies in the lack of method for diastereoselective reduction of methoxycarbonyltropinone (**240**) to give the ecgonine methyl ester (**248**). The best method so far, reduction with sodium amalgam under carefully controlled conditions, gives 3:2 selectivity in favor of the desired epimer **248**.^{116,117}

Other reports of synthesis leading to cocaine and its analogs differ from the previously described methods solely in the way of preparation of methoxycarbonyltropinone (**240**). For example, the Russian group¹²⁰ and Findlay¹¹⁸ used 2,5-diethoxytetrahydrofuran (**252**), prepared from furan by the Clauson-Kass method,¹³³ as a precursor for succindialdehyde (Scheme 46). Findlay's modifications included use of ketoglutaric anhydride (**253**) in the synthesis of optically active **240** (Scheme 47).¹¹⁹

Scheme 44

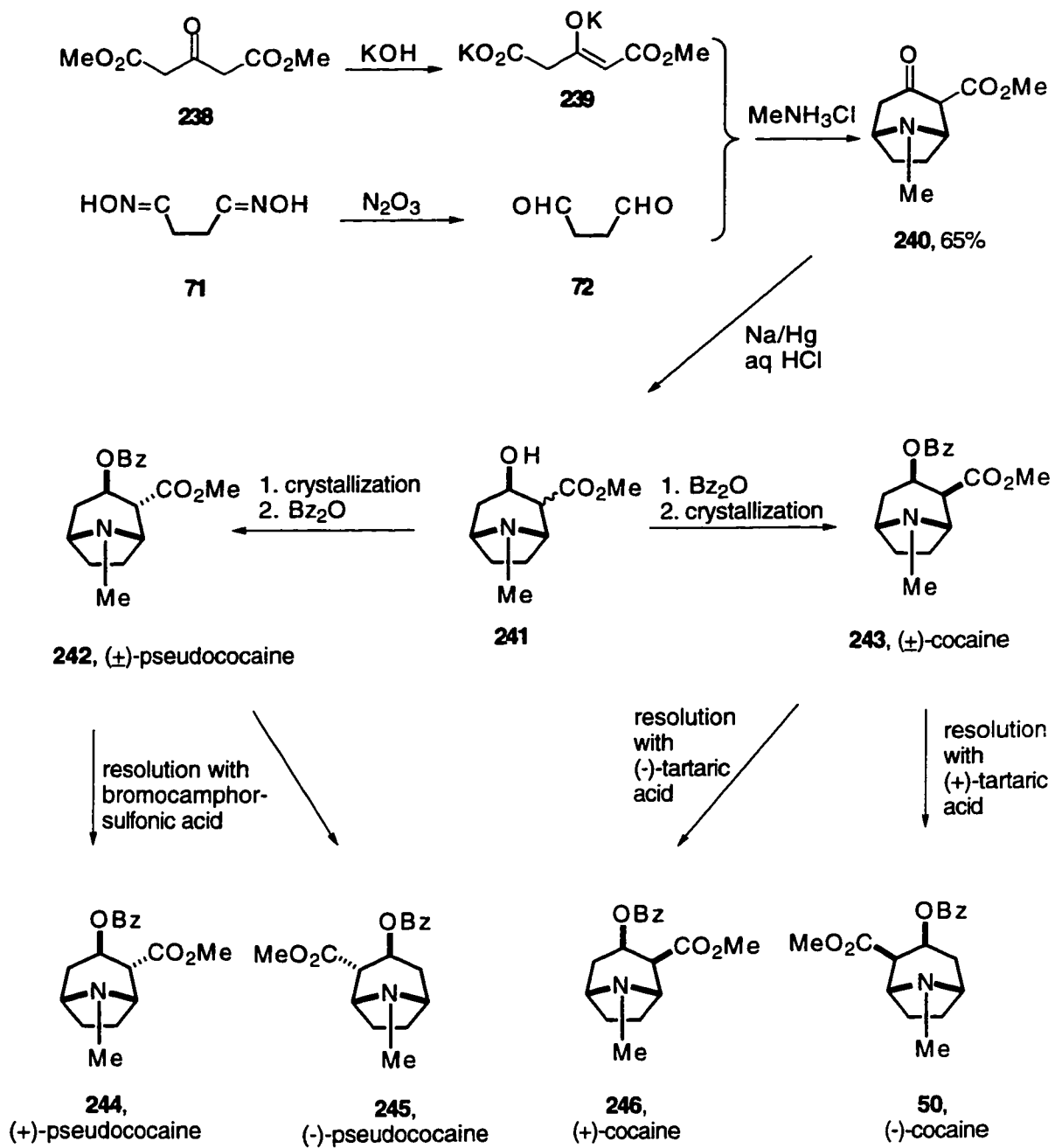

Scheme 45

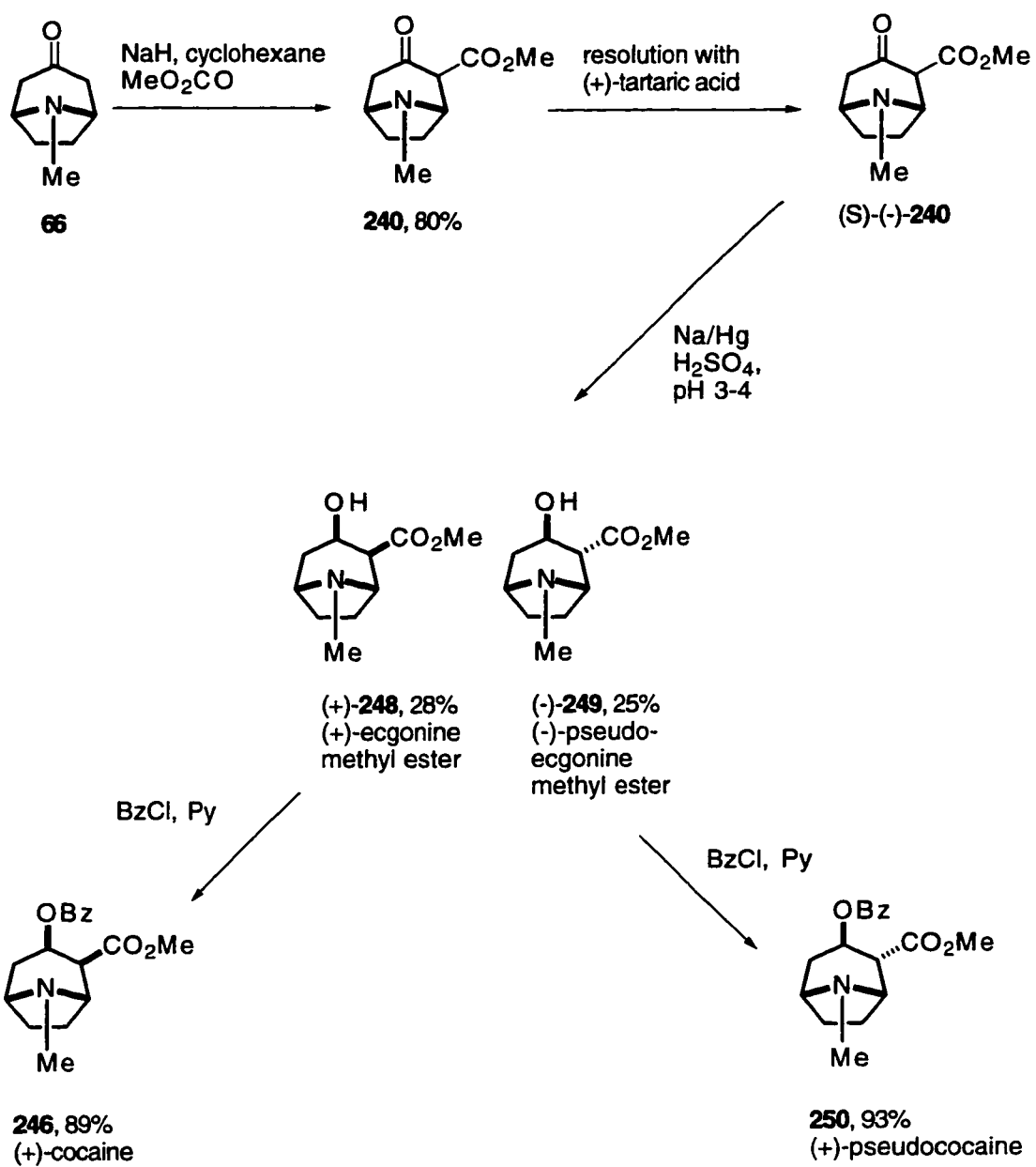

Scheme 46

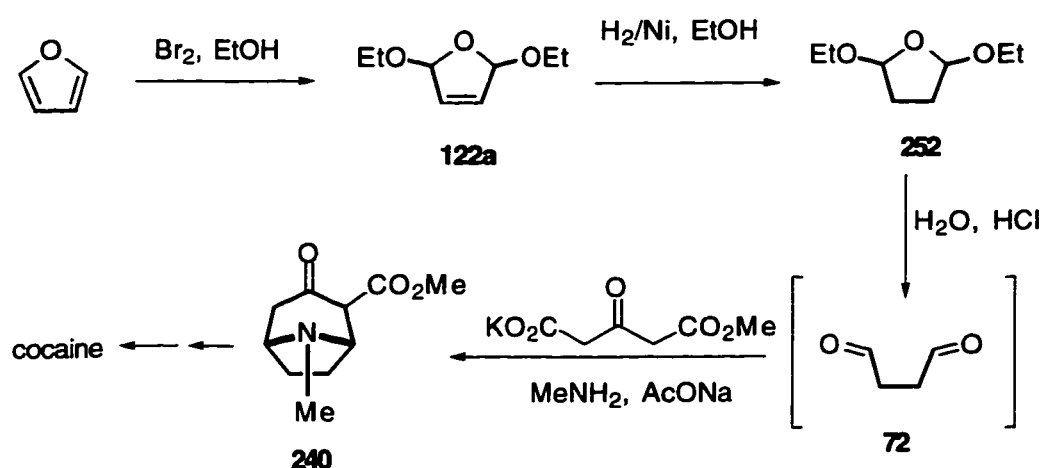

Scheme 47

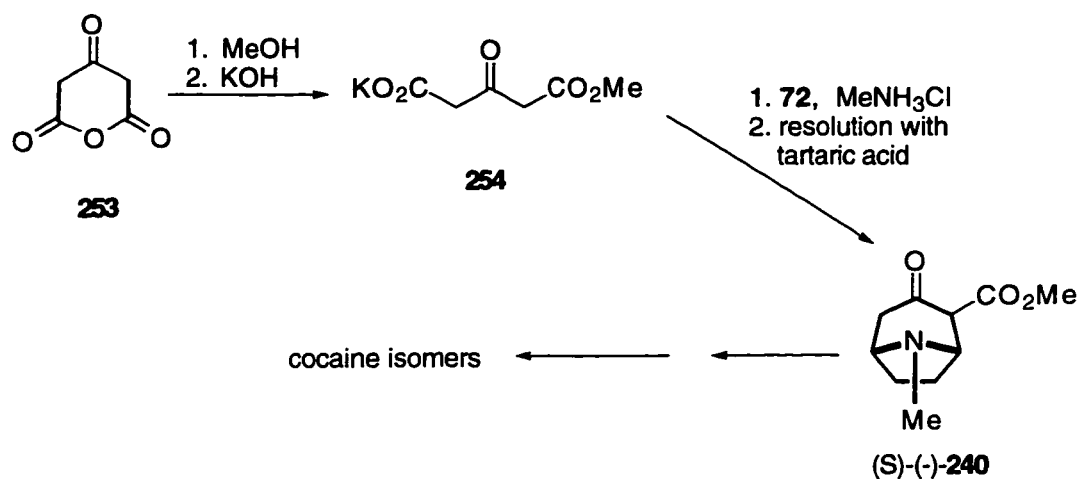

As described earlier (cf., section 2.2), 6 β -hydroxytropinone (**125**) was used as intermediate in the synthesis of racemic valeroidine. Thus, if resolved, the hydroxyketone **125** would provide access to enantiomerically pure 6 β -hydroxy tropane alkaloids. Examples of 6 β -functionalized tropanes, which were resolved with optically active acids, are given in Table 1.3. The resolution of racemic **125** with 3-bromocamphor-7-sulfonic acid was used by Stoll *et al.* in the synthesis of optically active valeroidine derivative (+)-**252**.¹²¹ Later,

Fodor *et al.* extended the synthesis to natural valeroidine by the controlled hydrolysis of diester (+)-**252** (Scheme 48).¹²²

Table 1.3. Examples of resolution of 6 β -functionalized tropanes.

Tropane derivative	Resolving agent	reference
6 β -hydroxytropanone 125	(+)-3-bromocamphor-7-sulfonic acid	121
6 β -hydroxytropanone 125	(1S)-(+)-10-camphor-7-sulfonic acid	123
3 α ,6 β -tropanediol 127	dibenzoyltartaric acid	124
6 β -phenylcarbamoyloxytropan-3 α -ol 127a	(+)-tartaric acid	125

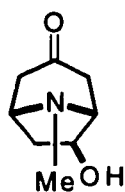
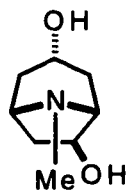
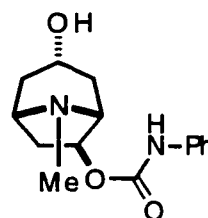
**125****127****127a**

Scheme 48

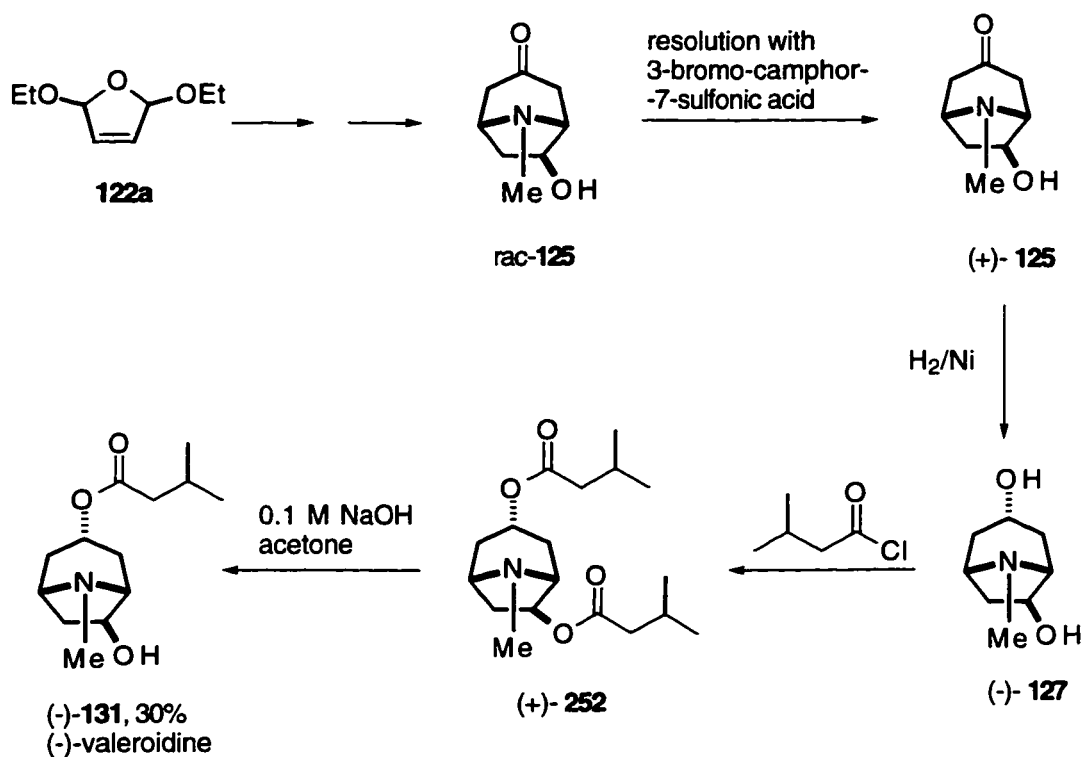

A total synthesis and resolution of the final alkaloid product was used by Pinder to prepare the natural enantiomer of (+)-physoperuvine (**260**).^{113,114a} This synthesis relied entirely on classical reactions (Scheme 49) and ultimately proved that the structure of physoperuvine was wrongly assigned in the past.¹¹⁴ The resolution was achieved by crystallization of di-*para*-toluoyl-(+)-tartaric acid salt and gave the dextrorotatory enantiomer in low yield.

Scheme 49

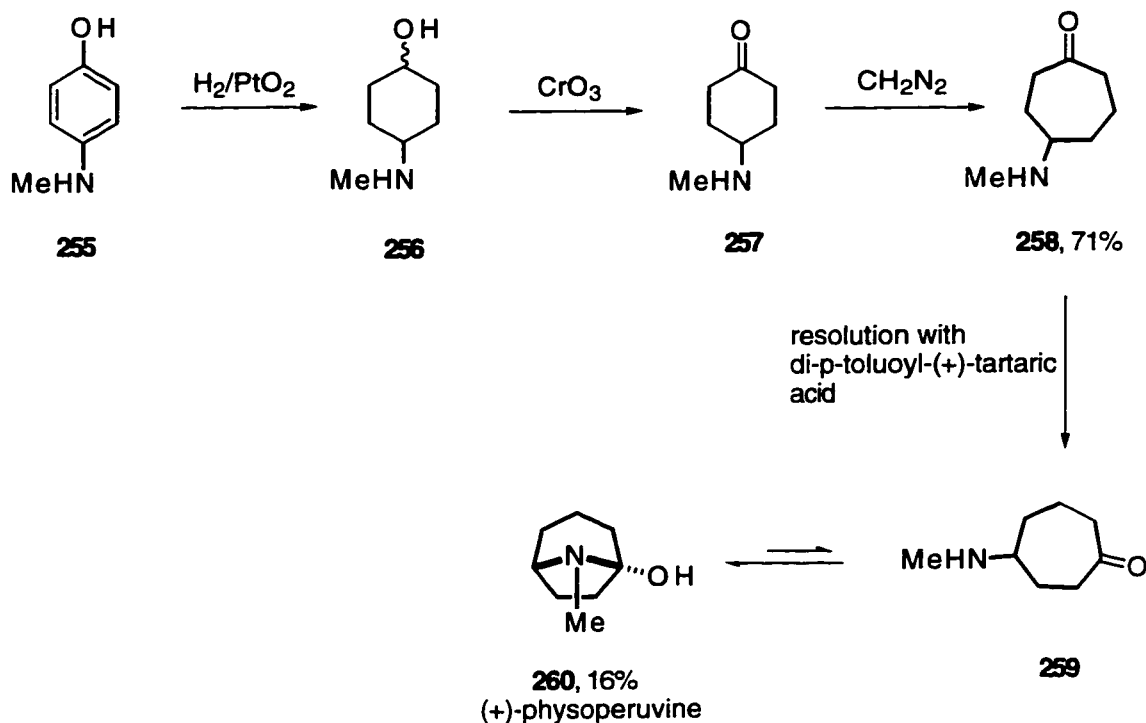

2.3.2. Synthesis from enantiomerically pure starting material

The so called "chiral pool approach" describes strategies which take advantage of readily available enantiomerically pure compounds (EPC's). Cocaine is a relatively cheap optically pure naturally occurring product. In principle, cocaine could be converted to other alkaloids with retention of the absolute configuration, thus providing a basis for EPC synthesis of tropane derivatives. The approach based on cocaine as a chiral building block would have, however serious practical constraints. Only a few alkaloids would be easily accessible by manipulation of cocaine derivatives and the targets would be limited to enantiomers of cocaine-like configuration. Not surprisingly the "chiral pool approach" was used almost exclusively in syntheses of cocaine isomers and its analogs.

Two syntheses starting from optically active anhydroecgonine ethyl ester were used by Bick *et al.* to confirm the structures and establish the absolute configurations of ferrugine and ferruginine (Scheme 50).⁹⁹ These syntheses resulted in unnatural forms of the alkaloids i.e. (-)-*ent*-ferrugine (**265**) and (-)-*ent*-ferruginine (**267**). Diastereoselectivity of the hydrogenation of anhydroecgonine ethyl ester was low under atmospheric pressure but improved at 8 psi, giving only one product **262**.

Scheme 50

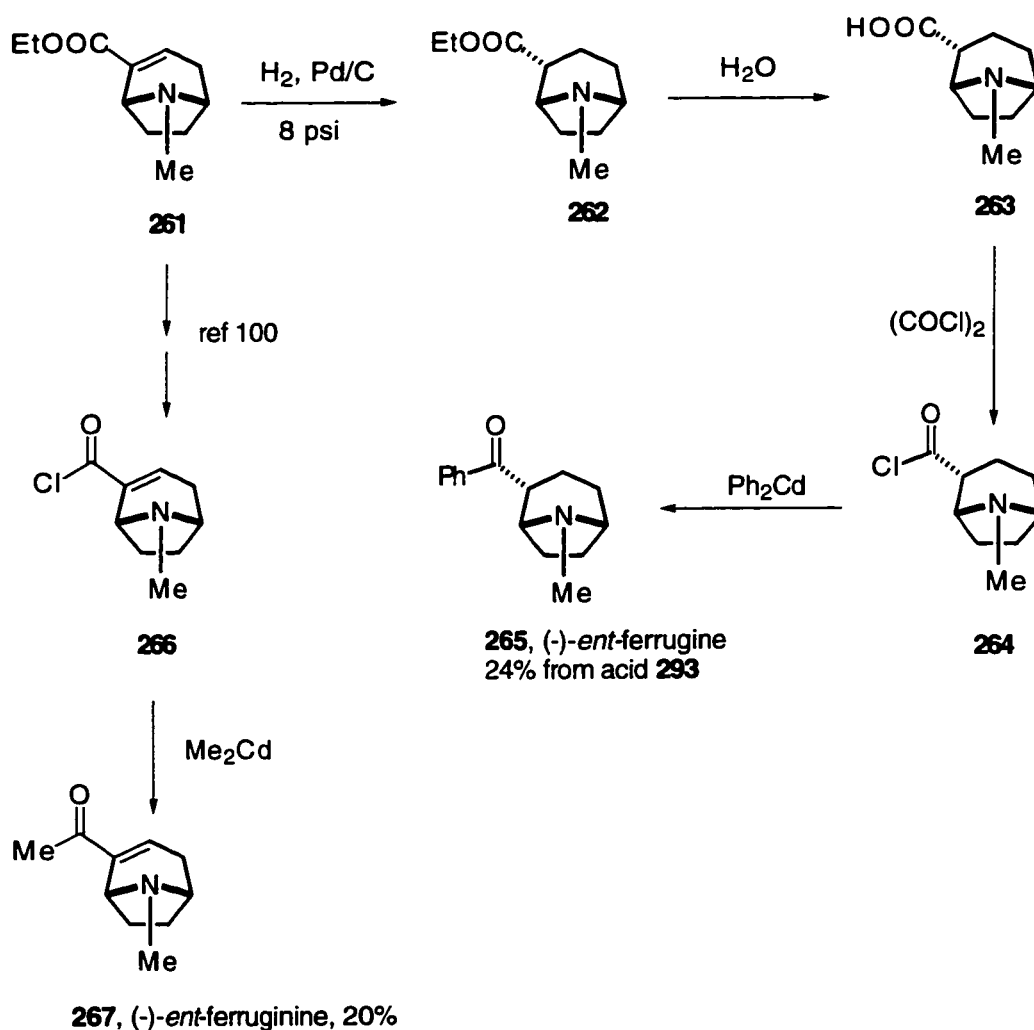

The natural (–)-cocaine (**50**) was the starting material used by Carroll *et al.* for the preparation of the cocaine epimer known as pseudococaine **268** (Scheme 51).¹⁰¹ Isomerization was done under basic conditions with concomitant hydrolysis of the benzoyl group. The pseudoecgonine methyl ester was then benzoylated under standard conditions to give **268**. Yields were not reported.¹⁰¹

Scheme 51

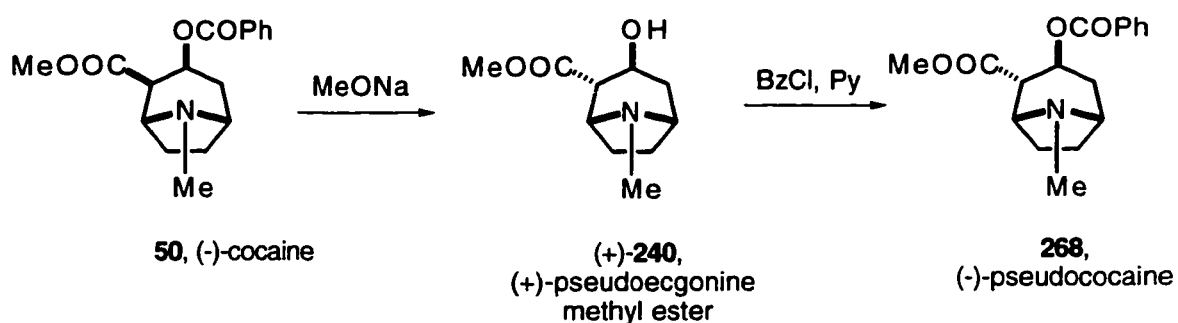

A series of cocaine analogs of general structure **273** was prepared for studies of their affinity to cocaine binding sites of the mammalian brain.⁹⁶⁻⁹⁸ A specific example of the synthesis leading to one of the 3 β -aryl-2 α -methoxycarbonyltropane is given in Scheme 52. The natural (–)-cocaine was converted to the methyl ester of anhydroecgonine (**270**) through acid hydrolysis, dehydration and esterification. The conjugate addition of 4-fluorophenyl magnesium bromide to anhydroecgonine methyl ester (**270**) exhibited modest diastereoselectivity. The major product **271** had to be purified by chromatography and crystallization from THF.

Scheme 52

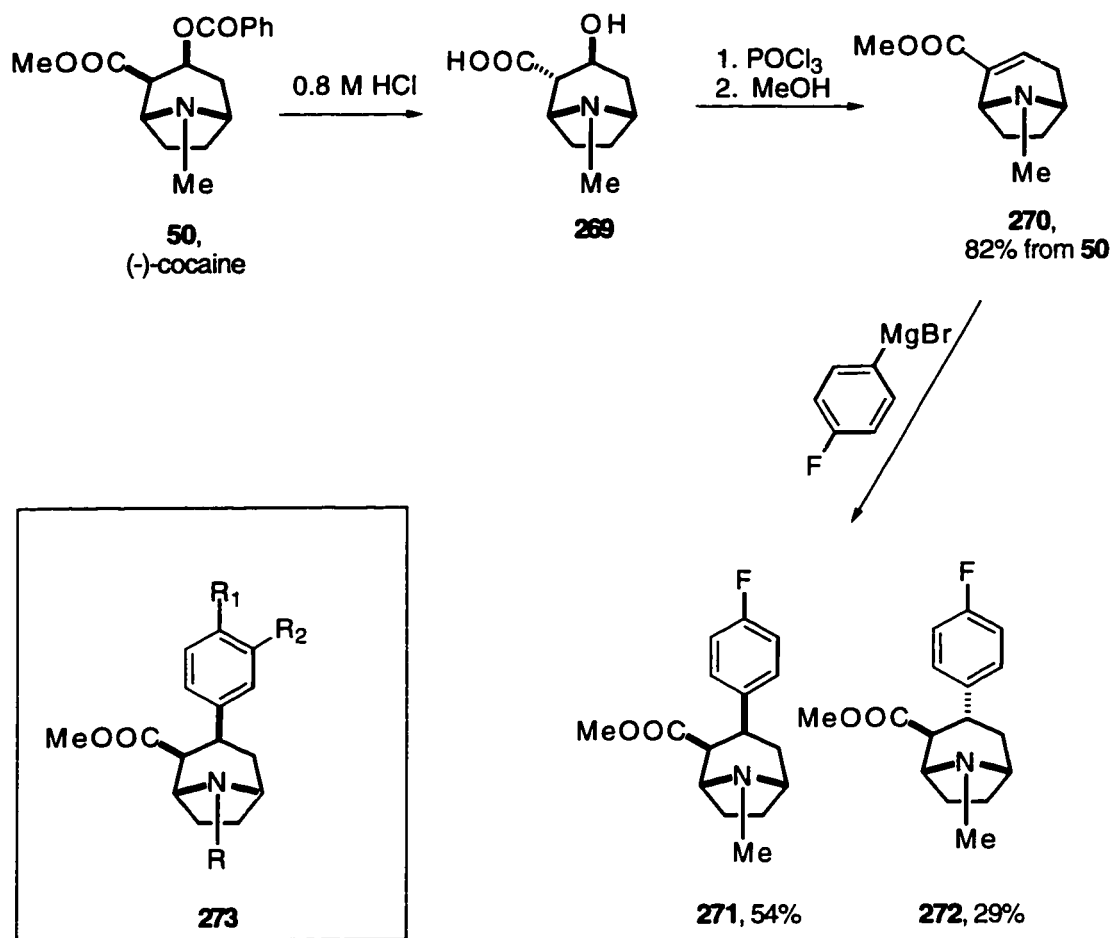

Enantiomerically pure calystegine B₂ was the target of synthesis by two French groups. Duclos *et al.* prepared both enantiomers of calystegine B₂ via the same cycloheptano-isoxazoline intermediate **281** which was obtained from methyl α -D-glucopyranoside (Scheme 53).^{105,106} The isoxazoline **281** was formed in the intramolecular cycloaddition of the olefinic nitrile oxide **279**.

Scheme 53

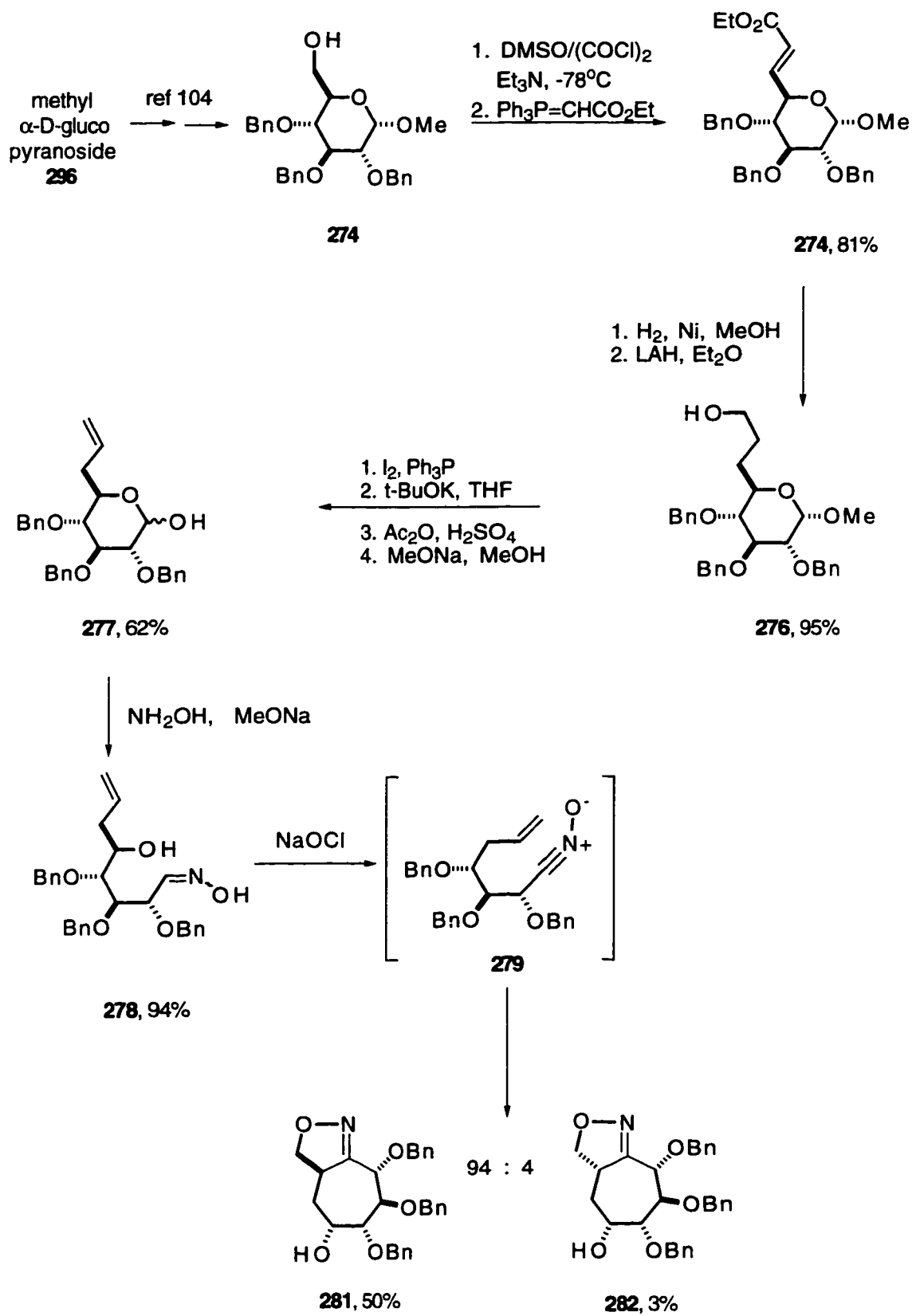

The stereochemistry of the bicyclic products **281** and **282** was assigned on the basis of proton NMR and NOE difference experiments. As shown in Scheme 54, the hydroxymethyl group in **284** was removed by Swern oxidation followed by *in situ* deformylation through a retro-Claisen reaction. The reduction of ketone **286** with DIBAL-H was 95% diastereoselective and gave the desired isomer **287**, as proven by MOM ether deprotection of **287a** to a meso-diol. It was possible to prepare both enantiomers of **288** by taking advantage of the pseudosymmetry of **287**. The reactions depicted in Scheme 55 were used to achieve that goal. Both the zinc azide-mediated Mitsunobu reaction and the tosylate substitution with sodium azide took place, as expected, with inversion of configuration. Further manipulations led to calystegine B₂ (**290a**) and its optical antipode **290b**.

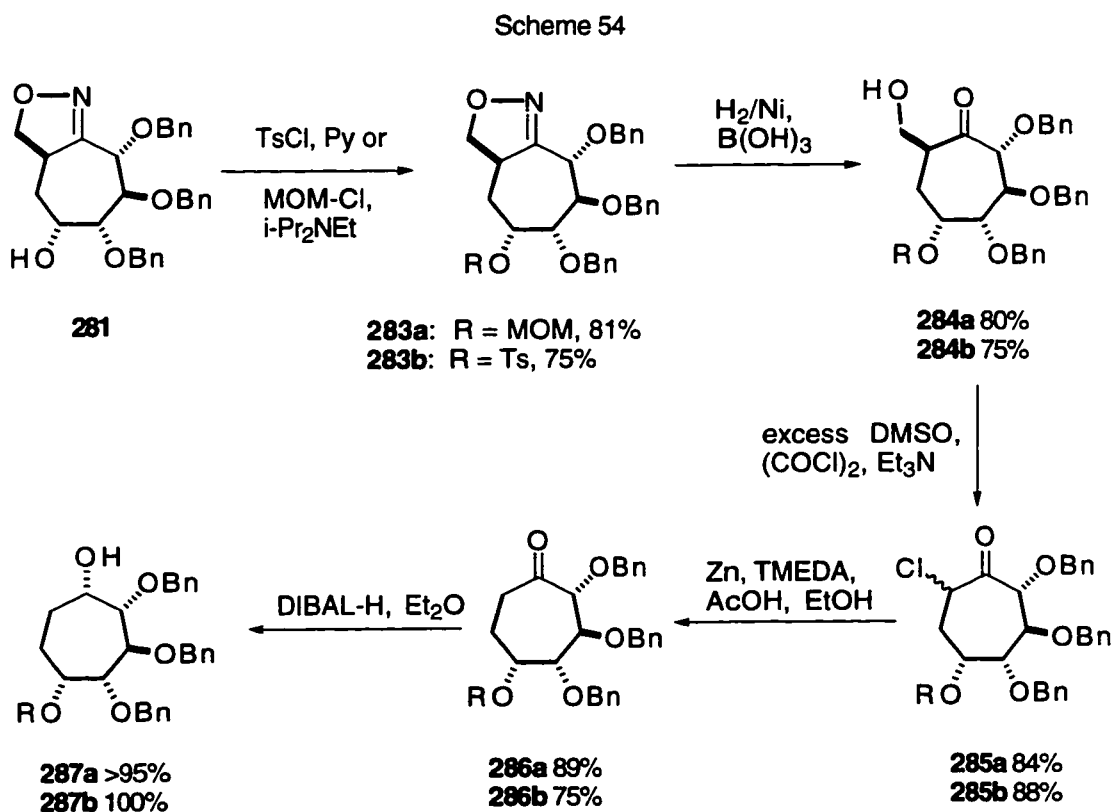

Scheme 55

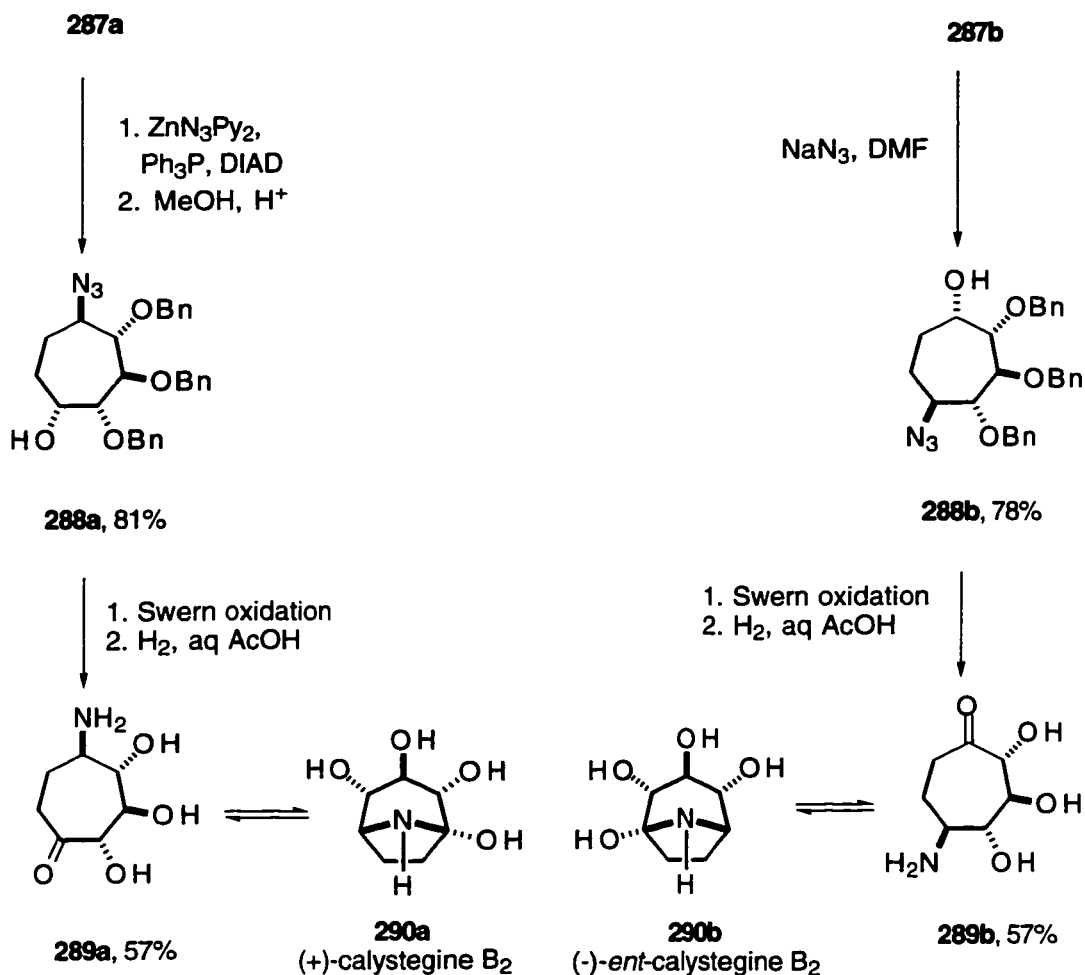

Boyer and Lallemand used a ring enlargement of the polysubstituted cyclohexanone **300** and introduction of masked amino group in a form of azide to synthesize (-)-calystegine B₂ (**290b**, Scheme 57).¹⁰⁸ The key chiral intermediate **300** was prepared from methyl α -D-glucopyranoside **296** through standard carbohydrate chemistry and Ferrier reaction (Scheme 56).¹⁰⁷ The Ferrier reaction gave 8:2 mixture of polysubstituted

cyclohexanones **299a** and **299b**. The mixture was separated by flash chromatography and the major isomer was transformed to **300** through silylation (Scheme 56). The regioselective enlargement of the 6-membered ring of ketone **300** was achieved by addition of carbenoid (CH_2I_2 and Et_2Zn) to C=C bond of the silyl enol ether **301** followed by opening of the cyclopropane ring with ferrous chloride (Scheme 57). Reduction of ketone **305** was not stereoselective and resulted in the 1:1 mixture of diastereoisomers, which were separated by chromatography. The rest of the synthesis followed standard pathways.

Scheme 56

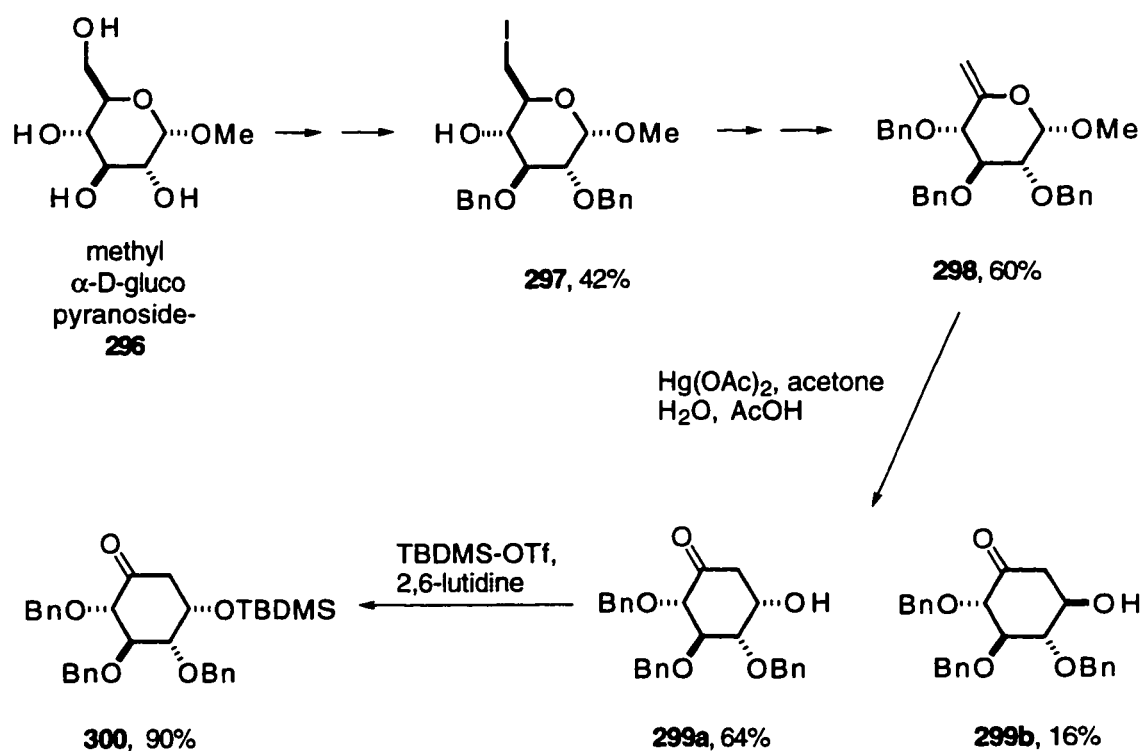

Scheme 57

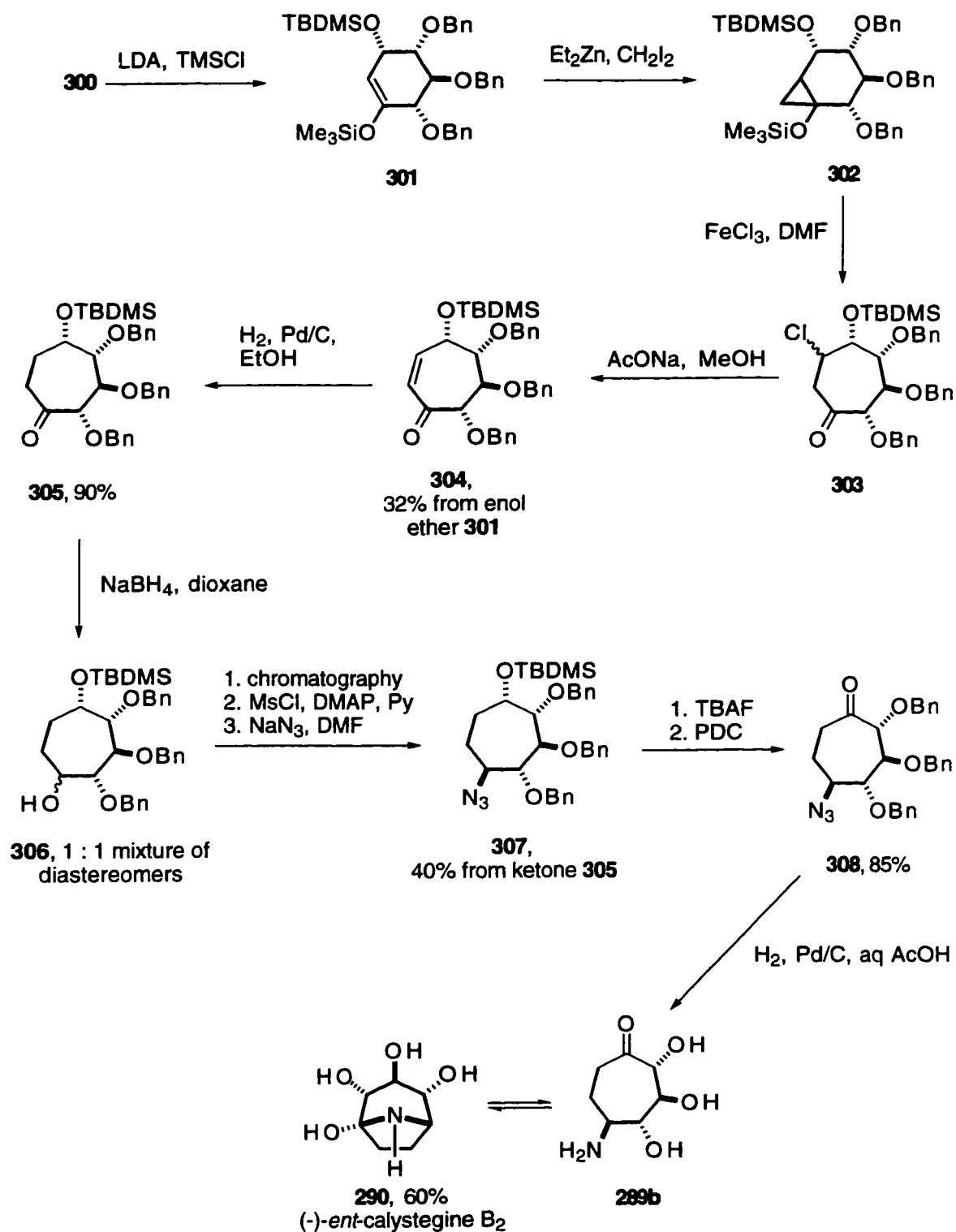

The natural enantiomer of baogongteng A (**52**) was synthesized, recently, *via* diastereoselective 1,3 dipolar cycloaddition (Scheme 58) by Pham and Charlton.¹³⁷ The strategy is analogous to previously described Jung's synthesis of racemic baogongteng A (Scheme 27).

Scheme 58

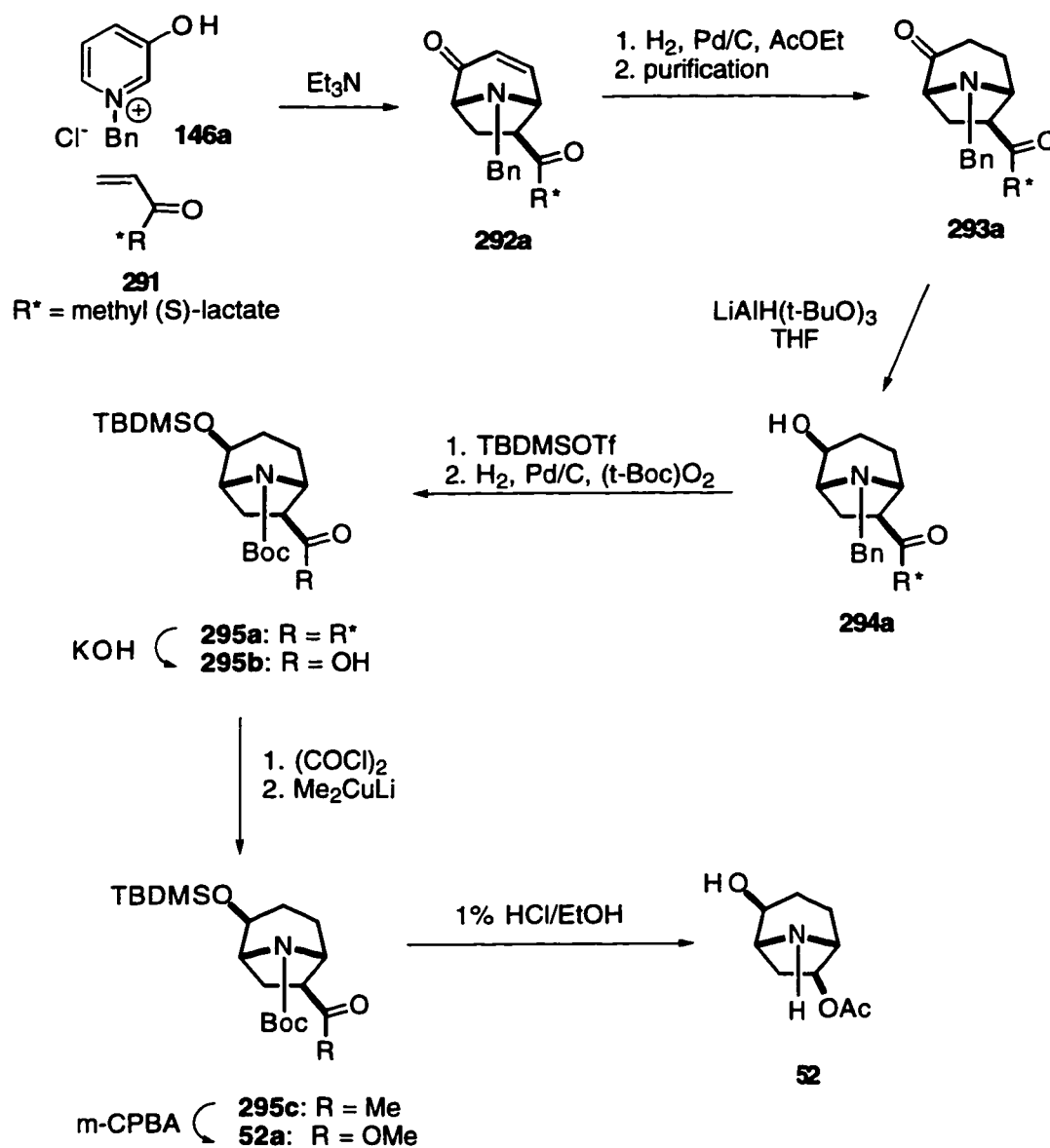

The reaction of the acrylate of methyl (*S*)-lactate with **146a** gave a mixture of products in which **292** constituted 65%. The reaction worked best in AcOEt solution at rt and required 10 days. Hydrogenation of the mixture of products followed by separation (chromatography and crystallization) gave the ketone **293** which was reduced with LiAlH(*t*-BuO)₃. The reduction achieved modest stereoselectivity (ca. 3:1) and provided the desired *exo* alcohol **294**. Sodium borohydride gave, under the same reaction conditions, the *endo* alcohol as the major product. The *exo* OH group had to be protected, as the TBDMS ether, before the protecting group on nitrogen was exchanged and the lactate ester hydrolyzed. The acid **295b** was converted *via* the acid chloride to the ketone **295c** which was subsequently subjected to a Baeyer-Villiger oxidation. The Baeyer-Villiger rearrangement gave the protected baogongteng A (**52a**). The deprotection of the *t*-Boc and TBDMS groups, under acidic conditions, completed the synthesis of (–)-baogongteng A.

2.3.3. Enantioselective synthesis

Enantioselective synthesis is a type of EPC synthesis which takes advantage of an enantioselective reaction i.e. a reaction which gives chiral, enantiomerically enriched products from an achiral substrate. To the best of my knowledge there is only one report of the synthesis of optically pure tropane alkaloids based on enantioselective reactions. This is a very recent synthesis of the hydrochlorides of both enantiomers of calystegine A₃ described by Johnson and Bis in 1995.¹⁰⁹ Their approach was based on enzymatic desymmetrization of meso-diols and meso-diacetates (Scheme 59).

Scheme 59

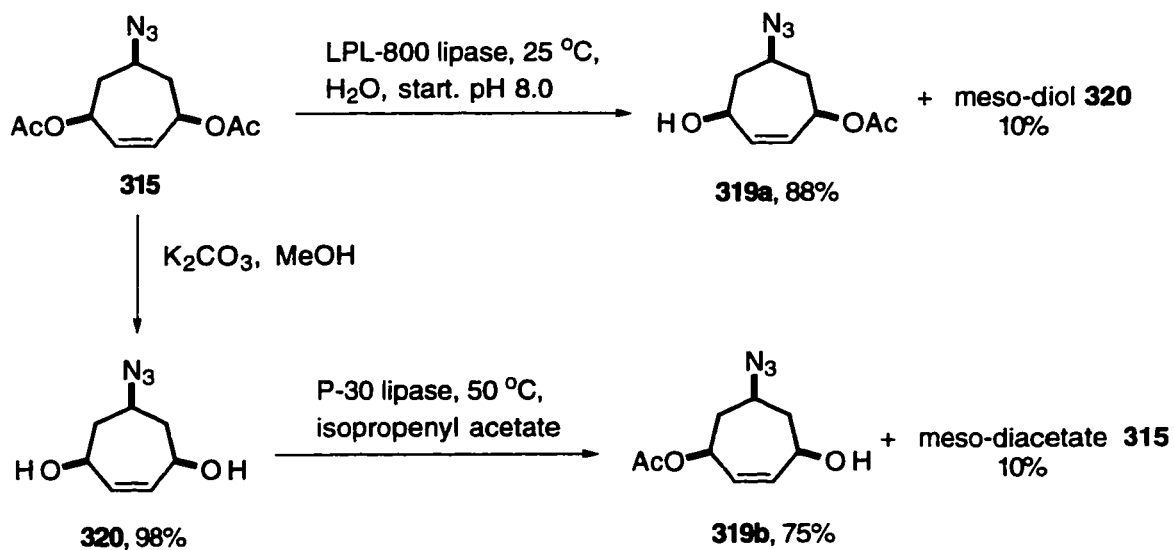

The two acetate groups in **315** and the OH groups in **320** are enantiotopic. When one of the enantiotopic OH groups of the meso-diol (achiral) **320** was selectively acetylated the symmetry of the starting molecule was removed which resulted in the chiral product **319b**. Such selective acetylation of cyclic diols could be accomplished with the help of the enzyme known as Amano P-30 lipase (a lipase from *Pseudomonas cepacia*) and the acetylating agent isopropenyl acetate. By the same token, selective hydrolysis, with *Pseudomonas cepacia* lipase LPL-800, of one of the enantiotopic acetate groups of the meso-diacetate **315** could lead to the chiral monoacetate **319a**.

Scheme 60

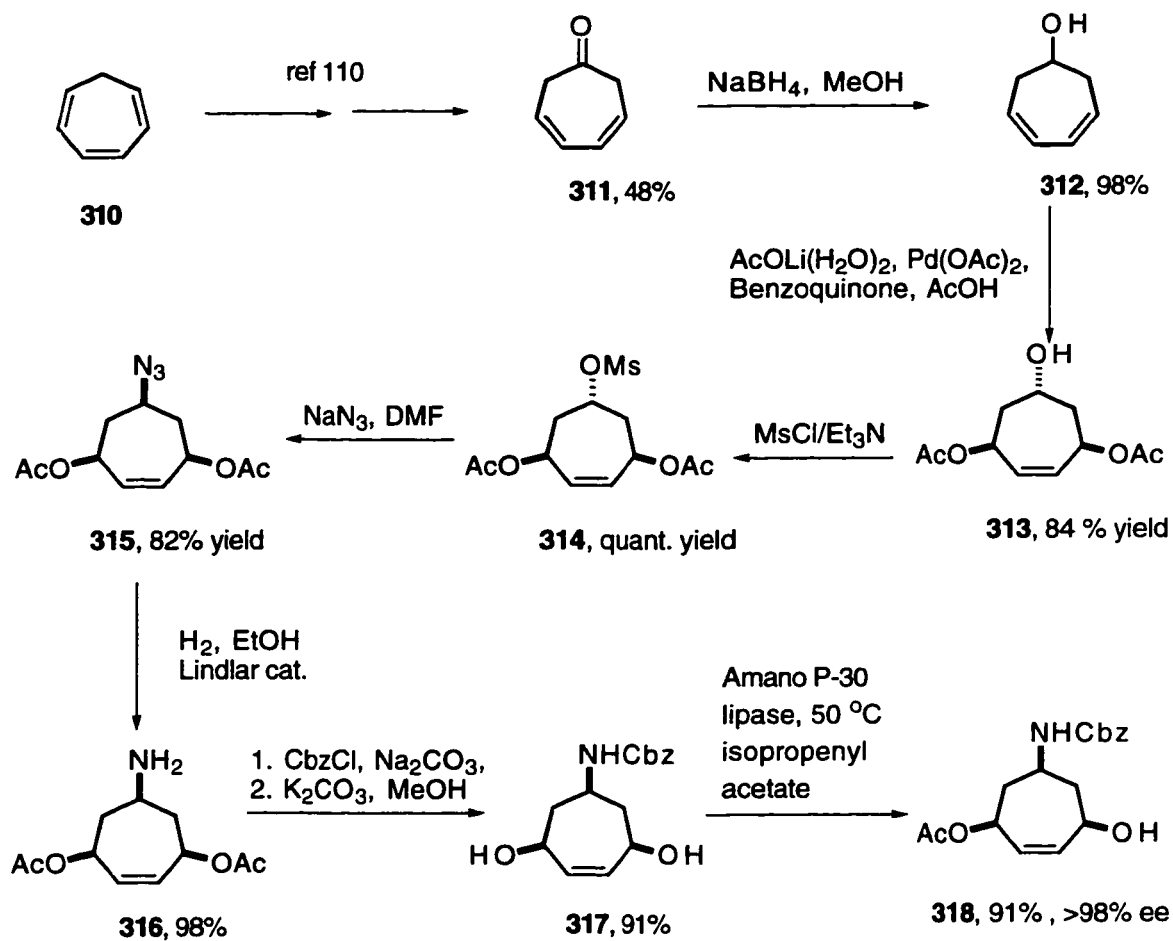

As indicated by the substantial amount of the meso byproducts (Scheme 59) the enzymes did not show very high selectivity. This observation was rationalized by a lack of the sufficient spatial requirements of the long and flat azide group. In order to alleviate this problem the azide group was transformed into more sterically demanding benzyl carbamate group (Scheme 60). Enzymatic acetylation of 317 and its t-Boc analog was highly enantioselective

Scheme 61

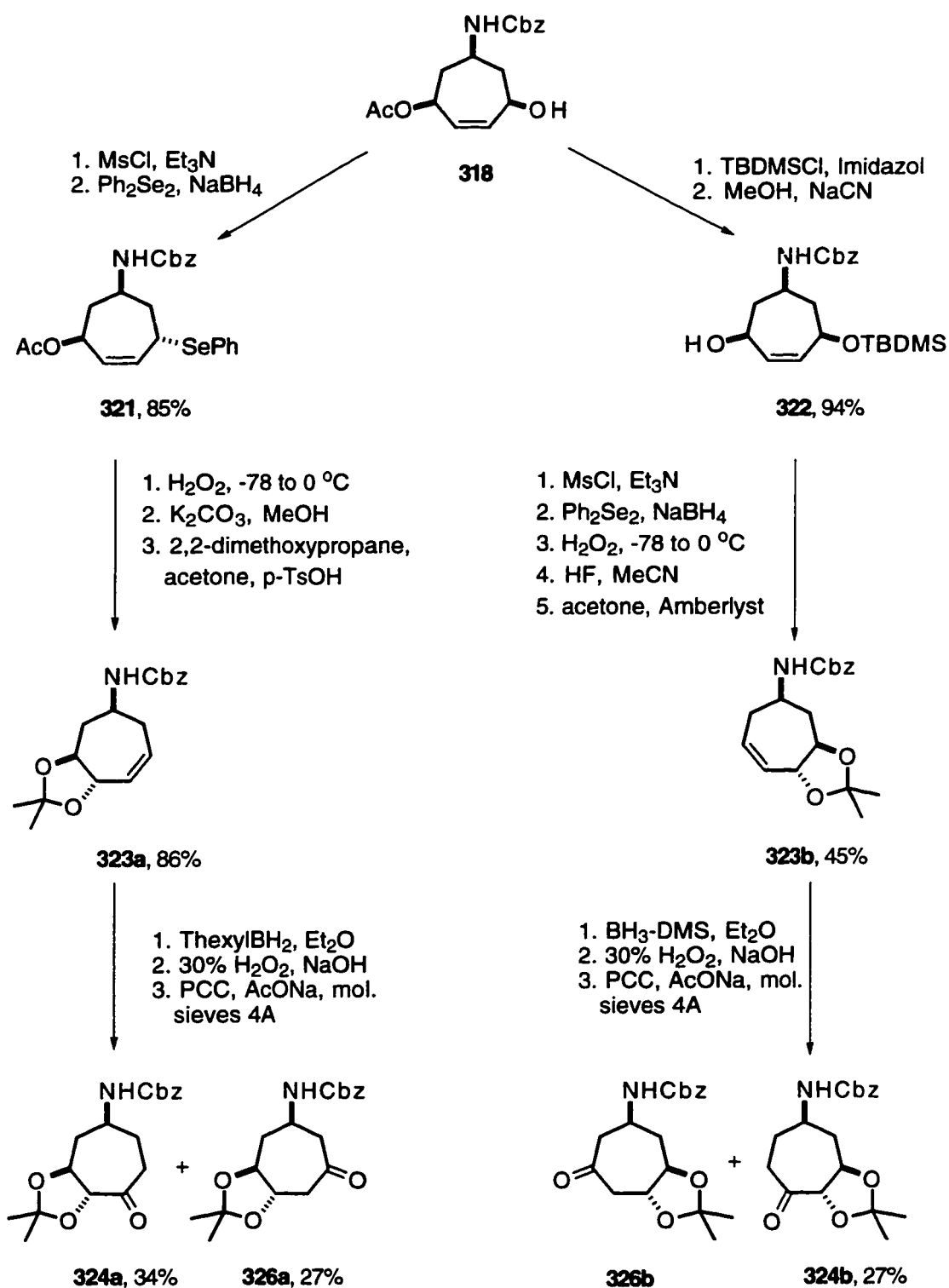

giving the monoacetate **318** in excellent yield and higher than 98% ee (as determined by the Mosher's ester method¹¹¹). The absolute stereochemistry of the product **318**, as shown in Scheme 60, was determined on the basis of CD measurements and an empirical model for *Pseudomonas cepacia* lipase catalyzed reactions.¹¹²

The scalemic monoacetate **318** was used to prepare both optical antipodes of the ketone **324** (Scheme 61). Those transformations relied on oxidation of the allylic selenide **321** to the selenoxide followed by a rearrangement to the allylic selenenate, which readily underwent hydrolysis. This rearrangement was sigmatropic and ensured the *syn* position of the selenenate group and selenoxide group in the transition state which secured the *trans* configuration of the oxygen atoms in **323**. Due to the poor regioselectivity of the hydroboration of **323**, the ketones **324a** and **324b** were

Scheme 62

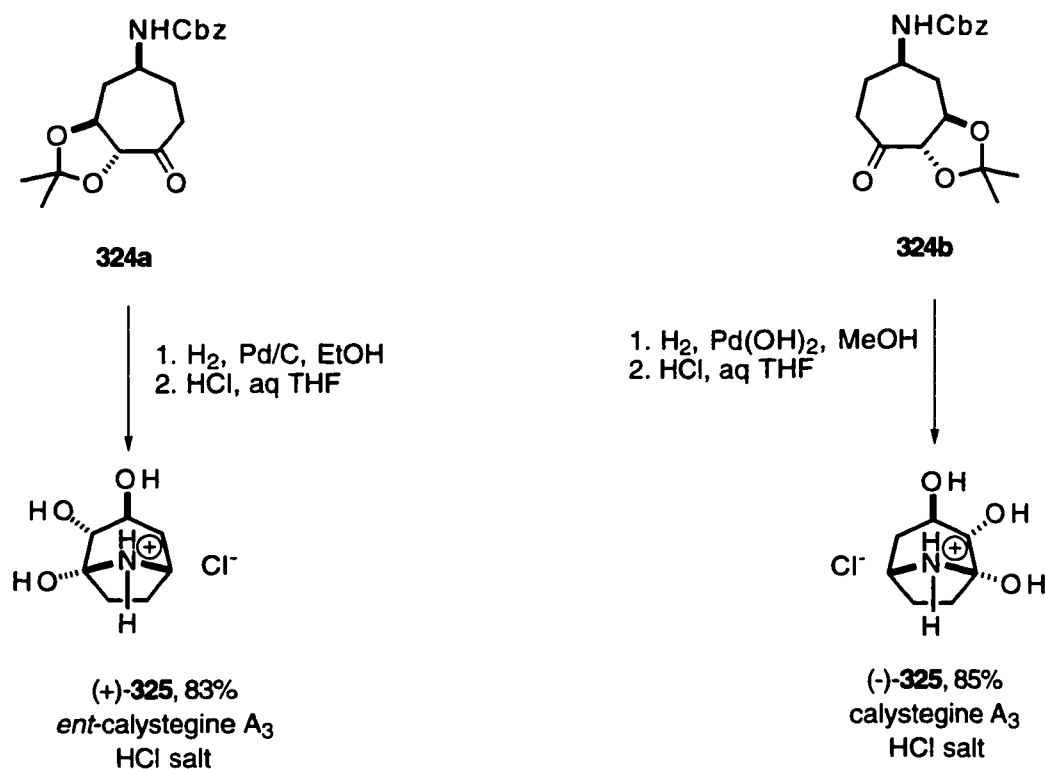

obtained in modest yield and had to be separated from their regioisomers **326a** and **326b** respectively. Deprotection of the amine group in **324** by hydrogenolysis and deprotection of the diol by hydrolysis gave calystegine A₃ (Scheme 62). The order of the deprotection steps was important since the α,β -dihydroxy ketone was not stable to the acidic conditions of acetal hydrolysis. However, when the amine group was deprotected first, the carbonyl group of the α,β -dihydroxy ketone formed an intramolecular hemiaminal, thus decreasing the decomposition of the α,β -dihydroxy ketone. Although the calystegine A₃ hydrochloride (–)-**325** and its *ent*-form (+)-**325** were prepared in 60 mg and 80 mg quantities respectively the free bases could not be obtained because of decomposition. The Johnson synthesis constitutes the only example of EPC synthesis of a tropane alkaloid *via* an enantioselective reaction.

2.4. Conclusions

Tropane alkaloids have been synthetic targets for almost 100 years. Most of the work devoted to syntheses of these alkaloids was concentrated on the construction of the tropane skeleton (e.g. Robinson-Schöpf synthesis and its modifications or Katritzky's 1,3-dipolar cycloaddition). Methods for diastereoselective reduction of tropinone are available. As a result, simple tropane derivatives e.g., tropinone and tropine are inexpensive, readily available compounds. Despite that, the stereoselective preparation of seemingly easily obtainable tropane derivatives might be quite challenging and might require a multistep synthesis. Tufariello's synthesis of (\pm)-cocaine (Scheme 28) and Bäckvall's synthesis of scopine and pseudoscopine

(Scheme 20) illustrate this point. The Tufariello's route to racemic cocaine could be used for the synthesis of enantiomerically pure cocaine by the introduction of a chiral auxiliary in one of the substrates of the 1,3-cycloaddition reaction (cf., Scheme 28). That could be a more efficient method for the synthesis of unnatural (+)-cocaine than the approaches based on resolution and reduction of methoxycarbonyltropinone. This is especially important since a method for the reduction of methoxycarbonyltropinone with high *exo*-diastereoselectivity giving cocaine like relative configuration is still unavailable (cf. Scheme 45).

There are only a few syntheses of tropane alkaloids based on functionalization of tropinone or other readily available precursor containing tropane skeleton. They include Lounasmaa's and Bick's approaches to pyranotropanes, knightinol, alkaloid KD-A and alkaloid KD-B. Issues of stereoselectivity have not been addressed in these works. A few enantiomerically pure alkaloids (e.g. calystegines A₃ and B₂, baogongteng A) were prepared from the available optically pure starting materials. However the diastereoselectivity of many of the reactions involved in these synthesis was poor or modest (cf., Schemes 27, 52, 57, 58). Despite the fact that practical methods for the preparation of several optically pure alkaloids have been described, no general strategies applicable to diverse types of tropane alkaloids have been elaborated to date. It is remarkable that the only enantioselective synthesis (i.e., the EPC synthesis based on an enantioselective reaction) of a tropane alkaloid, calystegine A₃, was published recently (1995).

The literature review shows that there is a need for development of a general approach to enantioselective synthesis of tropane alkaloids.

CHAPTER II : RESULTS AND DISCUSSION

1. Introduction

Tropinone enolate as a reagent for tropane synthon: Formidable entry into EPC synthesis of tropane alkaloids

The tropane alkaloids family can be divided into several subgroups of structurally related compounds. The specific examples of members of each of

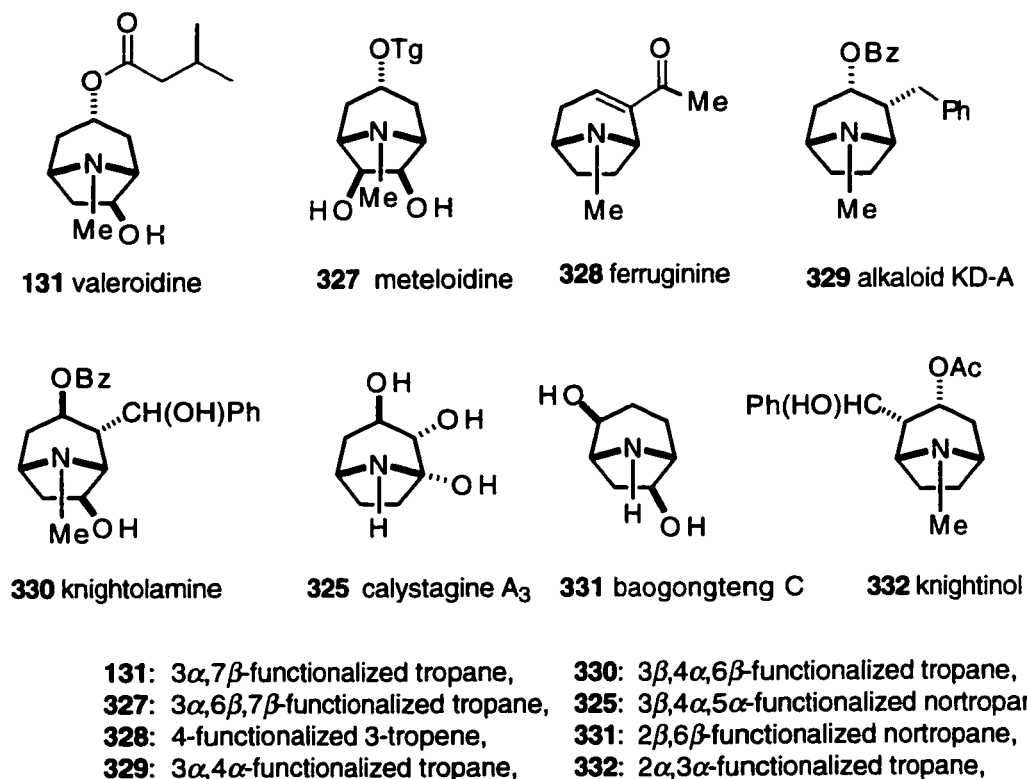
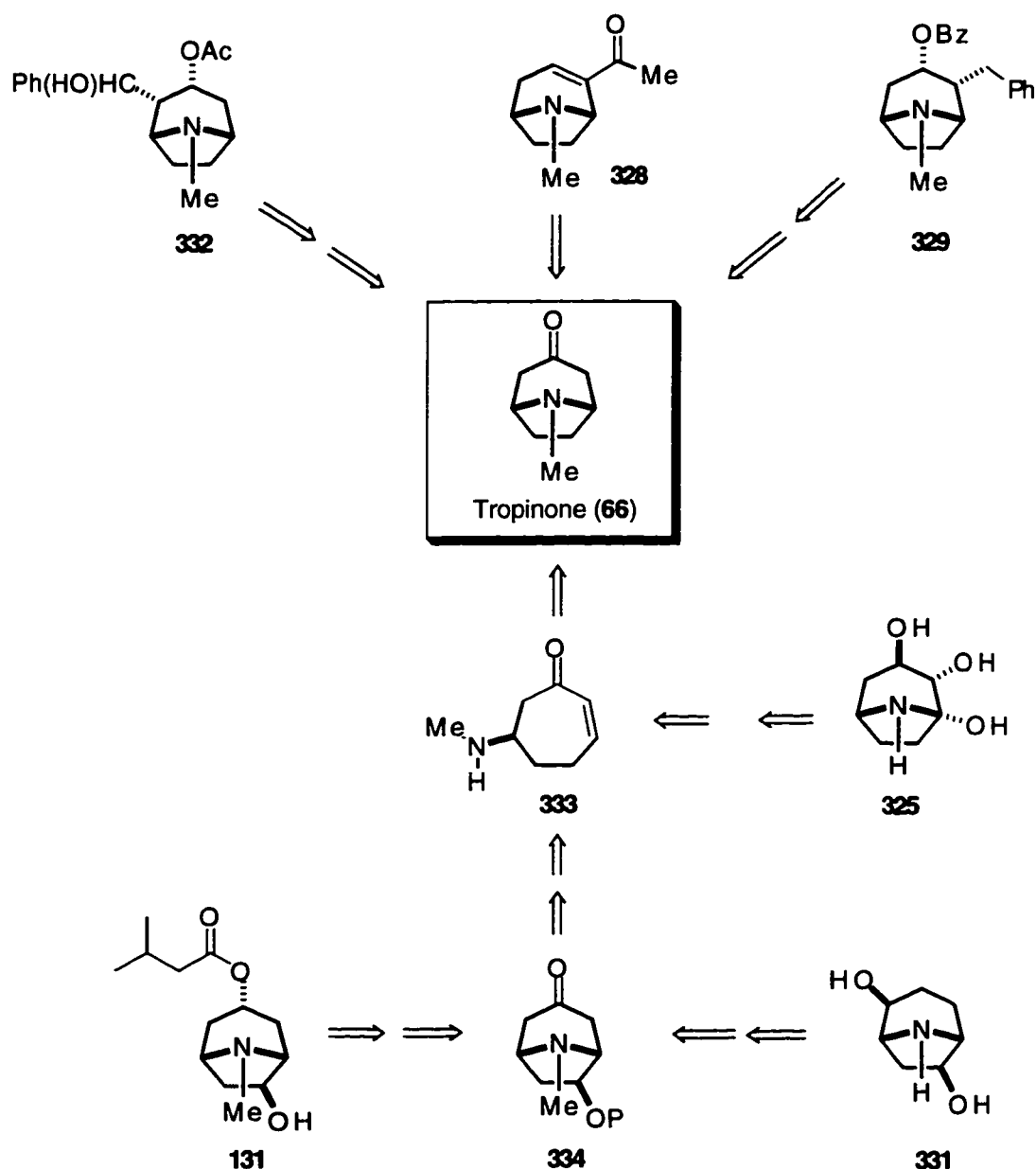

Fig. 2.1. Representative examples for each of the different groups of tropane alkaloids

the subgroups (except for the trivial case of 3-substituted tropanes) are shown in Figure 2.1. A good synthetic strategy towards the synthesis of tropane alkaloids should be as general as possible i.e., it should provide access to as many of such groups of related products as possible. The desirable feature of such synthetic strategy would be the potential for obtaining the racemate and

Scheme 63



either enantiomer of the target compound *via* the same route. As shown by the retrosynthetic analysis of representative tropane alkaloid targets, tropinone can be seen as the common precursor of all types of tropane alkaloids (Scheme 63).

Scheme 64

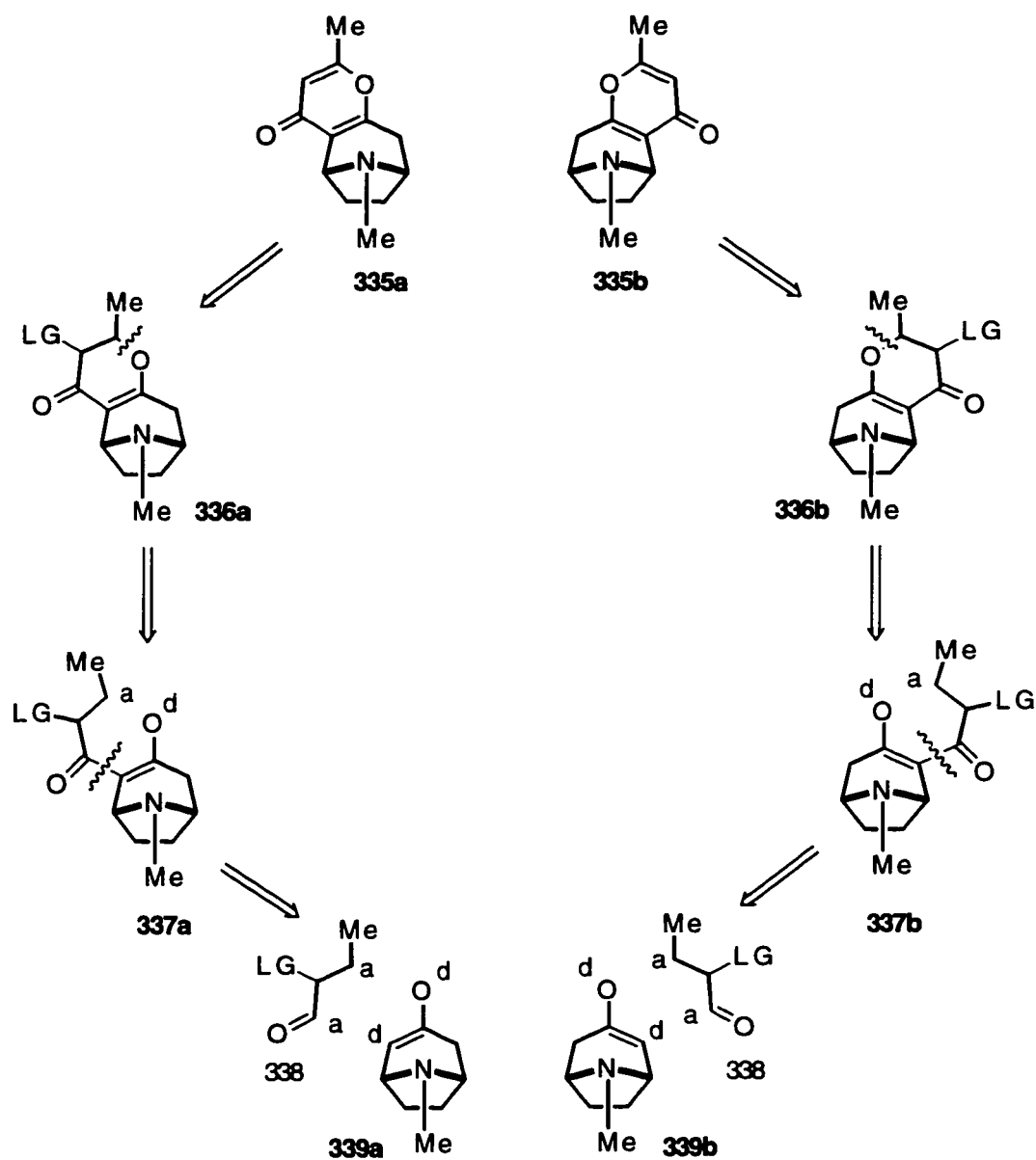

A detailed retrosynthetic analysis of both enantiomers of isobellendine (**335**) is presented in Scheme 64. The analysis shows that the synthesis of both optical antipodes of the alkaloid can be envisaged from synthon **339**. Since tropinone lithium enolate (**40**) can serve as a reagent for the chiral tropane synthon **339**, the enantioselective formation of that enolate from tropinone could provide an entry to a general EPC synthesis of various members of tropane alkaloids. The viability of such approach depends on the availability of the tropinone lithium enolate reagent in enantiomerically pure form. The methodological studies towards elaboration of methods for generation of lithium tropinone enolate in synthetically useful enantiopurity will be the subject of the next section.

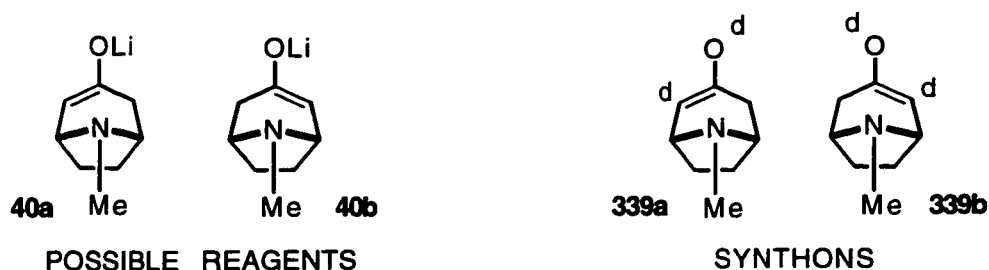

2. Methodological studies

The C-H group in the α -position to the carbonyl group of a ketone is more acidic (typically pK_a 19-20) than a C-H group of an alkane and as a consequence can be removed by a base. The tropinone enolate is formed in the reaction of tropinone (**66**) with a strong base. Lithium amides (e.g., LDA, LiHMDS) are sufficiently strong bases, and are often used for deprotonation of ketones.^{4b} Although tropinone has two pairs of diastereotopic hydrogens (each pair consisting of the axial and the equatorial H) α to the ketone group,

abstraction of either one of the two diastereotopic protons results in formation of the same enolate **40**. Although the diastereoselectivity of deprotonation of tropinone was not determined experimentally, one can presume, that on the basis of steric hindrance associated with the bicyclic structure, the axial hydrogens should be attacked preferentially by the approaching base. The preference for the abstraction of the axial hydrogens over the equatorial hydrogens was first observed in steroidal system by Corey.^{37a} The observation was rationalized not by steric argument but on the basis of the π - σ^* orbital interactions (stereoelectronic argument^{37b}). It was suggested that the interaction of the π orbital of the C=O bond with the antibonding σ^* orbital of the axial C-H bond destabilizes the C-H bond. Similar interaction was not possible for the equatorial C-H bond because of the different relative spatial arrangement of the corresponding π and σ^* orbitals (Figure 2.2).

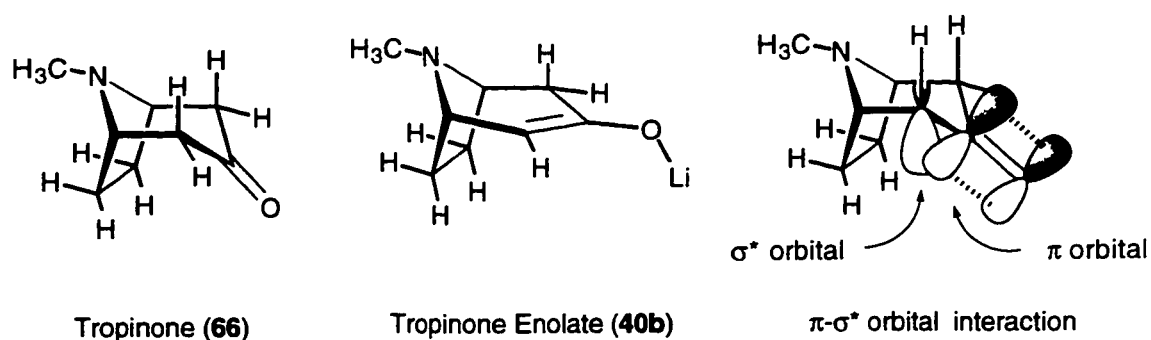
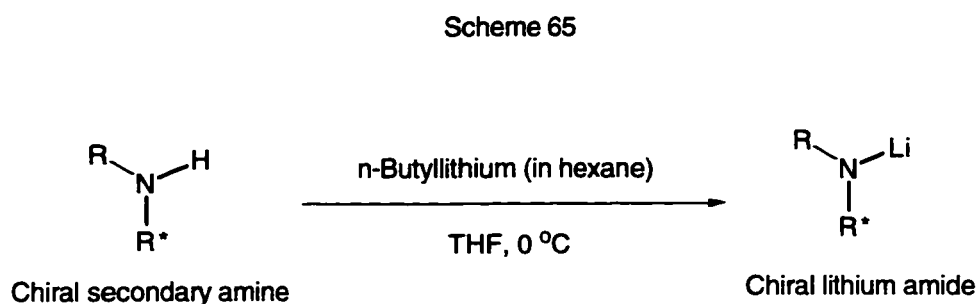

Fig. 2.2. Tropinone, tropinone lithium enolate and π - σ^* orbital interactions favoring abstraction of the axial hydrogen

2.1. Enantioselective deprotonation of tropinone with chiral lithium amides

Reaction of tropinone with the chiral lithium amide, prepared from a chiral secondary amine (Scheme 65), should result in the formation of an enantiomerically enriched (scalemic) product of deprotonation i.e., lithium tropinone enolate (cf., chapter 1 section 1).



Because kinetic deprotonation reactions of ketones with LDA are usually run at low temperatures (typically -78°C) in ethereal solvents,^{4b} these standard conditions were used in this study. It was decided to test reactions of tropinone with several different chiral lithium amides. A previous study on tropinone deprotonation done in our laboratory by G.-Z. Zheng showed that three bases **443a**, **447a**, and **442a** were the most promising reagents (Scheme 66, Table 2.1). The bidentate amide **447a** prepared from the phenylglycine derivative **447**, gave the best (60% ee) selectivity of all the bases tested.

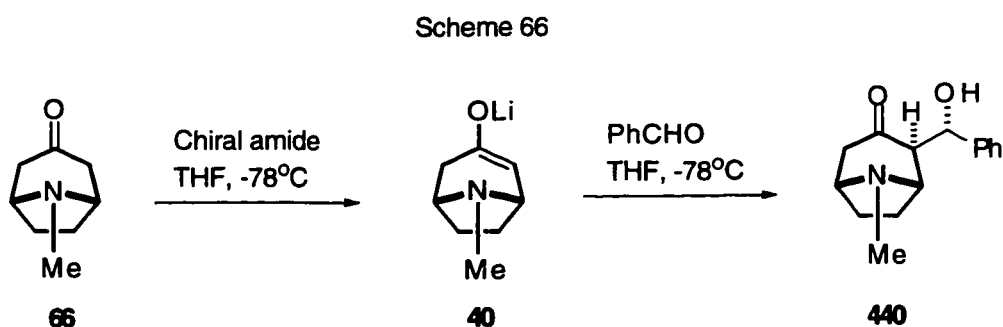
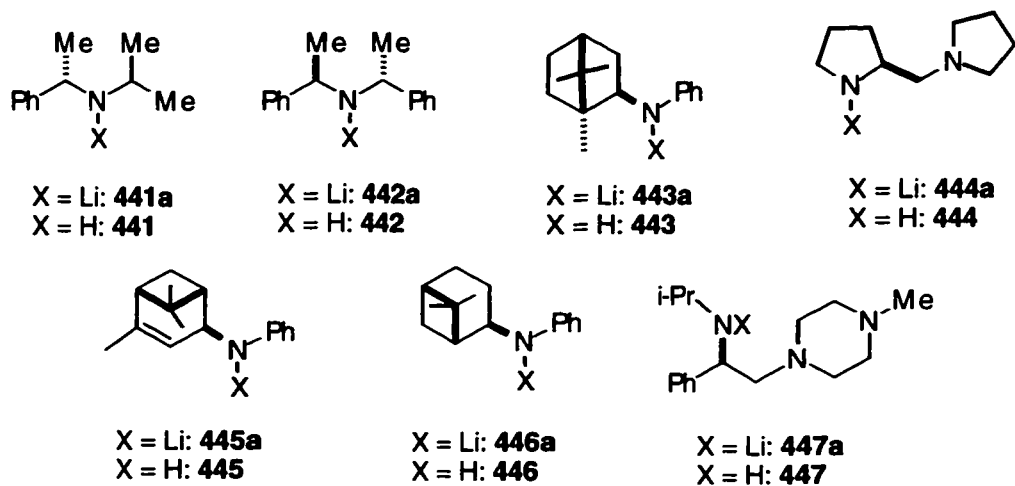

Table 2.1. Enantioselectivity of deprotonation of tropinone observed previously in our laboratory by G.-Z. Zheng.

entry	Li amide	% ee*	% yield of 440
1	447a	60	64
2	442a	40	84
3	443a	40	75
4	441a	34	88
5	446a	26	70
6	445a	16	97
7	444a	8	85

* Measured by proton NMR in the presence of (+)-Eu(tfc)₃.



As reported by Koga and Momose, some of the best enantioselectivities in deprotonation of other cyclic ketones were observed with bidentate chiral lithium bases of the type **447a**.^{7,10} Because of that my attention was focused primarily on the group of lithium amide bases derived from bidentate amines **447-450**. It was hoped that a reagent providing synthetically useful enantioselectivity would be found among them.

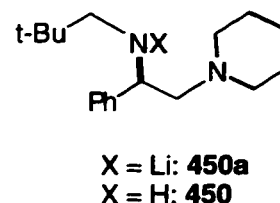
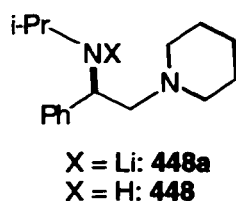
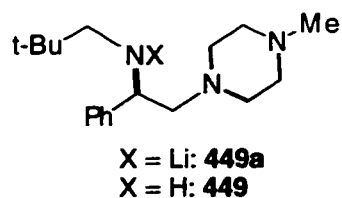
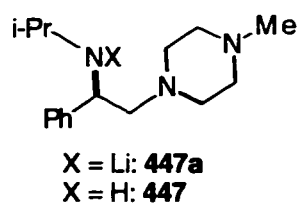

Before the deprotonation experiments could be undertaken, the chiral amines had to be synthesized since they were not commercially available. The literature procedures for their synthesis were incomplete and proved troublesome in our hands.¹⁵⁶ Ideally, the synthesis of these compounds should be inexpensive and amenable to scaling up. Because chromatography is an expensive and tedious technique for large scale preparations it should be avoided. After some experimentation, the synthesis was accomplished as shown in Scheme 67. During the course of these syntheses a few difficulties had to be overcome. The removal of t-butyl alcohol from the t-Boc protected amino acid was troublesome and had to be accomplished by azeotropic distillation with CH₂Cl₂. The purification of the amide **451a** could be achieved by chromatography but crystallization from hexane was more convenient on a large scale. Because even small impurities in the chiral amines used in the enantioselective deprotonation have a detrimental effect on selectivity (*vide infra*) the method for a thorough purification of the synthesized (or recovered from previous experiments) amines had to be worked out.

Scheme 67

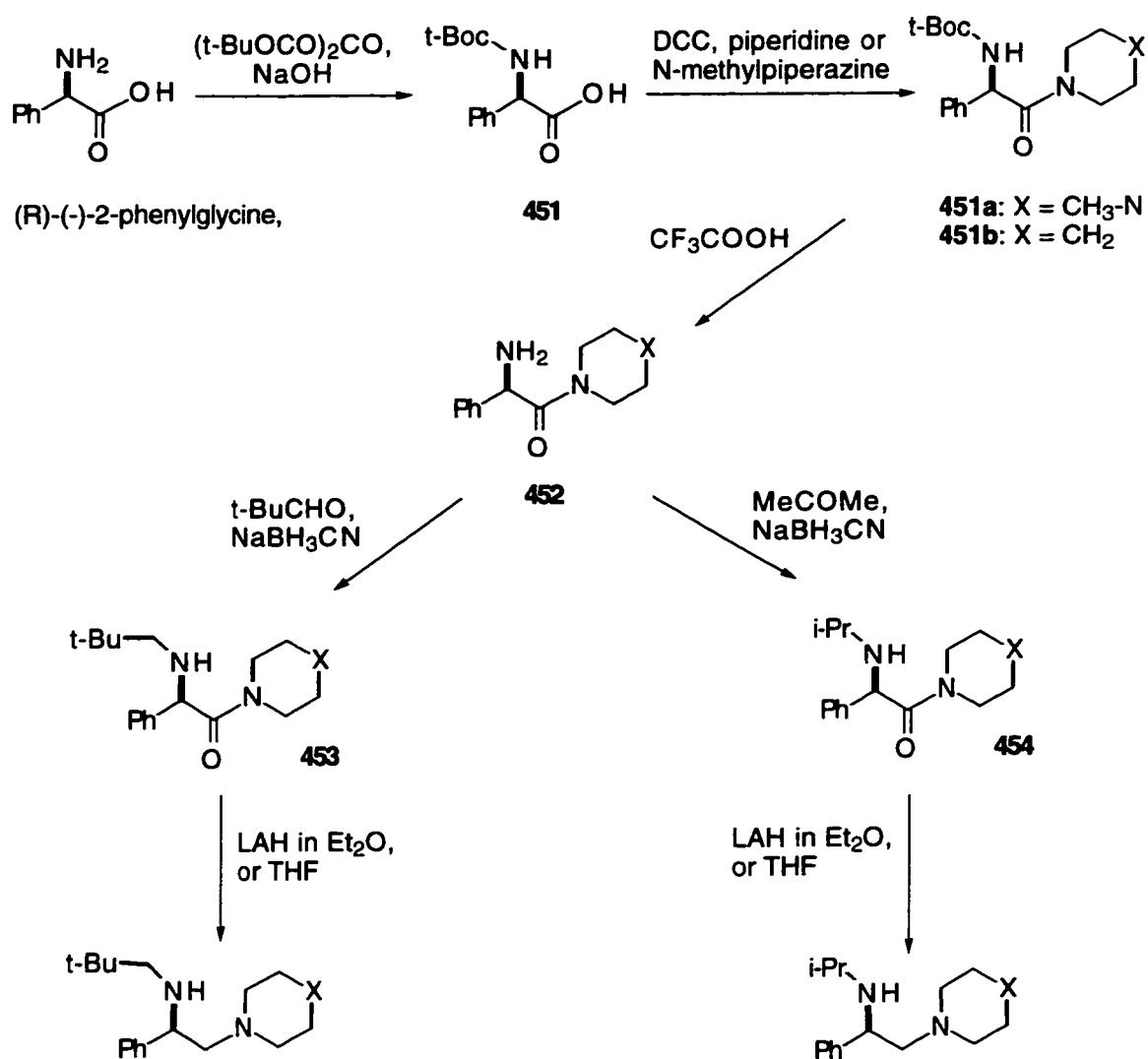

450: X = CH₂
 colorless oil purified by
 filtration through SiO₂
 and vacuum distillation
449: X = N-CH₃
 white solid purified by
 crystallization of 3 HCl
 salt from EtOH and
 vacuum distillation of
 the free amine

448: X = CH₂
 colorless oil purified
 by vacuum distillation
447: X = N-CH₃
 colorless oil purified
 by vacuum distillation

The final product **449** was purified by crystallization of the trihydrochloride salt from EtOH followed by conversion to the free amine and by vacuum distillation in the Kugelrohr apparatus. The Kugelrohr distillation was used because the amine **449** readily solidifies if sufficiently pure. The HCl salt of the other neopentyl derivative **450** did not crystallize well and an alternative method had to be found. Since the amine product and the impurities differed markedly in polarity the purification on an 8 g scale was achieved by filtration through silica gel followed by distillation in a short path apparatus. The isopropyl derivatives **448** and **447** could be purified in the same way. The purities of all the chiral amines were determined by GC analysis.

Another type of chiral secondary amines which were studied were the bases derived from α -methylbenzylamine. They are relatively cheap and easy to synthesize on a large scale. The preparation of the C_2 symmetric amine **442** was simple and follows a literature procedure¹⁵⁴ with slight modifications (Scheme 68). The second stereogenic center was formed in the palladium catalyzed hydrogenation of the chiral imine **456**. The diastereoselectivity of this reaction was about 9:1 as shown by the ratio of the chiral product **442** and the meso diastereomer **457** (GC analysis). The diastereomerically pure amine **442** was obtained by crystallization of the hydrochloride salt of **442** followed by a conversion to the free amine and distillation. The 1-naphthyl derivative **460** was prepared by hydrogenation of the imine **458** in a methanol solution, from which crystallized diastereomerically pure **460**.

Scheme 68

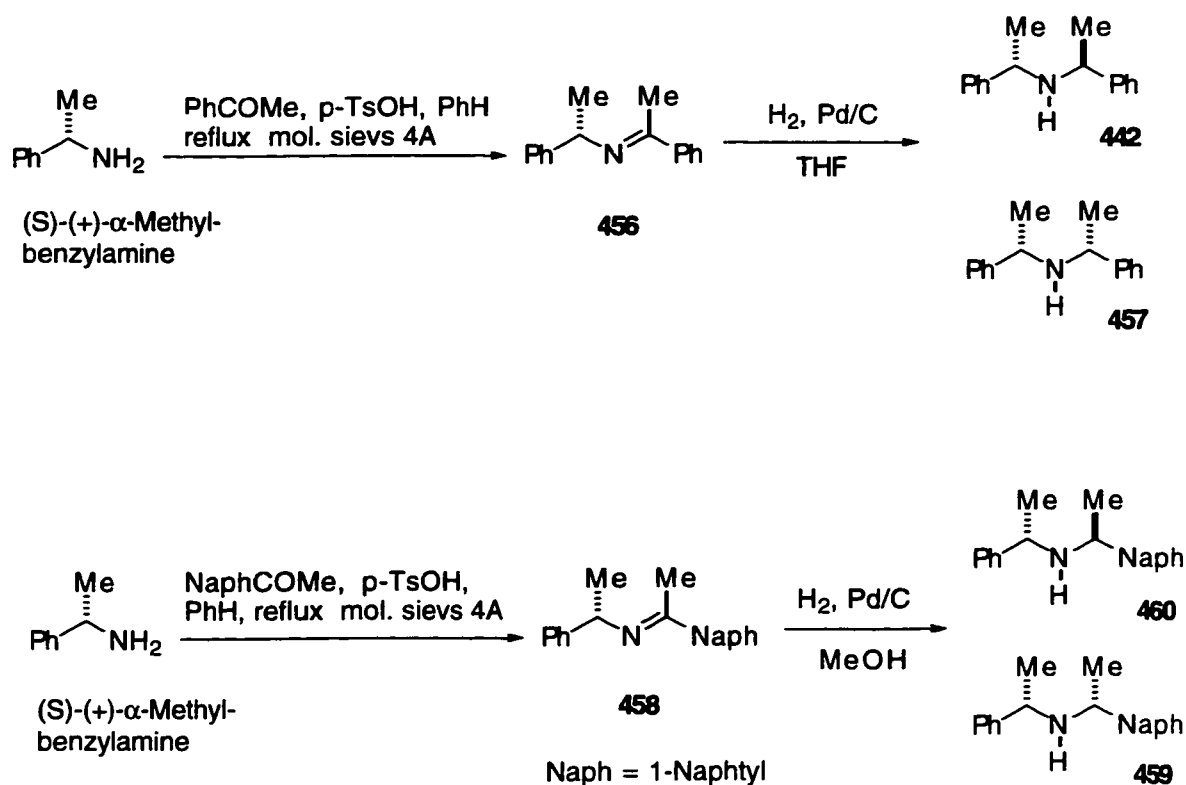

Some chiral secondary amines were prepared from α -methylbenzylamine or from chiral terpenes by "a one pot" reductive amination reaction (Scheme 69). The reductive amination was most conveniently accomplished in "one pot" by reduction with sodium cyanoborohydride (Borch method¹⁵³) as demonstrated by the synthesis of **441**. The chiral derivative of aniline **462**, previously obtained by Wittig,¹⁵² was prepared by an aromatic nucleophilic substitution reaction (Scheme 69). Preparation of the camphor derivative **443** consisted of two steps i.e., formation of the imine and then stereoselective reduction to the amine. The stereoselectivity of the reduction of imine with NaBH₄ originated from the steric bias associated with the bicyclic structure of the camphor skeleton.

Scheme 69

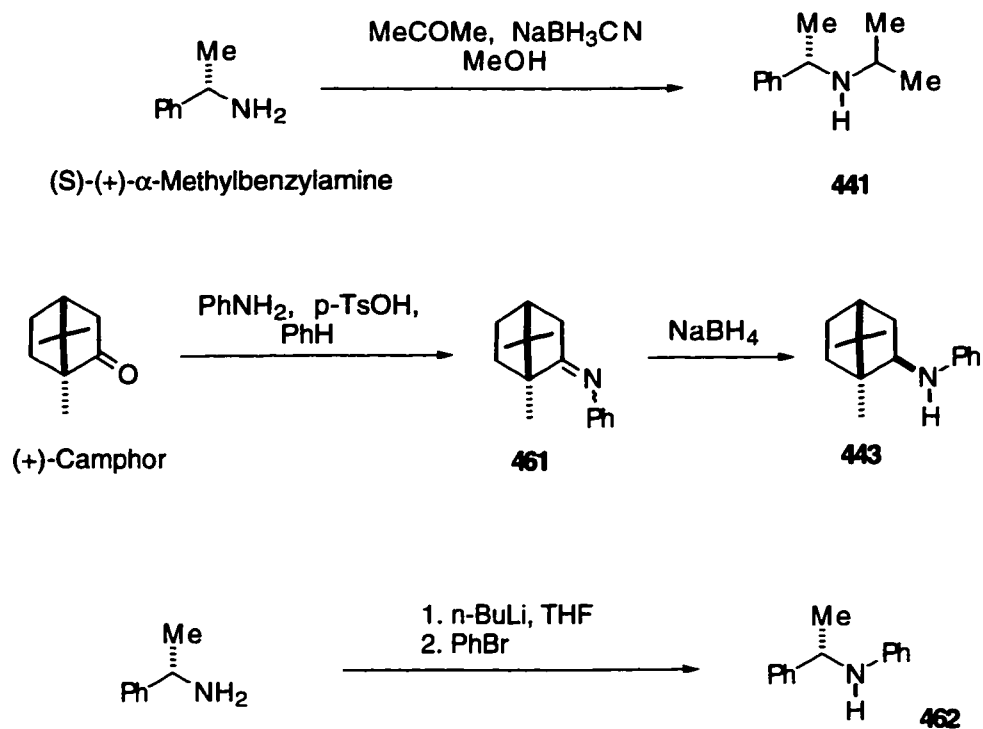

The availability of the chiral amines to be used for the *in situ* generation of the chiral lithium amides was not the only requirement which had to be met before a study of the enantioselectivity of deprotonation could be undertaken. The other essential element was finding a way of measuring the enantiomeric excess (ee) of the reaction product. In a simple way the product of deprotonation of tropinone can be seen as tropinone lithium enolate (**40**). The tropinone lithium enolate is a very reactive substance and cannot be easily isolated. Thus, the enantioselectivity of deprotonation (which is expressed in the enantiomeric excess of the enolate product) cannot be directly measured. Instead, the enolate can be treated with an electrophilic reagent to form a stable and easy to isolate product. The enantiomeric excess of the product of reaction with the electrophile can be used as an indirect measure of the

enantiopurity of the lithium enolate, provided that analytical methods for determination of the isolated product's ee can be found. The analytical techniques for direct measurement of the enantiomeric excess of a chiral compound include NMR spectroscopy in the presence of chiral additives, chromatography on chiral materials and polarimetry.¹⁴⁴ The direct measurement of ee by NMR, GC or HPLC is possible only if the satisfactory separation of the enantiomer peaks in the NMR spectrum or in the chromatogram can be obtained. This is often difficult and requires much time and effort. The compound, in question has to be first obtained in the racemic form, which can serve as a standard. The various, available analytical methods are then tested in order to find the best protocol for the ee analysis. If the direct procedures fail, then indirect methods of measurement of enantiomeric purity, based on derivatization with chiral optically pure reagents and measurement of the diastereomeric excess by NMR or chromatography (GC or HPLC) may be successful.¹⁴⁴ This again might be a very time consuming and tedious endeavor.

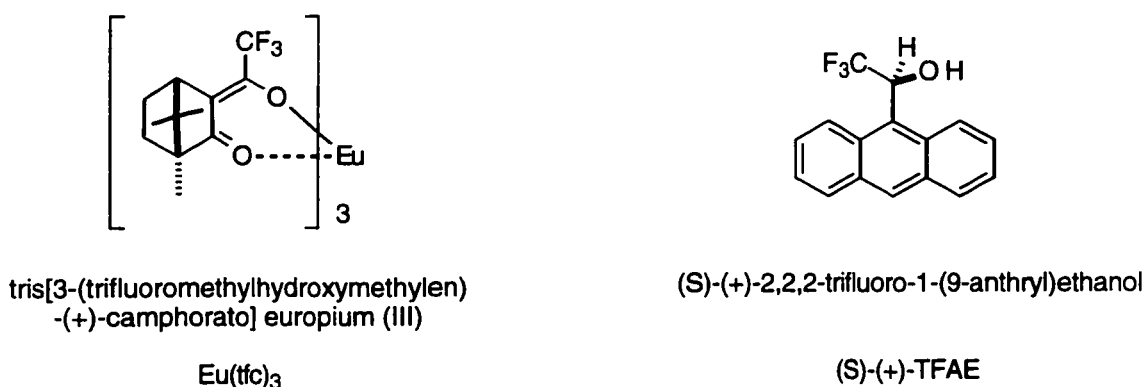

Fig. 2.3. Structures of chiral lanthanide shift reagent and chiral solvating agent used for ee analysis of aldol **440**

The reaction of tropinone lithium enolate with benzyl chloroformate (Cbz-Cl) at -78°C in THF takes place on the nitrogen terminus of the enolate and gives good yields of the product of pyrrolidine ring opening **465** (Scheme 70).¹³ The α,β -unsaturated ketone **465** is a potentially valuable intermediate which could lead to several groups of alkaloids (cf. Scheme 63).

My first study of tropinone deprotonation with chiral lithium amides was based on this reaction. The racemic product **465** was obtained by deprotonation of tropinone with LDA (Scheme 70). Unfortunately, I could find no technique which was able to differentiate between the enantiomers of **465**. The only method for determination of enantioselectivity of this process was the measurement of the optical rotation of chromatographically purified product **465**. When this study was done, the specific rotation of the optically pure enone **465** was not known, and the specific rotation data could be used solely for relative comparison of enantioselectivity of the deprotonating reagents. The results are presented in Table 2.2 and indicate that the lithium amides **449a** and **450a** are more selective reagents than **447a** or **448a**. This fact can be rationalized on the grounds of increased steric bulkiness of the neopentyl group compared to the isopropyl group.

Scheme 70

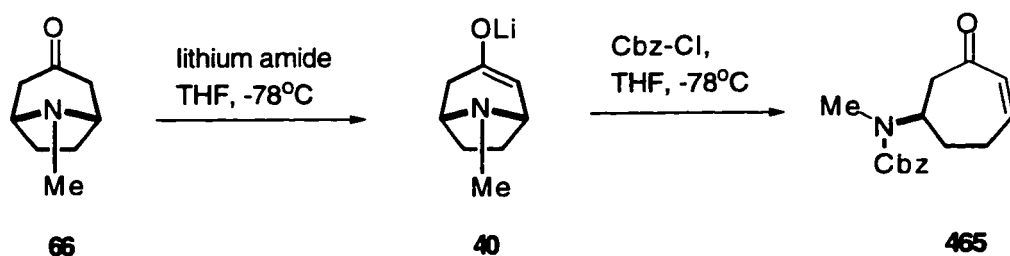

Table 2.2. Relative enantioselectivity of deprotonation of tropinone by chiral lithium amides derived from phenylglycine.

entry	lithium amide	yield (%)	specific rotation	% optical purity*
1	449a	30	+51.6	70
2	450a	63	+48.6	66
3	447a	41	+31.7	53
4	448a	68	+38.3	52
5	441a	80	+30.0	44

* The optical purities are approximate.

This study on the reaction of tropinone lithium enolate with benzyl chloroformate indicated that chiral lithium amides prepared from the neopentyl derivatives **449** and **450** were the most selective. However the study did not provide a reliable measure of the enantioselectivities of these reagents, due to a lack of method for determination of the enantiomeric excess of **465**. During the investigation of reactions of the tropinone lithium enolate with other electrophiles, it was found that reaction with senecioid cyanide took place on the carbon terminus of the enolate, and gave an excellent yield of diketone **466**. The virtually quantitative cyclization of the diketone **466** under basic conditions yielded the dihydropyranotropane **467**. As it turned out, the enantiomeric purity of product **467** could be accurately determined by chiral HPLC (ChiraDex column from Merck). The dihydropyranotropane **467** was isolated by extraction and purified chromatographically. The product was relatively easy to purify from the chiral amine **450**, however, serious difficulties were encountered in the separation of the piperazine derivative **449** due to its higher polarity. Thus, only the second best deprotonating reagent, amide **450a** and the simple amide **441**, were used in the experiments with senecioid

cyanide. As indicated by the data in Table 2.3 the selectivity was at best 85% ee. Interestingly, the slight impurity (no more than 4%) of the amine lowered the ee of the product by 4%. The results indicate that the purity of the amines used in the deprotonation experiments is crucial for obtaining optimal selectivities and reproducibility of results.

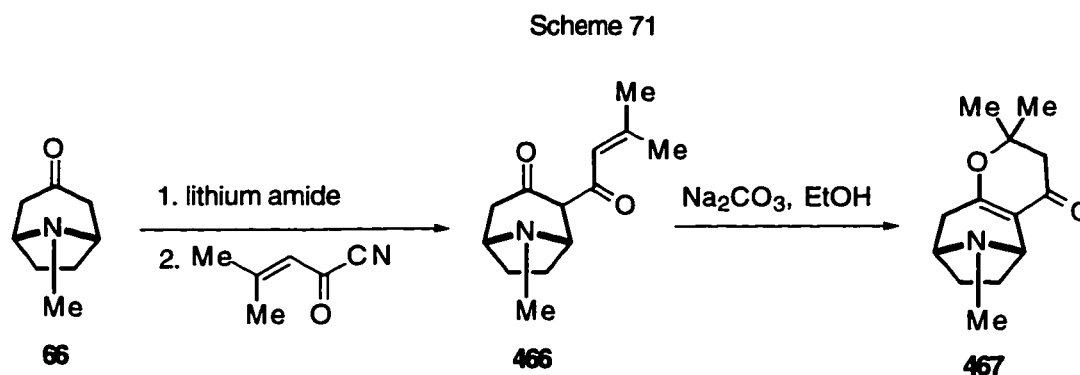

Table 2.3. Enantioselectivity of deprotonation of tropinone probed by the acylation reaction

entry	lithium amide	%ee	% yield
1	450a	85	98
2	450a*	81	88
3	441	40	73

* The amine was only 96% pure by GC analysis.

Another reaction which could be used to probe the enantioselectivity of deprotonation was the aldol addition reaction between benzaldehyde and the tropinone enolate, which was known to yield only one diastereoisomer of the aldol product.¹³ The ratio of the area of the *N*-methyl signals in the proton NMR spectrum of the aldol **440** taken in the presence of tris[3-(trifluoromethylhydroxymethylen)-(+)-camphorato] europium (III) [Eu(tfc)₃] could provide a direct measure of the enantiomeric excess. However a more

accurate measurement of the ee of aldol **440** was possible when the chiral solvating agent (*S*)-(+)-2,2,2-trifluoro-1-(9-anthryl)ethanol [(*S*)-(+)-TFAE] was used instead of the lanthanide shift reagent. This was due to a good separation of the benzyl hydrogen doublets in the presence of (*S*)-(+)-TFAE and to a lesser line broadening as compared to the lanthanide shift reagents. The advantage of using the aldol for direct measurement of the ee by NMR on the crude product was twofold: The procedure was relatively fast, and more importantly, the enantiopurities of the products were not changed by subsequent reactions or purifications (e.g., flash chromatography). The purities of all the amines used in these experiments were better than 98.5% as indicated by GC. The results are presented in Table 2.4 and indicate that the amide **450a** was the only reagent giving a synthetically useful selectivity (91% ee).

Scheme 72

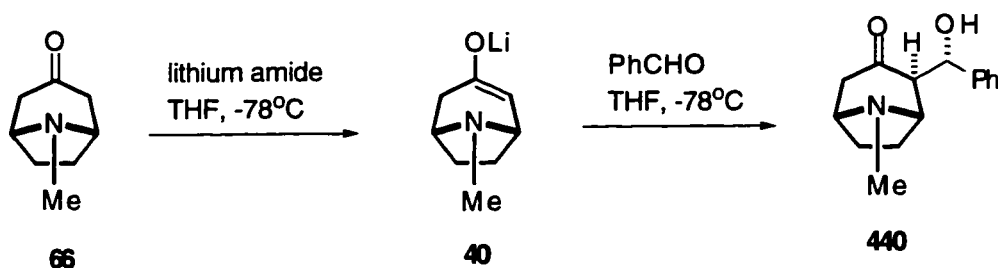

Table 2.4. Enantioselectivity of deprotonation of tropinone probed by the aldol reaction

entry	amide	%ee	% yield
1	441 a	23	93
2	462 a	23	86
3	442 a	36	91
4	450 a	91	89

When the enantiomeric purity higher than 90% ee was observed the question arose of the accuracy of the measurements of ee by NMR. The accuracy of integration in proton NMR is at best about 1%.¹⁴⁰ Thus, it would appear impossible to measure the enantiomeric excess of samples of high optical purity (e.g., 98%), especially if the error of integration of the area under the peak of the minor enantiomer was high. However, it can be shown that high enantiomeric excess can be determined quite accurately. For example let us assume that we are determining the enantiomeric excess of a sample of known and high enantiopurity (e.g. 98% ee) by integration of proton NMR signals. For 98% ee we would expect the ratio of the integrated areas to be 99:1. Let us also assume that in practice the errors of integration are higher than the best theoretical value (1%), particularly for the minor enantiomer. Thus the reasonable assumption for the values of relative errors could be 5% and 30%, for the major and the minor enantiomer, respectively.¹⁴¹

major peak area $99 \pm 5\%$ i.e., area between 94.05 and 103.95

minor peak area $1 \pm 30\%$ i.e., area between 0.70 and 1.30

According to the formula defining percentage enantiomeric excess,

$$ee = [(R - S)/(R + S)] \times 100\%$$

where R and S stand for the concentration or the amount (which in our case is represented by the area under NMR signal) of the major and the minor enantiomer respectively, the worst possible combination i.e., 94.05:1.30 would translate into 97.3% ee and the best possible combination i.e., 103.95 : 0.70

would give 98.7% ee. That means the result of the measurement would be 98% ee and the absolute error should not be higher than 0.7% ee.

This shows that even with a large (30%) relative error of measurement of the minor signal, the enantiopurity of 98% ee can be measured accurately.

In practice the uncertainty of determination of enantiopurity by NMR is often associated with random errors due to e.g., the arbitrary choice of integration regions, especially when the integrated signals are not perfectly separated from other peaks in the spectrum. In order to test the practical reliability of NMR for analysis of enantiomeric purity well above 90% the errors of measurement were estimated statistically. The NMR spectrum of an enantiomerically enriched sample was recorded in the presence of the chiral solvating agent ((*S*)-(+)-TFAE) ensuring a high signal to noise ratio (cf., experimental section). The phase correction and the integration of the two signals corresponding to both enantiomers was then performed to produce 10 independent results which are shown in Table 2.5.

Table 2.5. Results of measurements of ee by integration of NMR signals for highly enantiomerically enriched sample.

entry	1	2	3	4	5	6	7	8	9	10
%ee	94.9	94.7	97.1	97.0	98.4	97.4	97.0	97.1	97.8	96.9

The mean and the standard deviation (*s*) of ee are 96.8 and 1.2 respectively. The 95% confidence interval for 10 replicates is expressed by $2.26 \times s/n^{1/2}$, where *s* is the standard deviation and *n* is the number of replicates.¹⁴² For the described series of results *n* = 10, and estimated standard deviation *s* = 1.2. So the 95% confidence interval equals 0.86. If the same procedure is used to analyze samples with similar enantiopurity the standard deviation of the

method should remain unchanged. Thus the estimated standard deviation can be used to predict the reliability of results obtained by e.g., 2 replicate measurements. In the case of two replicate measurements, this method should give results with a 95% confidence interval of $2.26 \times 1.2/(2)^{1/2}$ i.e., $97 \pm 2\%$ ee. As a result the enantiomeric excess of about 97% ee can be measured quite reliably by NMR provided good separation of signals and high signal to noise ratio can be obtained. The precision of measurements of enantiopurities reported in the thesis were estimated in the way analogous to described above.

2.2. Effects of lithium salts on deprotonation of tropinone

It has been observed that the selectivity of deprotonation with lithium amides can be changed in the presence of lithium salts (cf., chapter 1).^{25,27} It has also been reported that lithium diisopropylamide (LDA) forms mixed aggregates with lithium chloride (Scheme 73).²³ By analogy with LDA, mixed aggregates formed from chiral lithium amides and LiCl would be new deprotonating reagents and could exhibit different and, perhaps increased enantioselectivity in deprotonation reactions.

Scheme 73

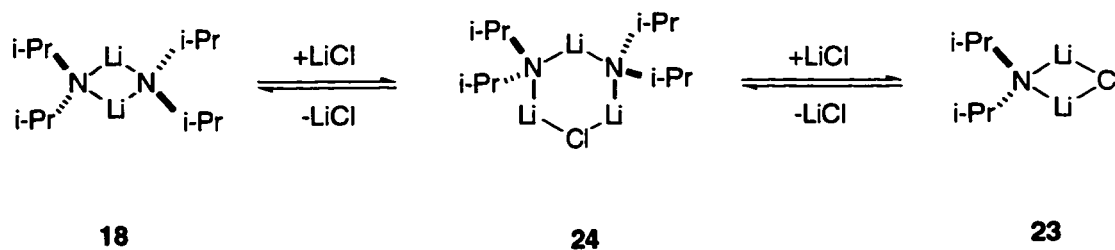

One should expect that reactions leading to the formation of aggregates are reversible and the addition of a lithium salt could lead to several equilibria (Scheme 73). Since all three aggregates; the amide dimer, the 2:1 complex and the 1:1 complex of the amide with LiCl are viable deprotonating species, and probably differ in reactivity and selectivity, the enantioselectivity of deprotonation would depend on the relative concentrations of these aggregates. These relative concentrations, should on the other hand, depend on the molar ratio of the lithium salt additive and the lithium amide. It was decided to test the enantioselectivity of deprotonation of tropinone by mixtures containing chiral lithium amide and variable amounts of LiCl.

The first deprotonation reaction for which the lithium chloride effect was observed was the formation of the ring opening product **465**. The dependence of optical purity of the reaction product (Scheme 74) on the amount of added LiCl is shown in Table 2.6 and in Figure 2.4. It was clear that the optical purity of the product markedly increased with the addition of LiCl. However, since the difference between the results of experiments with 0.5 equiv (62%) and 2 equiv (57%) of the additive were within the experimental error of the method it was hard to decide if the curve in Figure 2.4 reaches a maximum at 0.5 molar equivalent.

Scheme 74

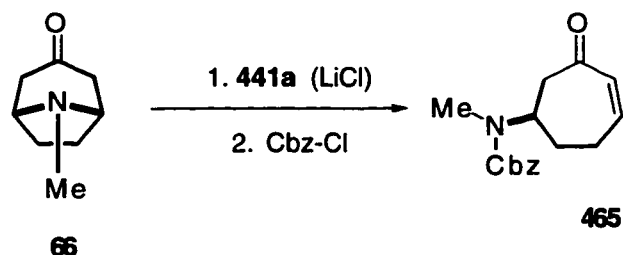

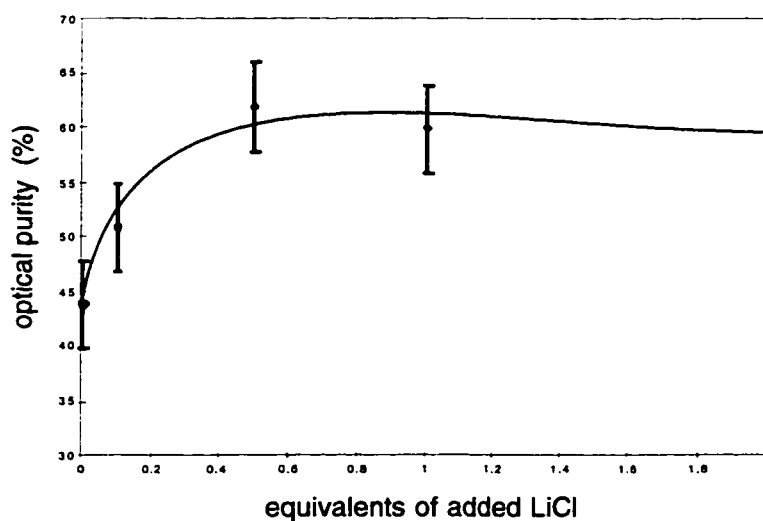

Fig. 2.4. Effect of added LiCl on optical purity of **465**

Table 2.6. Effects of addition of LiCl on enantiopurity of benzyl carbamate **465**

entry	amide	# of eq of LiCl	%optical purity*	% yield
1	449a	0	70	51
2	449a	0.5	93	51
3	449a	1	92	50
4	441a	0	44	59
5	441a	0.1	51	46
6	441a	0.5	62	57
7	441a	1.0	60	54
8	441a	2.0	57	53

* The optical purity is approximate. Estimated experimental errors are $\pm 4\%$.

This observation was promptly used to increase the enantioselectivity of the most effective deprotonating reagent at hand i.e., the bidentate amide **449a**. The optical rotation data showed a substantial increase in the optical purity of the product **465** (Table 2.6 entry 1, 2 and 3). As indicated by the data in Table 2.6. the optical purity rose from modest (70%) to high (93%) on addition of 0.5 molar equivalents of LiCl. It was then decided to verify and expand those

preliminary results using a more accurate method of analysis of enantiopurity and to test the generality of the LiCl effect on another reaction.

The reaction of tropinone enolate with senecioid cyanide was studied next. Tropinone was deprotonated by a mixture of the chiral lithium amide **450a** and LiCl and the formed tropinone lithium enolate was treated with an acyl cyanide electrophile. The product was isolated and cyclized to the corresponding dihydropyranotropane (Scheme 75) which was chromatographically purified and subjected to the HPLC analysis on a column with a chiral stationary phase. The results are summarized in Table 2.7. The dependence of enantioselectivity of deprotonation on a number of equivalents of added LiCl is shown in Figure 2.5. The data obtained in this study are in agreement with the previously observed effects (reaction with benzylchloroformate) i.e., the addition of LiCl increased the selectivity. However, the overall boost of selectivity was smaller and it seemed that the maximum was observed upon the addition of 0.5 mole of lithium chloride per 1 mole of chiral lithium amide. The discrepancy between the results presented in Figures 2.4 and 2.5 may be due to the different nature of the two lithium amides (**441a** and **450a**) or the different character of the electrophile (cf., chapter I).

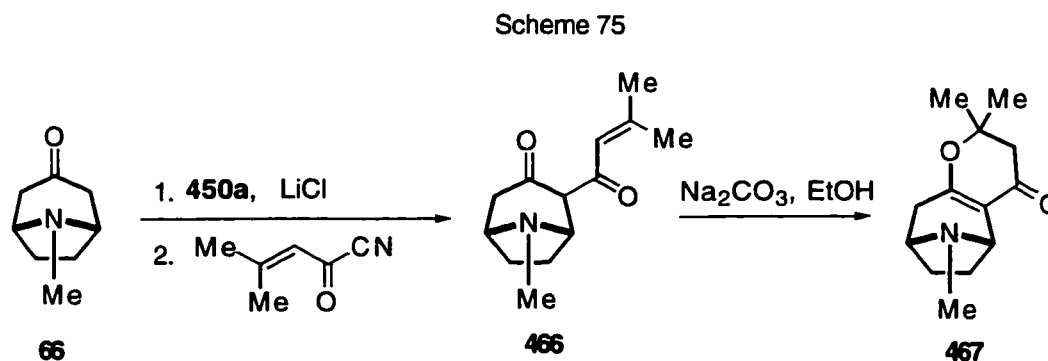
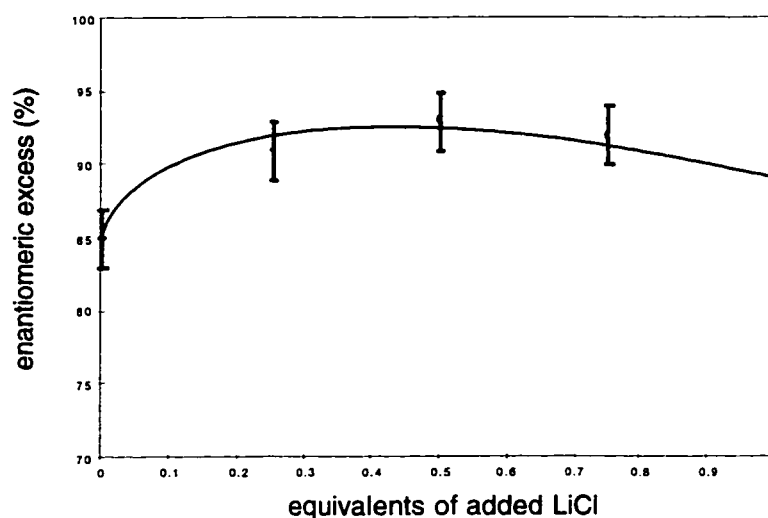

Table 2.7. The effect of addition of LiCl on acylation of tropinone

entry	# of eq of LiCl	%ee	% yield
1	0.0	85	98
2	0.25	91	72
3	0.50	93	96
4	0.75	92	84
5	1.0	88	78

Estimated experimental errors are $\pm 2\%$ ee

Fig. 2.5. Effect of added LiCl on enantiopurity of **467**

The increase of enantioselectivity of deprotonation on addition of LiCl seemed to be a general effect independent of the electrophile used as shown by reactions with cinnamoyl cyanide, methyl cyanofornate, and benzaldehyde (cf., synthetic studies). It was interesting to check if the effects observed on the simple amide **441a** and the bidentate amide **450a** would be observed on other lithium amides. The effects were tested through the analysis of the ee of the aldol reaction product **440** (Scheme 76).

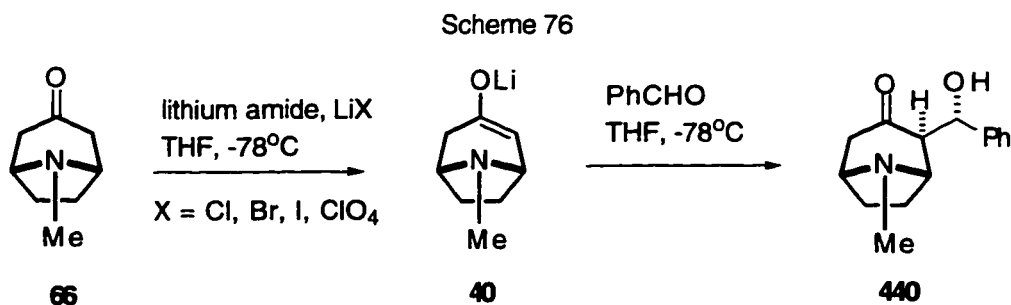

The enantiomeric excess of the aldol product **440** was measured by proton NMR in the presence of the chiral solvating agent (*S*)-(+)-TFAE. The results are summarized in Table 2.8 and Figures 2.6 and 2.7.

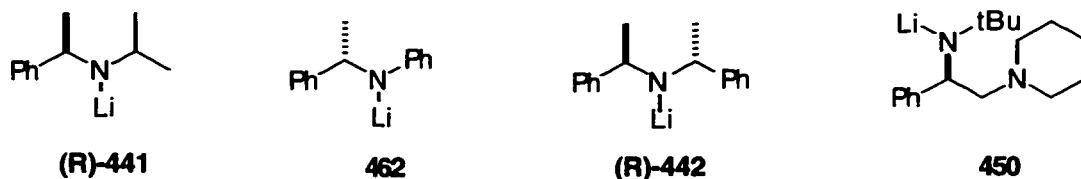

Table 2.8. Influence of lithium chloride on enantiomeric excess of aldol **440** prepared by deprotonation with chiral amides.

# of LiCl eq	enantiomeric excess (%)				
	(R)-441a	462a	(R)-442a	450a	450a*
0.0	23	23	36	91	44
0.10	55	28	61	95	-
0.25	68	35	79	92	57
0.50	74	39	87	94	55
1.0	71	45	90	94	56
1.5	73	-	89	94	58
2.0	72	50	91	94	60

*reaction was run in Et₂O instead of in THF

It is apparent that the three monodentate amides **441a**, **442a** and **462a** showed significant LiCl effects, while the bidentate amide **450a** showed a very

small effect. The C_2 symmetric amide/LiCl mixture showed high selectivity comparable with the selectivity of amide **450a**. One can conclude that the effect is general for monodentate amides for which markedly increased enantioselectivity was observed on addition of about half an equivalent of LiCl.

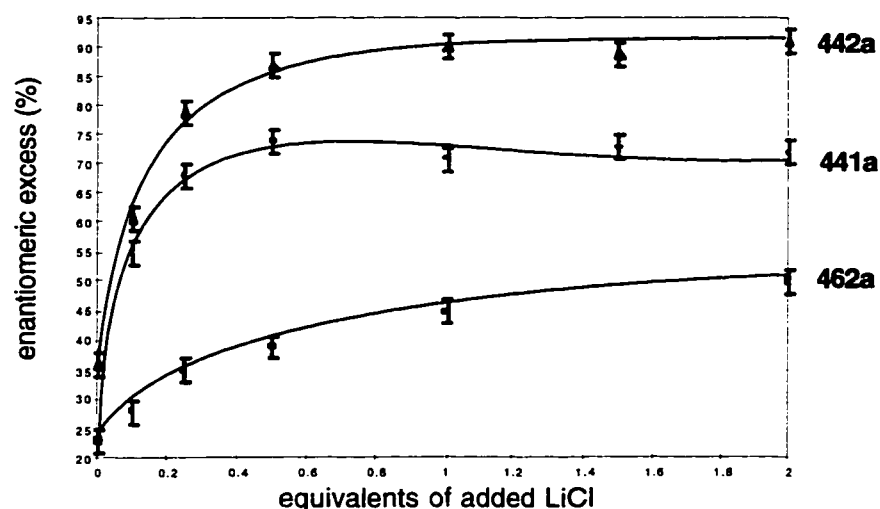

Fig. 2.6. Effect of added LiCl on enantiopurity of **440**

On the other hand the addition of LiCl had almost no effect on deprotonation with the bidentate amide probed by the aldol reaction. The addition of LiCl, however, did not have any detrimental effect on the enantiopurity of the aldol product **440** but did cause little increase of enantiopurity of the products of acylation and ring opening reaction with benzyl chloroformate. Thus addition of lithium chloride can be recommended for deprotonation reactions with both bidentate and monodentate lithium amides.

The lowered enantioselectivity of the reaction in diethyl ether was in agreement with a previous observation^{18a} and indicated that THF is the solvent of choice for enantioselective deprotonation. The lithium amide **450a** was shown to form a dimer in the Et₂O-toluene mixture and a monomer in THF.¹⁸ The higher selectivity in THF can thus be attributed to the monomer

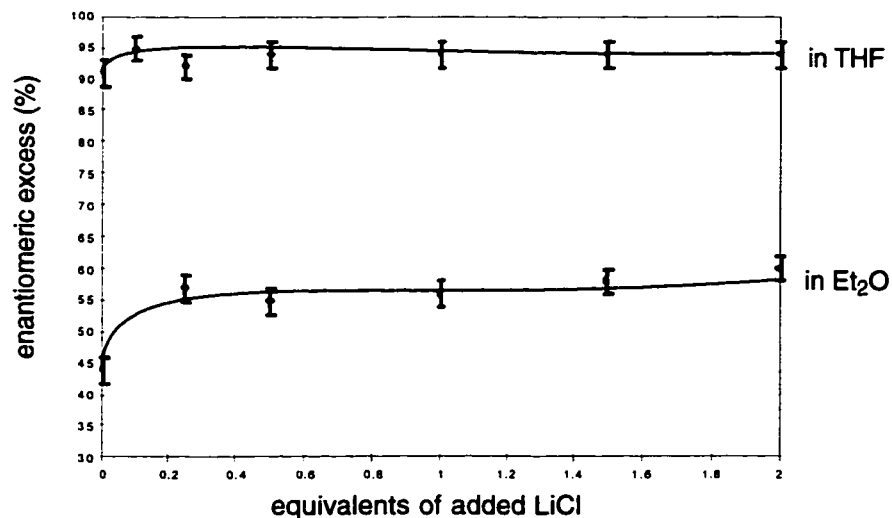
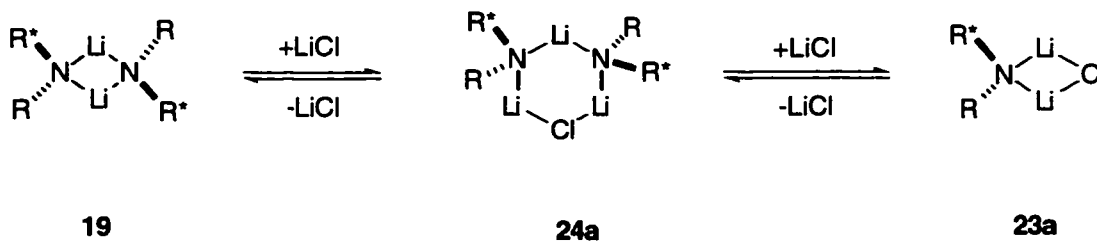

Fig. 2.7. Effect of added LiCl on enantioselectivity of deprotonation with **450a**.

of **450a**. The effect of added LiCl was stronger in Et₂O than THF. That can be rationalized on the basis of the interaction of LiCl with the dimeric aggregate of the bidentate amide **450a**. The added LiCl could cause the deaggregation of dimers of **450a**.

Scheme 77



The characteristic feature of the curves in Figure 2.6 is the sharp rise between 0 and 0.1 equiv of added salt. This means that even a small amount of lithium halide present in the reaction mixture could change the enantioselectivity substantially. Since the butyllithium used for preparation of

the chiral lithium amides is typically prepared from n-butyl halides,¹⁴⁸ halide impurities could be present in the commercial n-butyllithium. The batch to batch variation of the halide content could make the reproducibility of results impossible.

It was decided to find out the concentration of chloride, bromide, and iodide in commercially available butyllithium (2.5 M solution in hexane available from Aldrich). A known volume of the n-butyllithium solution (e.g., 1 mL) was added to methanol and diluted with water to make up volume of 100 mL. Aliquots of that solution were analyzed by cyclic voltammetry. The analysis estimated the concentration of Cl⁻ to be less than 0.007 M. The concentrations of bromide and iodide were even smaller. Thus, the n-butyllithium used in my studies contained less than 0.0028 mole of halide per mole of n-butyllithium. This meant that the halide impurities present in the analyzed batch of the reagent are negligible and should have no effect on enantioselectivity.

Until more data becomes available, we can only speculate as to the origin of the observed dependence of selectivity on the amount of LiCl additive. At the moment it appears that enantioselectivity of the process of deprotonation is a function of two equilibrium constants, six reaction rates (rates for two diastereomeric transition states for each of the 3 reactive forms of Li amide), and the initial ratio of LiCl/Li-amide. The data available include selectivity of deprotonation (i.e., ratio of rates of formation of the two enantiomeric enolates) for one of the reactive forms of amide (the dimer **19**) and dependence of the selectivity of the overall process on the ratio of LiCl/Li-amide. Since most of the data needed for the interpretation of the curves in Figure 2.6 are not known, one can only give an hypothetical explanation of observed phenomena based on far reaching assumptions. For example, if the 2:1 aggregate **24a** exhibits

the highest selectivity and the highest reactivity of the three forms **19**, **23a**, **24a** and is favored in equilibrium, one would expect that the curves will level at 0.5 equiv of LiCl. By the same token, if the 1:1 aggregate **23a** dominates in the equilibrium and is most selective, the maximum selectivity should be obtained at 1 equiv of additive and should not change at a higher ratio of LiCl/Li amide. If, however, both forms **23a** and **24a** are equally selective and equally favored in equilibrium the curve should reach a plateau at 0.66 equiv of LiCl. On the other hand if the selectivity of lithium chloride aggregates **23a** and **24a** is different and these aggregates are equally favored in equilibrium over the dimer **19**, one could expect a change of the selectivity after the 0.66 equiv of additive. That is the selectivity should rise or diminish after the 0.66 equiv point depending on which of the species **23a** or **24a** is more selective. Since the curves level between 0.5 and 1 equivalents of added LiCl the scenario based on the last assumption is rather unlikely.

It was observed in our laboratory that addition of other salts can have some effect on enantioselectivity (cf. chapter I) e.g., M. Gleave reported that lithium bromide changed the enantioselectivity of deprotonation of 2,6-dimethylcyclohexanone.²⁷ Simpkins, however, reported that LiF, LiBr and some other salts had no influence on enantioselectivity of deprotonation of cyclic ketones.²⁵ It was decided to briefly investigate if other lithium halides and lithium perchlorate will exhibit effects parallel to LiCl. The effect of the addition of these lithium salts on enantioselectivity of deprotonation with the simple amide **441a** and the C₂-symmetrical amide **442a** are shown in Tables 2.9 and 2.10 respectively.

Table 2.9. Influence of lithium salt additives on enantiomeric excess of aldol **440** prepared with amide **441a** .

entry	# of equiv	enantiomeric excess (%)		
		LiBr	LiI	LiClO ₄
1	0.0	23	23	23
2	0.25	67	35	34
3	0.50	71	29	31
4	1.0	69	29	22
5	2.0	73	35	23

Table 2.10. Influence of addition of 1 equivalent of lithium salt on enantiomeric excess of aldol **440** prepared with amide **442a**.

entry	lithium salt	enantiomeric excess (%)
1	–	36
2	LiCl	90
3	LiBr	81
4	LiI	42
5	LiClO ₄	43

Lithium bromide exhibited an effect comparable to LiCl, contrary to a literature report,²⁵ but LiI and LiClO₄ showed virtually no effects. The effect of LiBr can be rationalized on the same grounds as LiCl since structures of aggregates analogous to **468** and **469** have been observed for LDA and lithium bromide.²³

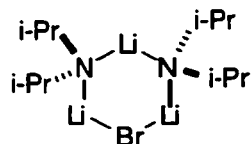

468

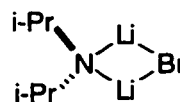

469

2.3. *In situ* generation of lithium amide/lithium chloride mixture and other effects

Since the optimal number of LiCl equivalents for deprotonation with C₂ symmetric amide **442a** was found to be 1, and the selectivity was quite respectable, I have decided to try using the amine hydrochloride instead of the pure amine during the Li-amide generation step. An amine hydrochloride, when treated with 2 equivalents of n-BuLi, would produce a 1:1 mixture of lithium amide (e.g., **442a**) and LiCl. The aldol reaction under these conditions gave the product with 94% ee. The hydrochloride of the amine **442**, unlike the free amine, was easy to purify and store, and was not sensitive to CO₂ or moisture, thus making weighing and manipulations easier. The slightly increased enantioselectivity in the deprotonation experiments with the *in situ* generated lithium amide/lithium chloride mixture can be rationalized by the higher purity of the amide reagent. It was shown before (*vide supra*) that the purity of amine was crucial for maximization of enantioselectivity. Thus, the *in situ* preparation of chiral lithium amide/lithium chloride seemed to be the best and the most convenient procedure for the asymmetric deprotonation of tropinone and possibly other cyclic ketones.

Unexpectedly, during these experiments with amide **441a**, I have observed different selectivity (14, 23 and 43% ee) depending on the rate of addition of the ketone to the preformed lithium amide solution. It was interesting to briefly examine if this effect operates on other reagents, e.g. the C₂ symmetric amide **442a** or its mixture with LiCl. It was found that the selectivity of deprotonation with the chiral amide **442a** was indeed dependent on the rate of addition of tropinone (Table 2.11).

Table 2.11. The effect of the rate of addition of tropinone to chiral lithium amide on enantioselectivity of deprotonation

entry	rate of addition	enantiomeric excess (%)	
		amide 442a	amide 442a /LiCl
1	slow addition (45 min)	44% ee	97%
2	fast addition (1 min)	36% ee	94%

When tropinone was added slowly (45 min) to a Li-amide/LiCl mixture, generated *in situ* from the amine hydrochloride, the crude aldol product showed 97% ee. A substantial change of enantioselectivity (from 36 to 44% ee) was observed when tropinone was added slowly to amide **442a**. Clearly the rate of addition of tropinone can affect enantioselectivity. The rationale for that effect can be trivial e.g., the rise of temperature of the reaction mixture can be responsible for diminished selectivity. The diminished enantioselectivity of deprotonation in diethyl ether vs. THF, both in the presence and absence of LiCl, showed that the effect of the solvent can be most dramatic (Table 2.8, Figure 2.7).

Synthetically useful enantioselectivity of deprotonation of tropinone was achieved in the reaction with either chiral lithium amide **450a** or **442a** run in THF solution at $-78\text{ }^{\circ}\text{C}$ and in the presence of LiCl or LiBr additives. The rate of addition of ketone should be as slow as possible to maximize the enantiopurity of the product (syringe pump is recommended).

2.4. Conclusions

Tropinone was deprotonated by chiral lithium amide **450a** with enantioselectivities between 92-95% ee in a THF solution at $-78\text{ }^{\circ}\text{C}$ in the presence of 0.5 equivalent of lithium chloride. The comparable

enantioselectivity of deprotonation was obtained using the cheaper reagent prepared by addition of 2 equivalents of n-BuLi to the hydrochloride of the chiral amine **442**. Too fast a rate of the addition of tropinone or insufficient purity of the chiral amide resulted in diminished enantioselectivity.

3. Synthetic studies

3. Targets for the synthetic study

In order to demonstrate that the chiral tropinone lithium enolate can serve as a general intermediate for EPC synthesis of various tropane alkaloids, several examples representative of different groups of tropane alkaloids were chosen as targets for the synthesis. Each of the chosen natural products was accessible through different synthetic transformations of tropinone enolate. The target compounds and transformations leading to them include:

a) Anhydroecgonine methyl ester available by *alkoxycarbonylation*:

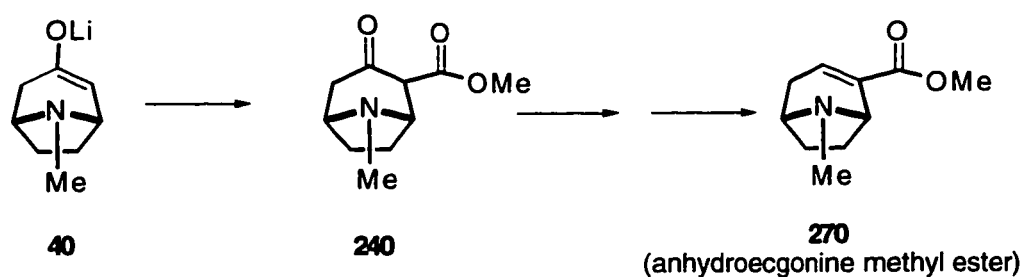

b) Chalcostrobamine available by *acylation*:

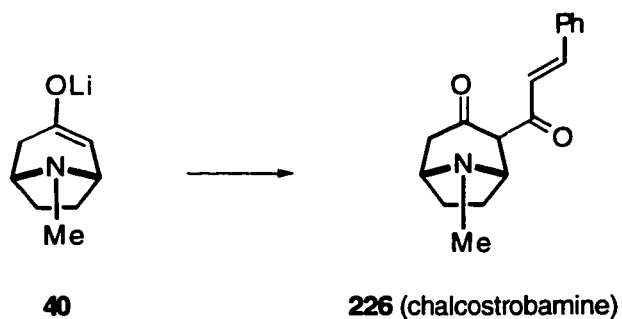

c) Pyranotropanes: Darlingine and isobellendine, available by *acylation* followed by cyclization.

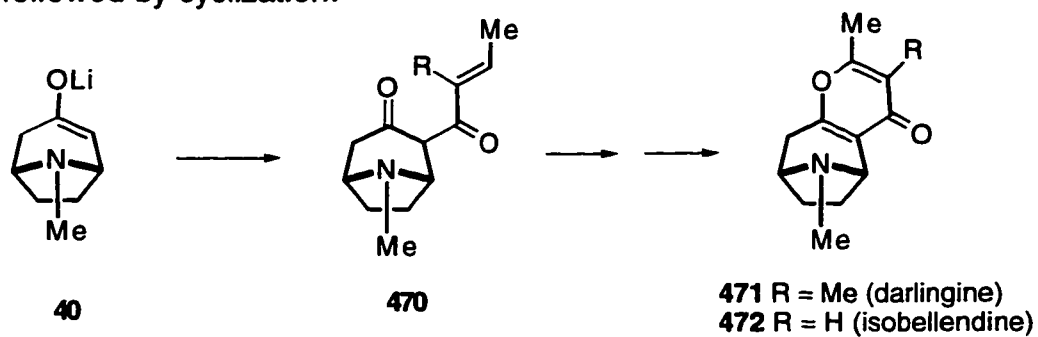

d) Knightinol available by *hydroxyalkylation*:

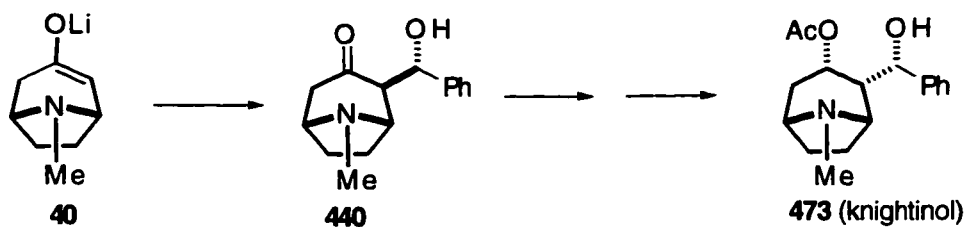

e) Alkaloid KD-B available by *alkylation*:

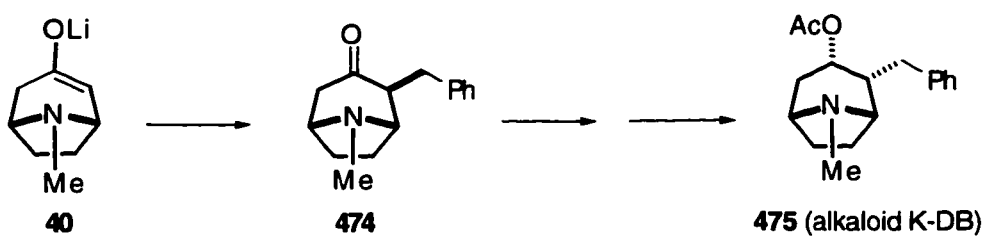

f) 6 β -Acetoxy-3 α -tigloyloxytropane available by *hydroxylation at position 6*:

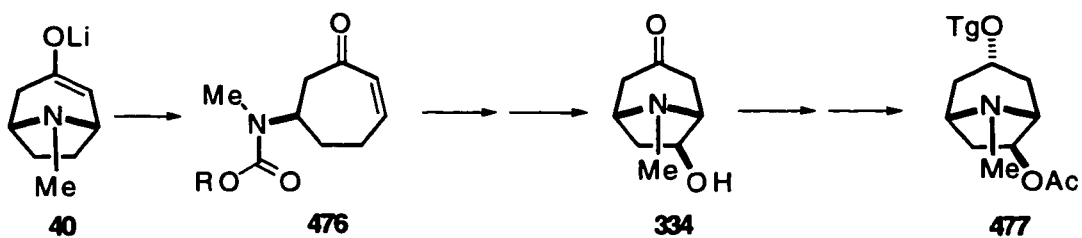

g) Physoperuvine available by *1,3-carbonyl transposition*:

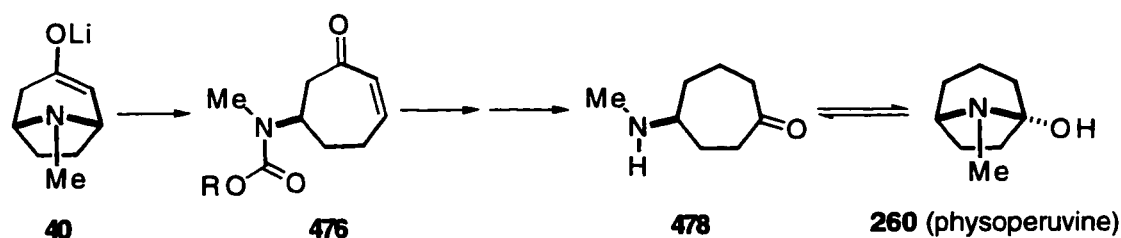

The successful preparation of these selected targets would also provide a method for correlation of their absolute configurations. Assignment of the absolute configuration of a natural product proves often challenging as shown by the example of valeroidine, the configuration of which was wrongly assigned on the basis of Hudson's rule.¹²² The revision of the absolute stereochemistry of this alkaloid was possible through a synthetic correlation with (*S*)-(-)-methoxysuccinic acid (derived from (*S*)-(-)-malic acid).¹⁴⁵ Tropane alkaloids whose absolute stereochemistry are known are listed in Table 2.12.

The most reliable methods for establishing absolute stereochemistry include direct X-ray analysis and chemical correlation with compounds of known stereochemistry. The EPC synthesis *via* enantioselective deprotonation of tropinone with chiral lithium amide base could provide a means for the correlation of the stereochemistry of asymmetrically substituted tropanes.

Table 2.12. Absolute stereochemistry of tropane alkaloids

Alkaloid	method of assignment
(-)-cocaine 50 and its analogs e.g. ecgonine	correlation with (L)-glutamic acid (ref 147, 101)
(-)-anhydroecgonine methyl ester 270	correlation with (-)-cocaine (ref 163)
(-)-valeroidine (-)- 131	correlation with (S)-(-)-malic acid (ref 145)
(-)-7 β ,3 α -ditigloyloxytropane 481	correlation with (S)-(-)-malic acid (ref 145)
7 β -tigloyloxy-3 α -hydroxytropane 482	correlation with (S)-(-)-malic acid (ref 145)
(+)-ferrugine (-)- 265	correlation with (-)-anhydroecgonine ethyl ester (ref 99)
(+)-ferruginine (-)- 328	correlation with (-)-anhydroecgonine ethyl ester (99)
(-)-calystegine A ₃ (-)- 325	enantioselective synthesis; CD and model of enzyme active site (ref 109)
(+)-calystegine B ₂ (+)- 290	correlation with (D)-glucopyranoside (ref 106)
(-)-baogongteng A (-)- 52	CD and ORD measurements (ref 175)
(+)-physoperuvine 260	X-ray analysis (ref 114c)

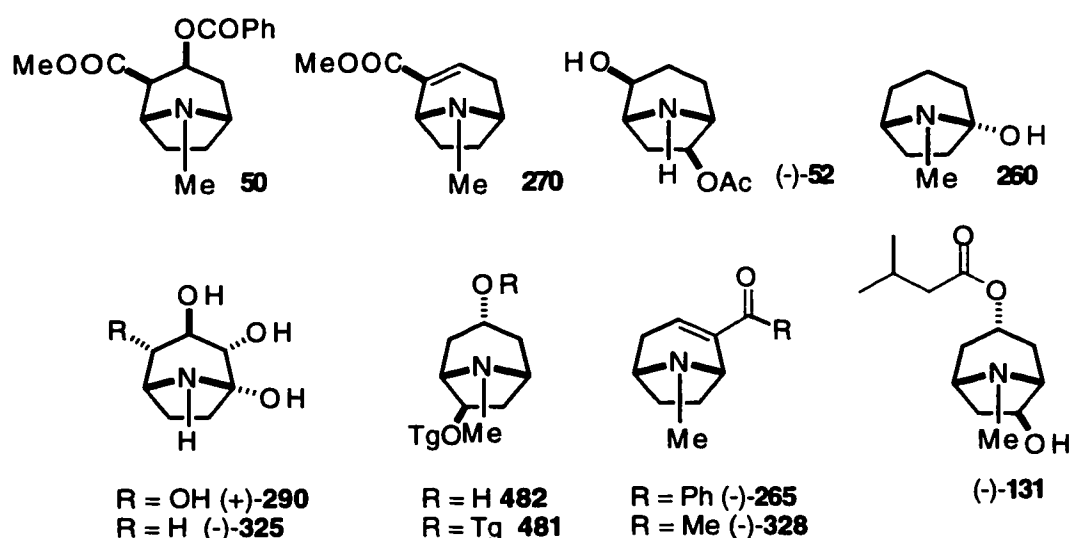

3.1. Alkoxy-carbonylation of tropinone enolate: Synthesis of anhydroecgonine methyl ester

Alkyl esters of anhydroecgonine could be prepared *via* sequence of reactions starting with alkoxy-carbonylation of tropinone enolate. Alkyl chloroformates are the obvious electrophilic reagents for introduction of alkoxy-carbonyl groups. Since the lithium enolate possesses three nucleophilic sites, one could envisage some difficulty with the regioselectivity of the reaction. The reaction of ethyl chloroformate with lithium tropinone enolate, however, was shown to occur unexpectedly and exclusively at the nitrogen site.¹¹⁻¹³ This reaction led to the opening of the five-membered ring of the tropane skeleton. I have found that the analogous reaction took place with all chloroformates which were tried i.e., methyl, benzyl, 2,2,2-trichloroethyl and menthyl chloroformate. Clearly, alkyl chloroformate was not a suitable reagent for introduction of methoxycarbonyl group at C-2 of the tropane system.

Scheme 78

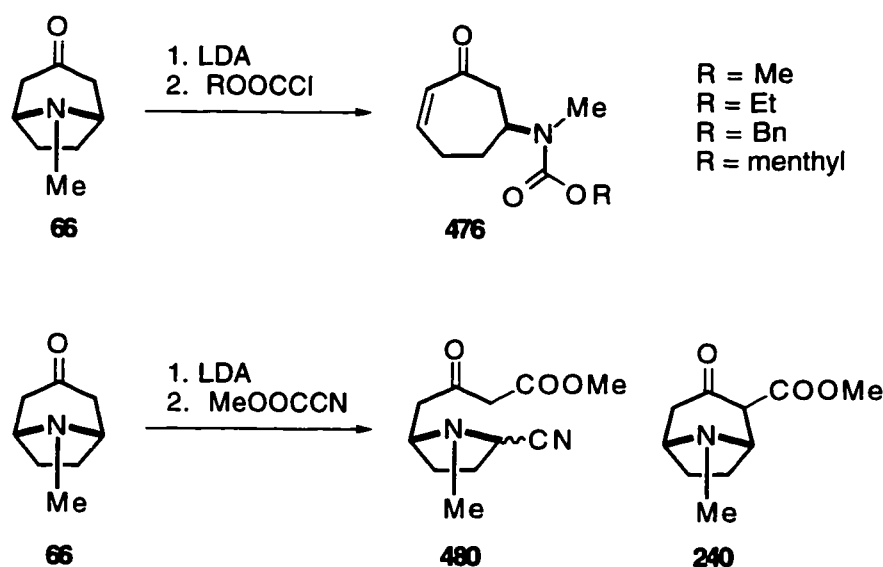

Mander and Sethi developed methyl cyanofornate as a very effective reagent for α -methoxycarbonylation of ketones.¹⁹ Zheng observed though that the reaction of tropinone lithium enolate with this reagent led to the formation of a substantial amount of the unexpected product **480**,¹¹ which was probably formed during the workup as a result of the reaction of the product of methoxycarbonylation with the cyanide ion. Silver salts were used during workup in order to scavenge the released cyanide ions and thus prevent (or reverse) the side reaction.¹³ I have applied this procedure, with slight modifications, to methoxycarbonylation of nonracemic tropinone lithium enolate prepared by the deprotonation of tropinone with a 2:1 mixture of the chiral lithium amide **450 a** and LiCl. This reaction gave methoxycarbonyltropinone **240** in 92% ee and 89% yield. The scalemic methoxycarbonyl tropinone was diastereoselectively reduced to allopseudoecgonine methyl ester **483** under conditions developed by Keagle and Hartung.⁵⁰ Elimination of H₂O under mild conditions finished the enantioselective synthesis of *ent*-anhydroecgonine methyl ester **485** (Scheme 79).

The intermediate **240** was used in the syntheses of cocaine and its isomers (cf. Chapter I). Thus, the preparation of the β -ketoester **240** in high optical purity opens a route to the enantioselective synthesis of cocaine and related natural products.

Scheme 79

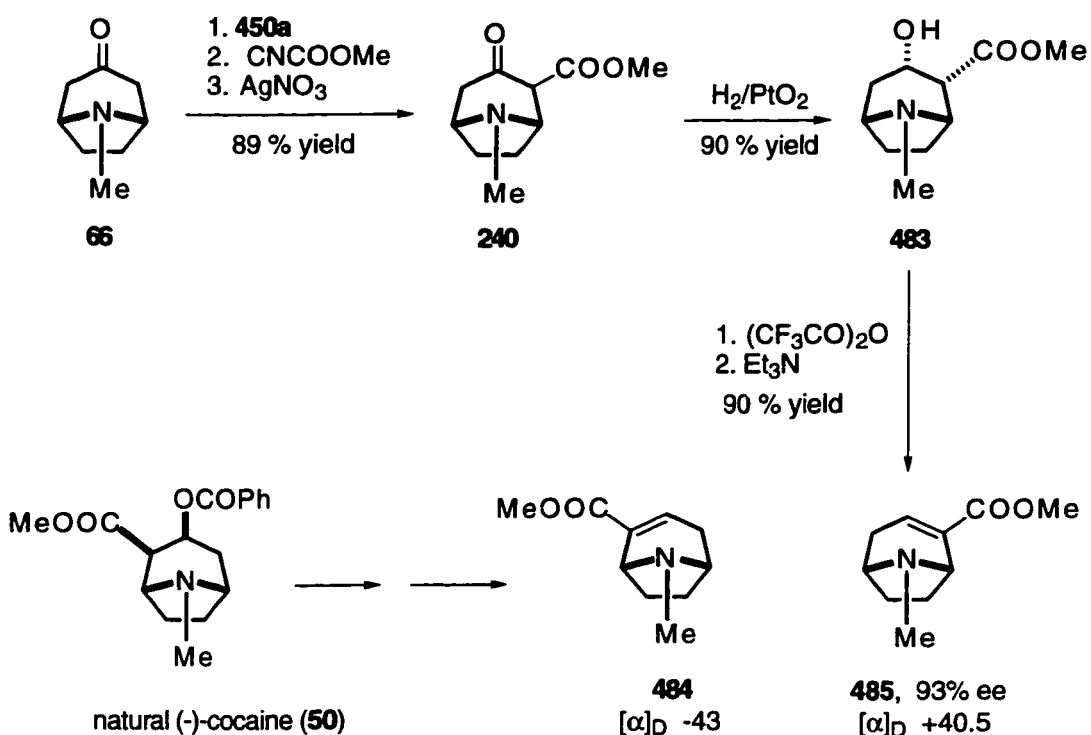

Absolute Stereochemistry of Deprotonation

In order to establish the absolute stereochemistry of deprotonation of tropinone with chiral lithium amides it was necessary to correlate the configuration of synthetic alkaloids with compounds of known configuration. Cocaine is one of the few tropane alkaloids the absolute configuration of which was positively established.¹⁴⁷ Anhydroecgonine methyl ester is synthetically related to cocaine and can be prepared from natural (-)-cocaine with retention of the absolute stereochemistry.¹⁶³ Thus, a comparison of the signs of optical rotation of the synthetic product **485** and the product prepared from (-)-cocaine (**50**) allows for determination of the absolute stereochemistry of deprotonation of tropinone with the chiral amide **450a**.

Data in Scheme 79 indicate that the synthetic (+)-methyl ester **485** has the absolute configuration opposite to (–)-cocaine, and that the bidentate amide **450a** attacks tropinone preferentially at the *exo pro-S* hydrogen. This establishes the absolute stereochemistry of deprotonation with other chiral lithium amides used before in our methodological studies, because of the known relative position of the minor and the major enantiomer peaks observed in the NMR and the HPLC analyses of enantiomeric excess (Table 2.13). This, in turn, provides a means of assignment of the absolute stereochemistry of all of the synthetic products prepared by the enantioselective deprotonation of tropinone.

Table 2.13. Absolute stereochemistry of deprotonation of tropinone with chiral lithium amides

Li amides preferentially attacking <i>pro-R</i> hydrogen	Li amides preferentially attacking <i>pro-S</i> hydrogen
R-447	R-447
R-441	R-448
R-446	R-449
S-445	R-450
S-462	S-441
R-442	S-444

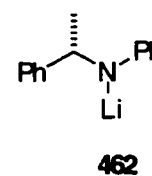
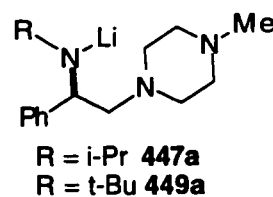
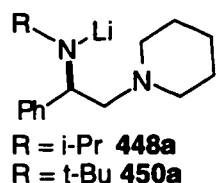
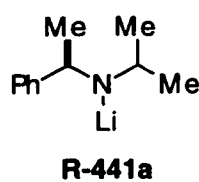
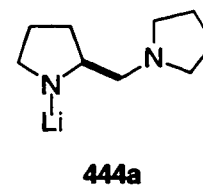
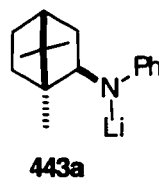
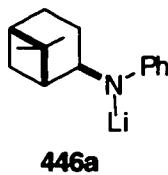
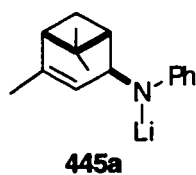
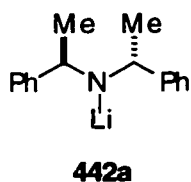

The absolute configurations of natural products, which are accessible by enantioselective deprotonation with amides **447a-450a**, could be inferred from a simple comparison of the optical rotations of the natural and synthetic products.

3.2. Acylation of tropinone enolate: Synthesis of chalcostrobamine and pyranotropanes

Acylation of tropinone lithium enolate offers a very simple approach to the synthesis of several tropane alkaloids. Acylation with acyl chlorides was used in the past in a rather inefficient synthesis of two pyranotropanes (cf., chapter I). In my hands, an attempted acylation of tropinone lithium enolate with crotonyl chloride resulted in a very unclean reaction. The only isolated product **486** turned out to be the result of a reaction at nitrogen, analogous to the previously observed products of reaction with chloroformates (Scheme 80).

Scheme 80

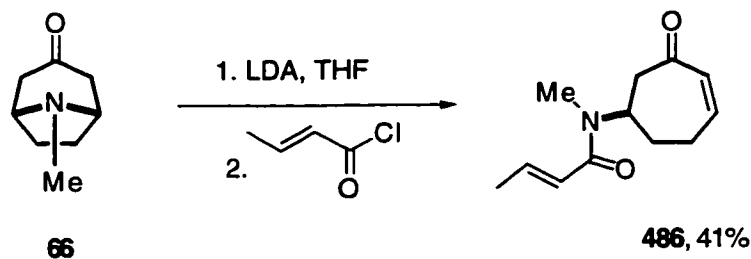

An alternative to acyl chlorides as acylating reagents are acyl cyanides. Several acyl cyanides were prepared by the reaction of acyl chlorides with copper (I) cyanide in acetonitrile according to the procedures by Hoffmann and Normant (Scheme 81).^{171,172}

Scheme 81

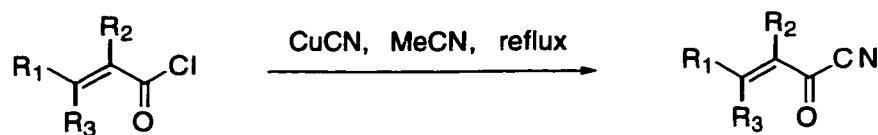

487a: $R_1 = \text{Me}, R_2 = \text{Me}, R_3 = \text{H}$

487b: $R_1 = \text{Me}, R_2 = \text{H}, R_3 = \text{Me}$

487c: $R_1 = \text{Me}, R_2 = \text{H}, R_3 = \text{H}$

487d: $R_1 = \text{Ph}, R_2 = \text{H}, R_3 = \text{H}$

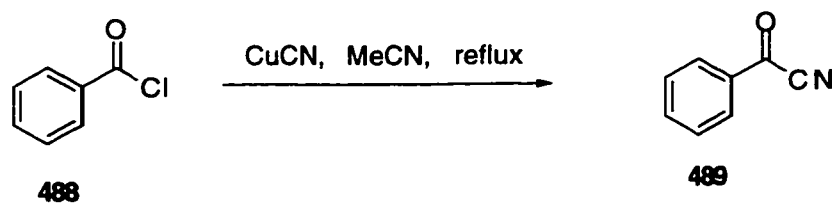

The cyanides **487a-487d** proved very effective and regioselective acylating agents. Reactions with racemic tropinone lithium enolate were clean and gave high yields of β -diketones **490a-490d** (Scheme 82). The β -diketones **490a-490c** underwent base-catalyzed cyclization to dihydropyranotropanes **491a-c** which were isolated as mixtures of diastereoisomers. Diastereoselectivity of these cyclizations was low and ranged from 2:3 to 1:2.

Scheme 82

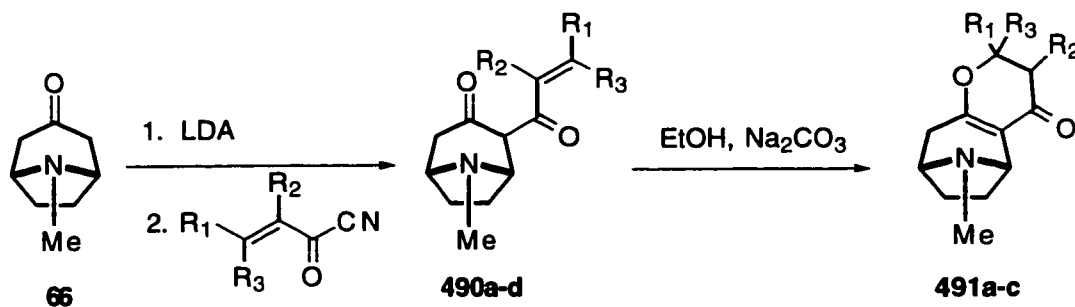

The cinnamoyltropinone **490d**, obtained in 75% yield as a yellowish oil was identical with racemic chalcostrobamine.⁸⁹ When the chiral lithium amide was used instead of LDA for the generation of the enolate the reaction resulted in the optically active chalcostrobamine. Two protocols for enantioselective deprotonation of tropinone, developed during the methodological studies, were applied to obtain both enantiomers of the alkaloid. When the bidentate amide **450a** (used as a mixture with 0.5 equivalent of LiCl) was used the synthesis resulted in *ent*-chalcostrobamine in 95% ee (Scheme 83). On the other hand, when the novel protocol for the *in situ* generation of the amide-LiCl mixture (**R-442a**/LiCl), by addition of 2 equivalents of *n*-BuLi to the chiral amine hydrochloride was used, the synthesis gave natural chalcostrobamine in 92% ee (Scheme 83).

Scheme 83

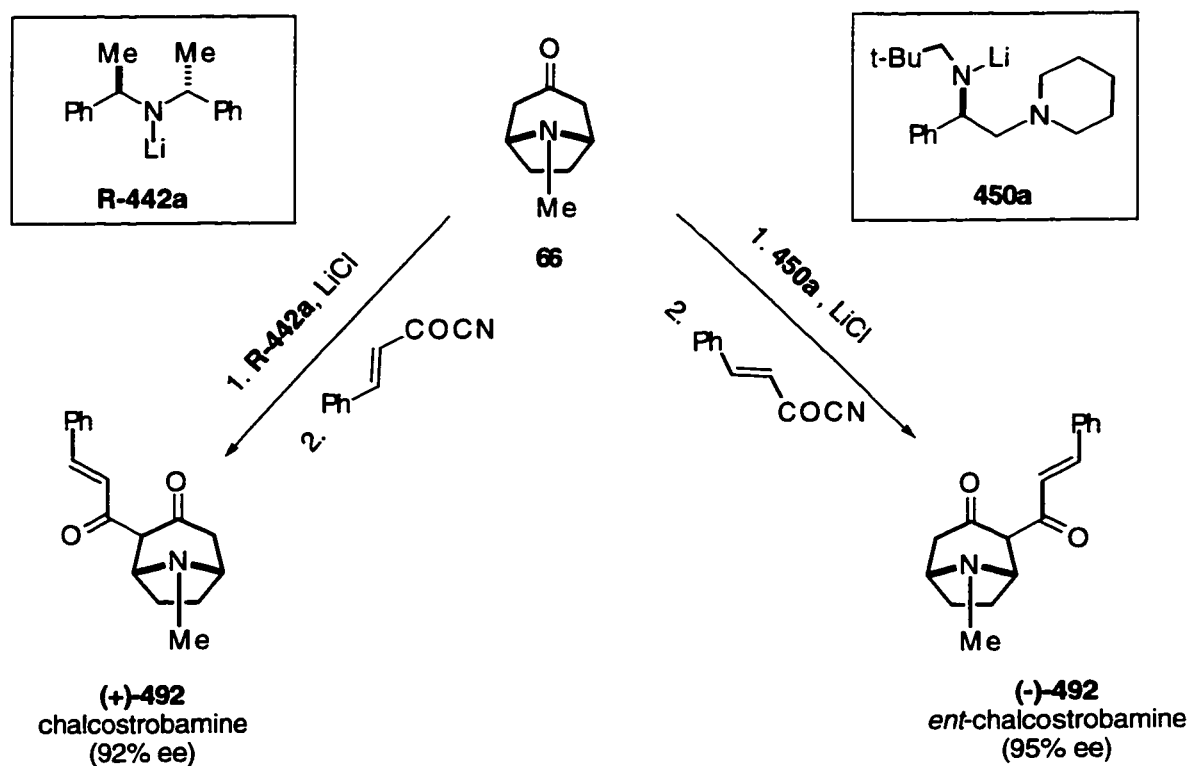

The nonracemic tropinone enolate was treated with tigloyl cyanide (**487a**) or crotonyl cyanide (**487c**) and the crude products were subjected to cyclization (Scheme 84). The chromatographic separation gave the product as a mixture of isomers and the recovered chiral amine which could be purified and reused. Formation of the pyranotropane system required introduction of an additional C=C bond to compounds **491a** and **491c**. In the case of compound **491a**, bromination at the α position and elimination of HBr was successful. The resulting alkaloid (53% yield from tropinone) was identical in all respects, except the sign of optical rotation with natural darlingine (Scheme 84).¹⁶¹

Scheme 84

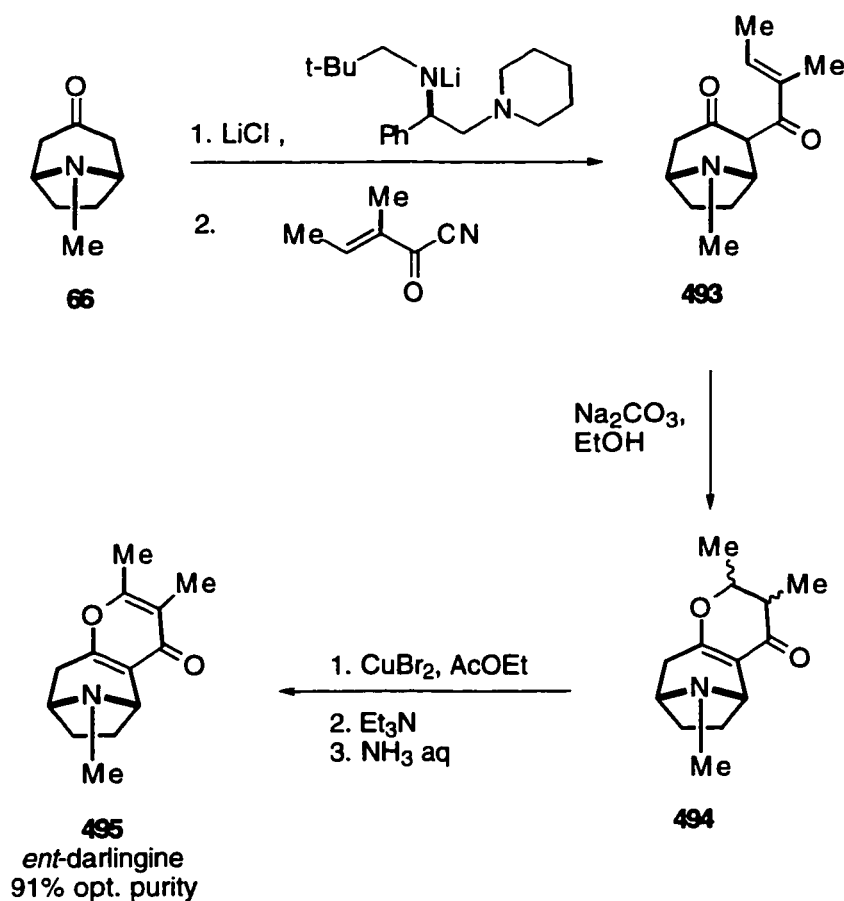

Since I could not find a reliable method of ee measurement for *ent*-darlingine, optical purity of this compound was estimated through comparison with a sample of natural darlingine provided by Prof. Bick. It turned out to be 91%, which is comparable with the purity of the other alkaloid products prepared *via* the same protocol.

A similar sequence of transformations as shown in Scheme 84 was hoped to provide isobellendine (**500**), *via* acylation of tropinone enolate with crotonyl cyanide. Unexpectedly, the bromination/dehydrobromination sequence turned out to be troublesome. All other attempts to introduce the double bond into compound **491c** through either bromination or selenoxide fragmentation failed. I decided to prepare a functionalized cyanide (**496** or **497**), which was expected to serve as a synthetic equivalent of the alkynoyl cyanide.

Scheme 85

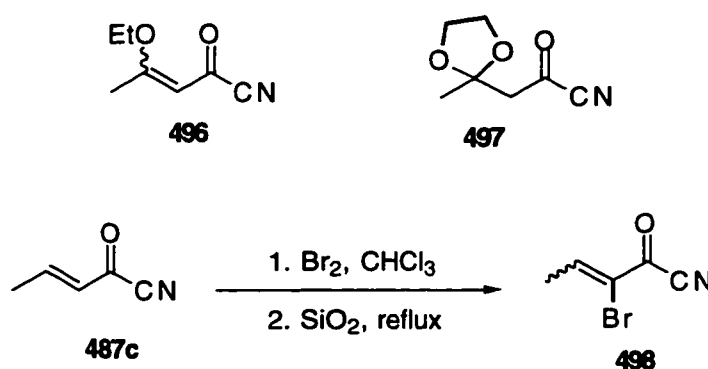

Preparation of cyanides **496** and **497**, was difficult, due to the poor stability of the protecting groups under acidic conditions. Eventually, I made the cyanide **498** by the addition of bromine to crotonyl cyanide followed by elimination of HBr. As shown in Scheme 86 this reagent was satisfactory for the synthesis of isobellendine (**500**). The crude product of acylation **499** was refluxed with

triethylamine which caused the cyclization with concomitant elimination of HBr. The chromatographic purification of the resulting mixture gave the recovered chiral amine **450** and a levorotatory product (92% ee by NMR) which had spectral data identical with natural isobellendine.⁸⁷ Since the natural isomer is dextrorotatory the synthesis had to produce *ent*-Isobellendine (45% overall yield from tropinone).

Scheme 86

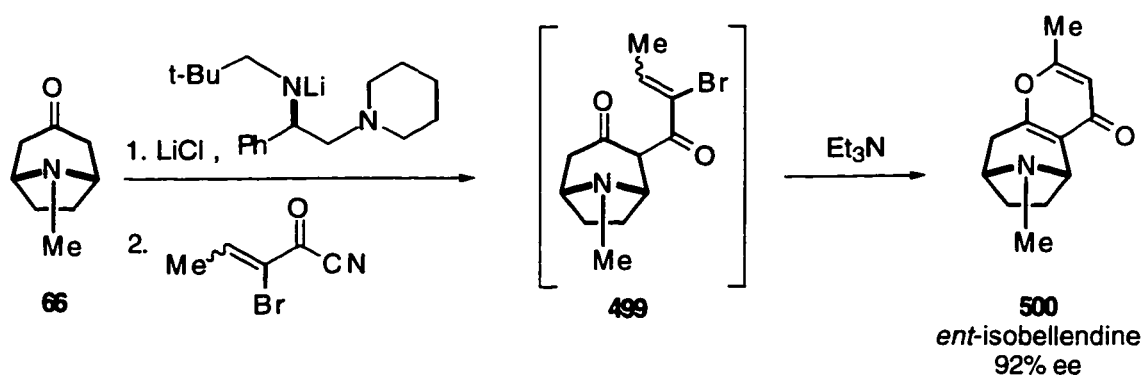

Thus, the syntheses presented above demonstrated that acylation of the scalemic tropinone lithium enolate is an excellent and general approach to EPC synthesis of acyltropanes (e.g., chalcostrobamine) and pyranotropanes. The EPC syntheses established the absolute configurations of chalcostrobamine, darlingine and isobellendine. The specific rotation data indicated that the natural enantiomers of these alkaloids have the acyl chain originating at C-2 and not at C-4 as arbitrarily shown in the literature.³³ A previously unknown dihydropyranotropane (–)-**491b** was also prepared in good yield and with high enantioselectivity (93% ee).

3.3. Hydroxybenzylation of tropinone enolate: Synthesis of knightinol

In order to show the practical significance of the aldol reaction between the tropinone enolate and benzaldehyde, I decided to synthesize knightinol (**557**). Since knightinol (**557**) and the aldol **552** (Scheme 87) have the opposite configuration on the carbon atom bearing the hydroxybenzyl group (*endo* and *exo* respectively), the configuration of this center of the aldol **552** had to be inverted. In order to obtain the usually more stable *endo* isomer of the aldol **552**, the OH group of the hydroxybenzyl moiety had to be protected. Otherwise, the hydrogen bonding between the OH and the amine nitrogen atom¹⁷³ would make the *exo* isomer more stable. The most successful protecting agents were TBDMS-Cl and TMS-CN. However, the TMS derivative was unstable to silica gel and was not used. Equilibration of the TBDMS derivative of the aldol under basic (Na₂CO₃, t-BuOK, EtONa) and acidic (SiO₂) conditions was studied and found unsatisfactory. However, a slight difference in the ratio of the isomers was observed after separation of the mixture of *endo* and *exo* isomers (produced from the equilibration in the presence of SiO₂) by flash chromatography.

Scheme 87

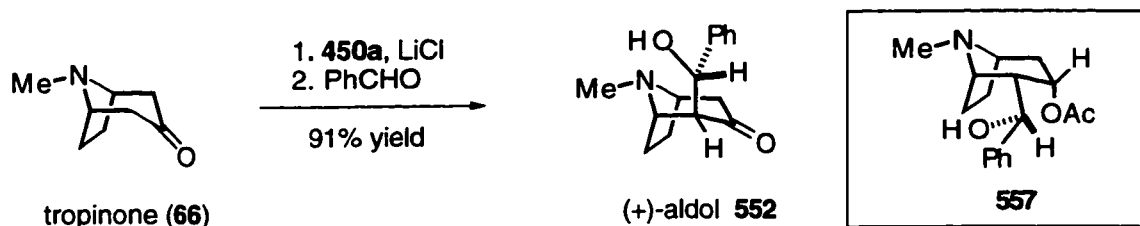

Scheme 88

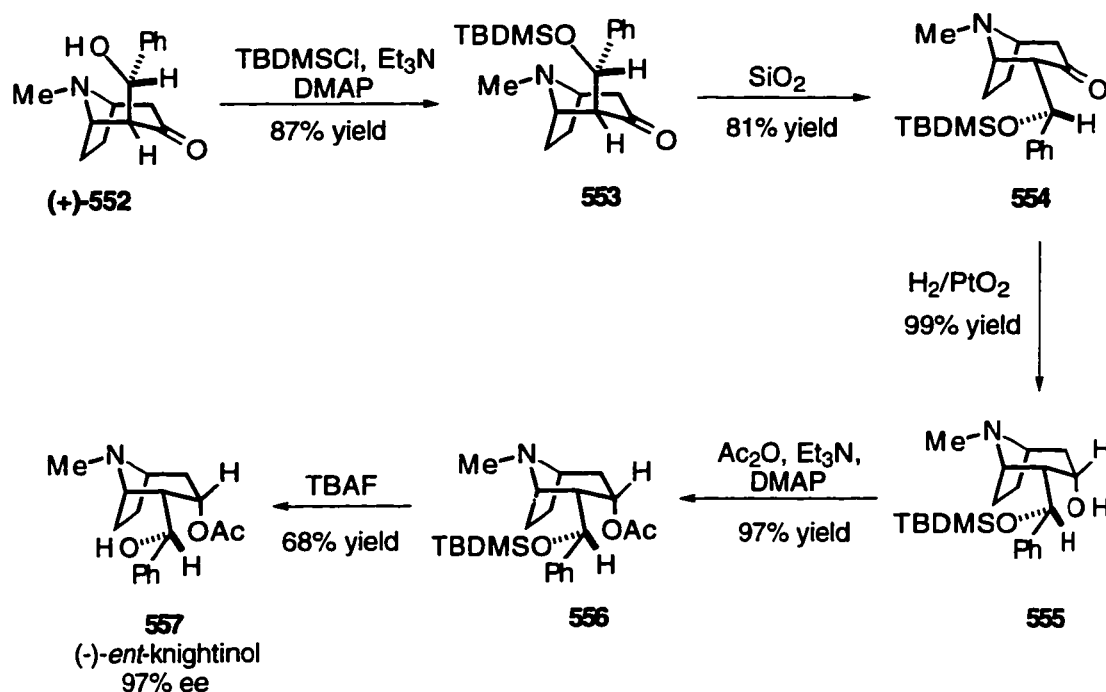

After experimenting with solvent and reaction time it was found that elution of a flash silica gel column on which the TBDMS protected aldol was left for 12-18 h, produced mostly the desired *endo* isomer. When the time of equilibration on silica column was extended over 18 h decomposition was observed, resulting in a lower material recovery. Hydrogenation on PtO₂ turned out to be the best method of stereoselective reduction of the carbonyl group in the equilibrated product **554**. Acetylation of the secondary alcohol **555**, and deprotection of the OH group in the side chain under standard conditions gave product **557** which was identical (NMR) with the sample of natural knightinol provided by Prof. Lounasmaa. Optical rotation of the synthetic product was, however, opposite. The relative configuration of the aldol **552** was established before by X-ray crystallography.¹⁷³ Thus, the synthesis establishes both the absolute

and the relative configuration of knightinol through correlation with the aldol **552** (Scheme 88).

3.4. Alkylation of tropinone enolate: Synthesis of Alkaloid KD-B.

Alkaloid KD-B (**562**) could, theoretically, be prepared by benzylation of tropinone enolate prepared from tropinone (Scheme 89). However, numerous attempts to alkylate tropinone lithium enolate directly with benzyl bromide were not successful and resulted in the formation of complex mixtures of products. Unexpectedly an alternative emerged. During the search for the best protecting group for the hydroxyl group of the aldol **552** I have prepared the acetyl derivative **558** (Scheme 90), which proved to be very unstable, especially in the presence of SiO_2 . Any attempt to purify this acetate on a silica column resulted in a complete elimination to the unsaturated ketone **559**. The structure of the elimination product was in agreement with the literature data.^{91a} I decided to take advantage of the fact that such elimination could be combined with hydrogenation of the enone **559**, and would provide an indirect way of enantioselective benzylation of tropinone. Enone **550** was hydrogenated over PtO_2 to provide the *endo* alcohol **560** which, after acetylation, gave acetoxybenzyltropane **562**, known as alkaloid KD-B.⁹¹

Scheme 89

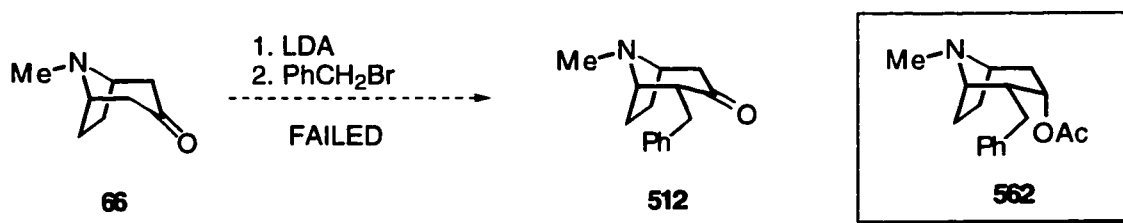

The alkaloid isolated from plants was described as a racemate. The synthetic alkaloid had the absolute configuration shown on Scheme 90 and was levorotatory in chloroform solution. The product of benzylation of tropinone **512** was also obtained by simple hydrogenation of enone **559** with palladium as the catalyst.

Scheme 90

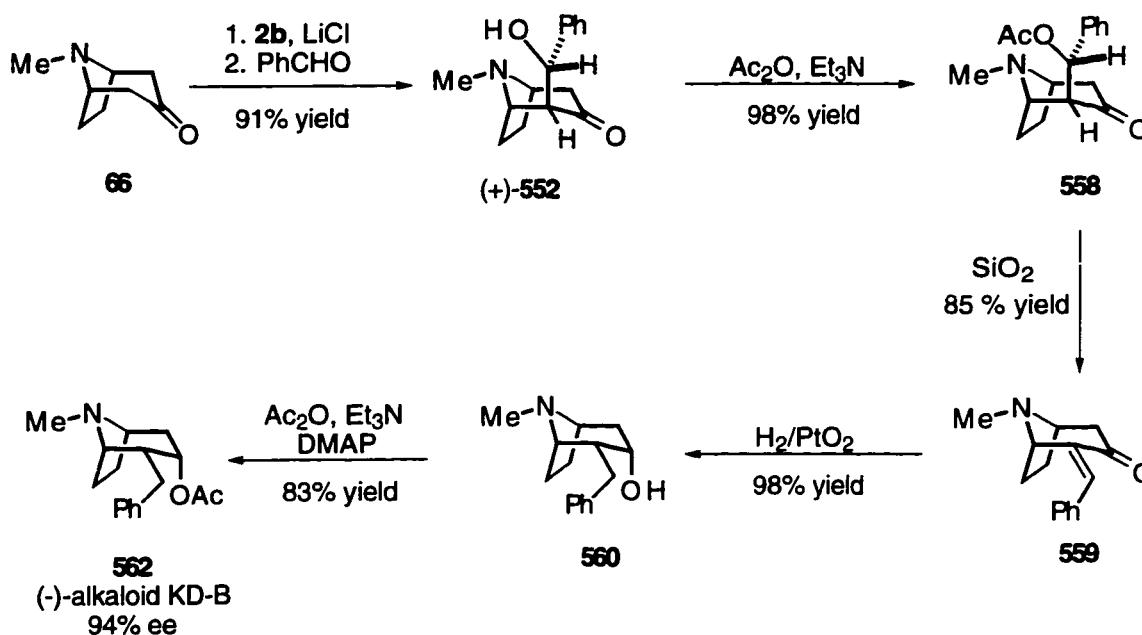

3.5. Introduction of the OH group at C-6 or C-7 of the tropane system: Synthesis of 7β-acetoxy-3α-tigloyloxytropane and 3α,6β-diacetytropane

In order to address the problem of the enantioselective synthesis of 6-hydroxytropane derivatives (e.g.: 3α,6β-diacetytropane or 6β-acetoxy-3α-tigloyloxytropane) I have concentrated my efforts on functionalization of the allylic position of product **565** resulting from the reaction of tropinone lithium enolate with chloroformates. All attempts to functionalize ketone **565**

(protected as acetal) through oxidation or bromination of the allylic position failed (Scheme 92).

Scheme 91

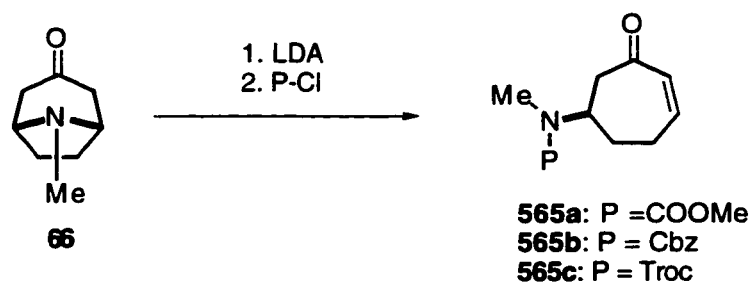

Another way by which one could approach a synthesis of 6-hydroxytropane derivatives was reduction of the enone to the allylic alcohol, followed by an allylic oxidation (Scheme 93).

Scheme 92

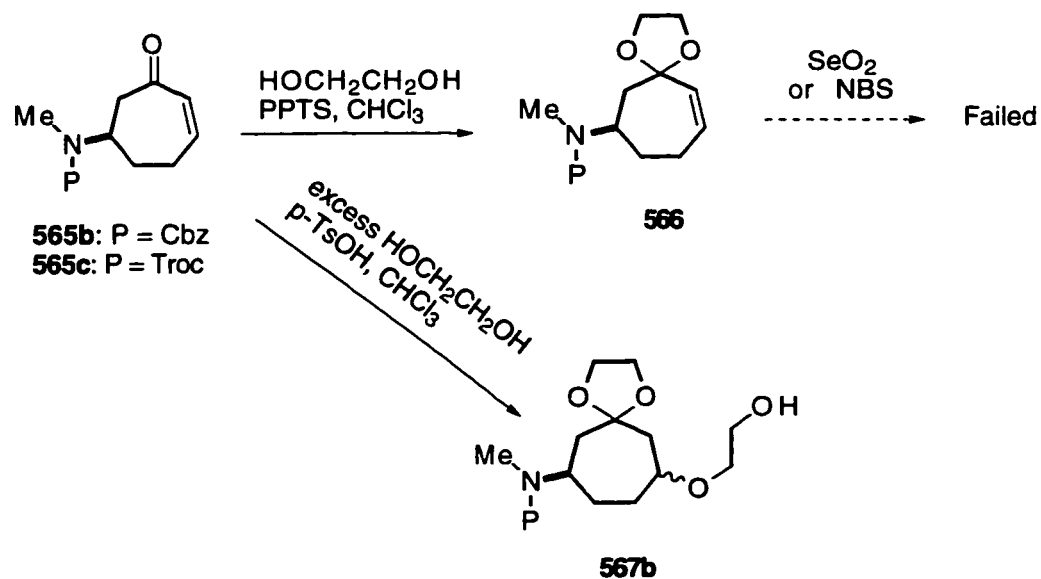

Scheme 93

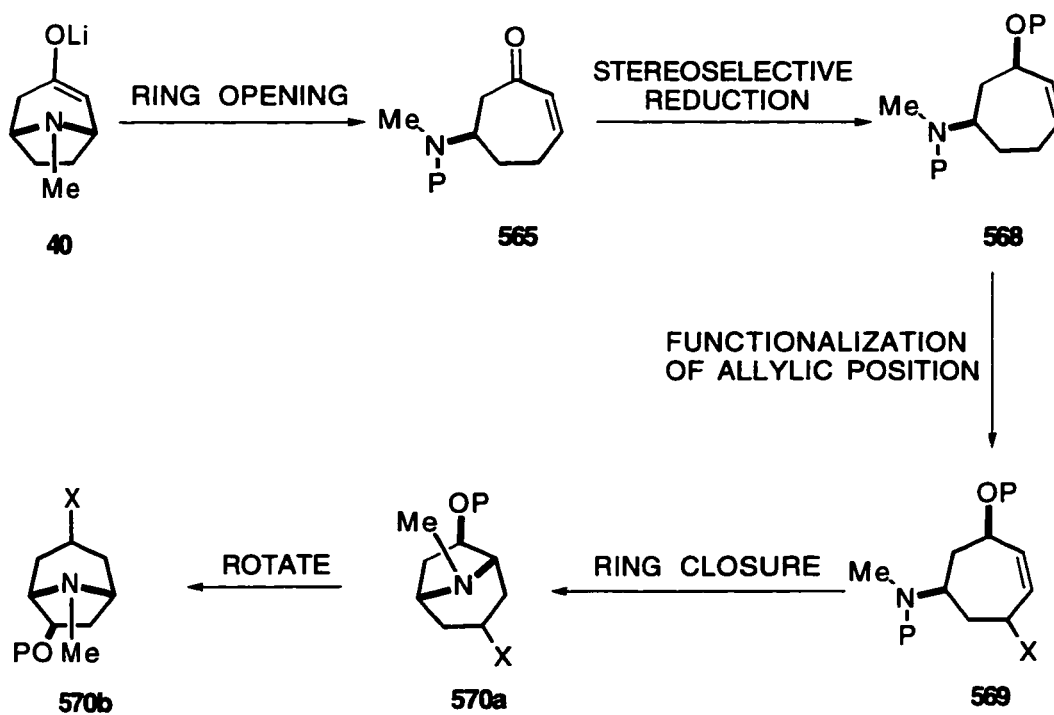

Scheme 94

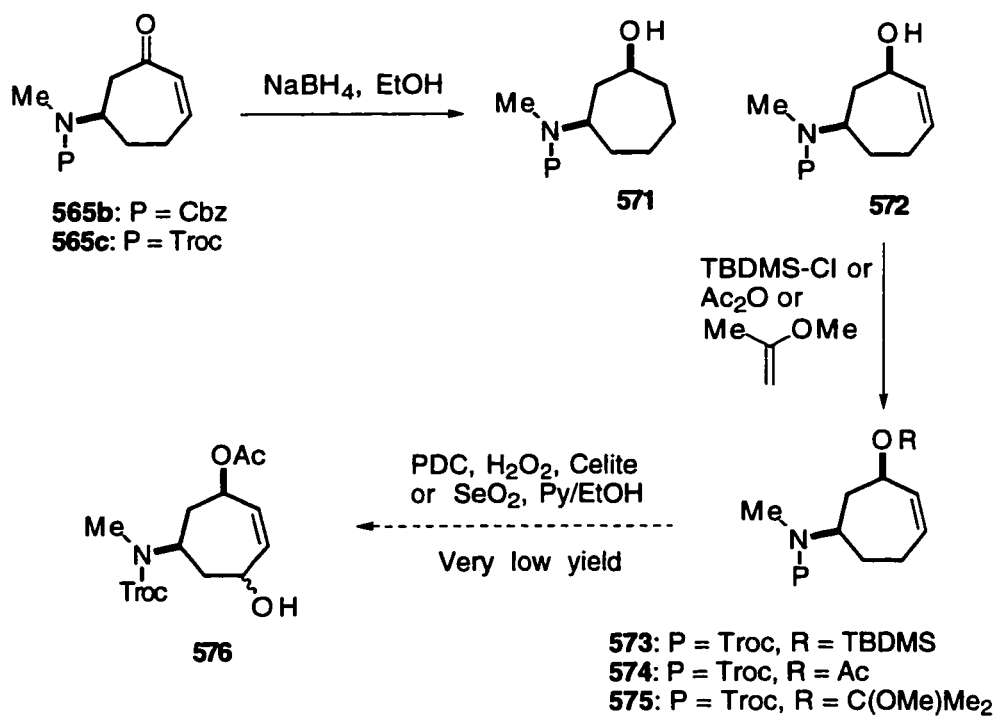

If the reduction was stereoselective and gave the *cis* isomer, one could expect a significant shortening of the synthetic sequence. The allylic hydroxy group would become 7-*exo* OH after the ring closure in **569**.

When this approach was attempted, the first problem which emerged was 1,4-reduction of the enone **565** (P = Cbz or Troc, Scheme 94). This was readily solved by application of the Luche method ($\text{CeCl}_3/\text{NaBH}_4$).¹⁷⁰ The allylic alcohol product **572** had to be protected before the oxidation was attempted. Several OH protecting groups (e.g., 2-methoxyisopropyl, TBDMS) were tried but failed to provide sufficient protection under typical allylic oxidation conditions (*t*-BuOOH/PDC and SeO_2 or SeO_2/Py). Acetate **574**, which could lead directly to 7-acetoxy alkaloids, was stable under these conditions. Another serious problem, however, was that none of the above mentioned oxidants was effective enough. The best results were obtained with H_2SeO_3 in wet dioxane, but the reaction did not reach conversion better than 15% and produced a complex mixture of three oxidation products (two isomeric alcohols **576** and the enone **577**) and several unidentified byproducts (Scheme 95). Increasing the reaction time, using an excess of the oxidant or adding the selenium reagent in small portions over a long time, did not improve the effectiveness of this process. During this reaction a substantial amount of selenium was produced in the form of a suspension. I tried scavenging the colloidal selenium by Celite in hope of increasing the reaction yield. Indeed, the conversion of the starting material was dependent on the amount of added Celite.

Scheme 95

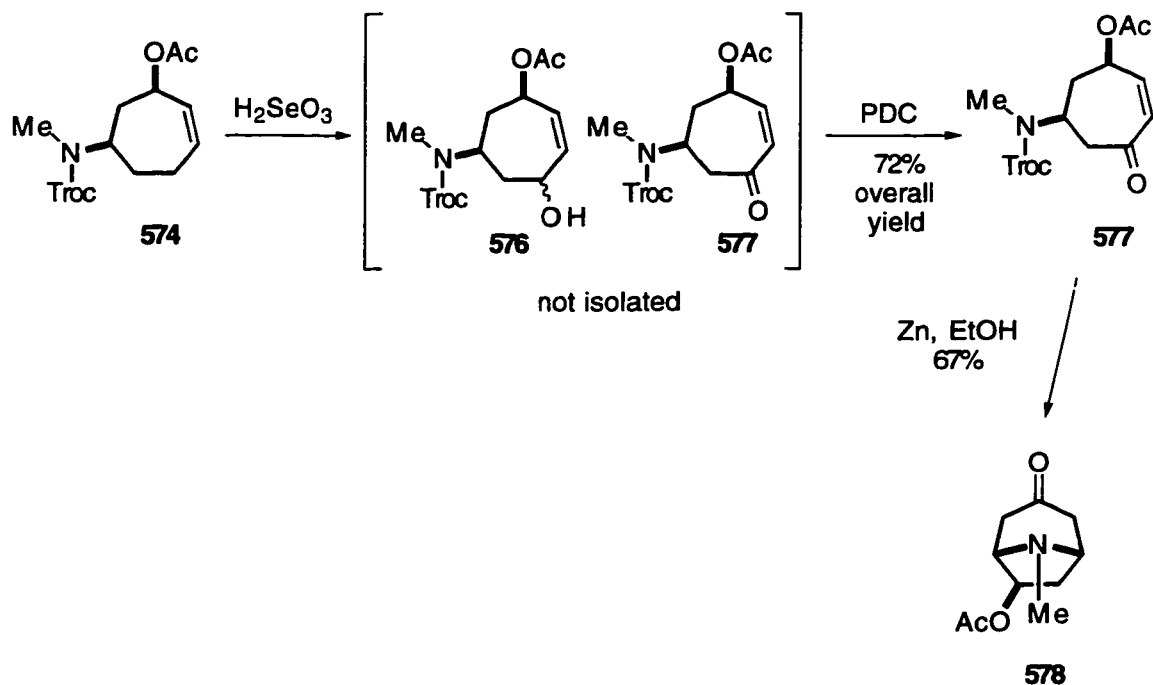

Another technical problem was the difficulty in removing the selenoorganic impurities. Purification of the recovered starting material and of the products from the selenoorganic byproducts called for an oxidative workup. Since the next step in the synthesis would be oxidation (PDC) of the two isomeric allylic alcohols to the enone **577**, I decided to combine these steps in one procedure. Thus, the transformation of the acetate **574** to the enone **577** was accomplished in 72% yield (corrected for recovered starting material; Scheme 95). I have observed earlier that deprotection of the 2,2,2-trichloroethylcarbamate group in enone **565c**, with zinc in ethanol led to tropinone in almost quantitative yield. When the enone **577** was subjected to the same conditions the racemic 6-acetoxytropinone **578** was formed (Scheme 95).

The enantioselective synthesis of 7 β -acetoxytropinone **585** is shown on Scheme 96. The ring opening was accomplished with the C_2 symmetric chiral

lithium amide/LiCl mixture. The rest of the synthesis follows the paths previously worked out on the racemate.

Scheme 96

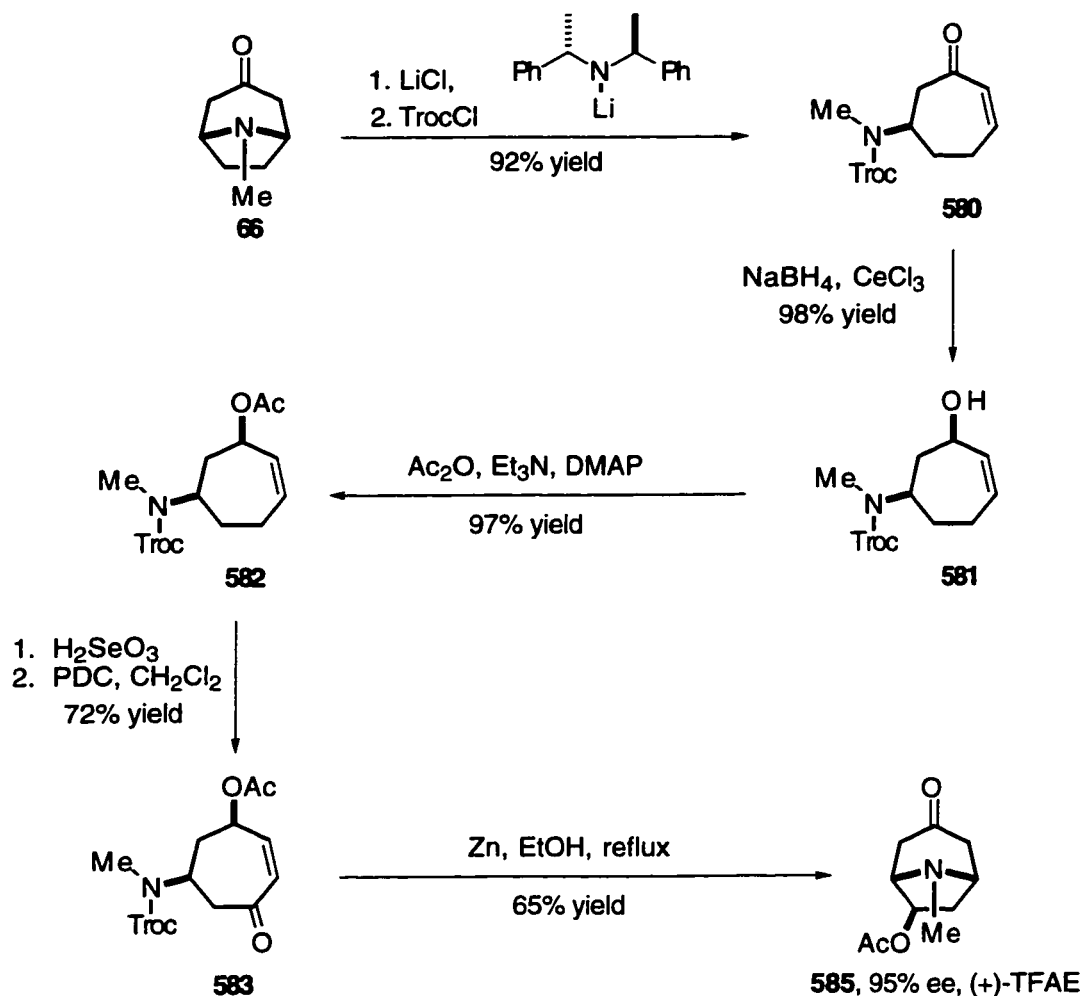

The scalemic 7β-acetoxytropinone **585** served as the key intermediate in the preparation of two optically active tropane alkaloids: (+)-3α,7β-diacetoxytropane (**587**) and (-)-7β-acetoxy-3α-tigloyloxytropane (**588**) (Scheme 97). The stereoselective reduction of the carbonyl group in **585** was achieved, as previously, by hydrogenation on a PtO₂ catalyst.

Scheme 97

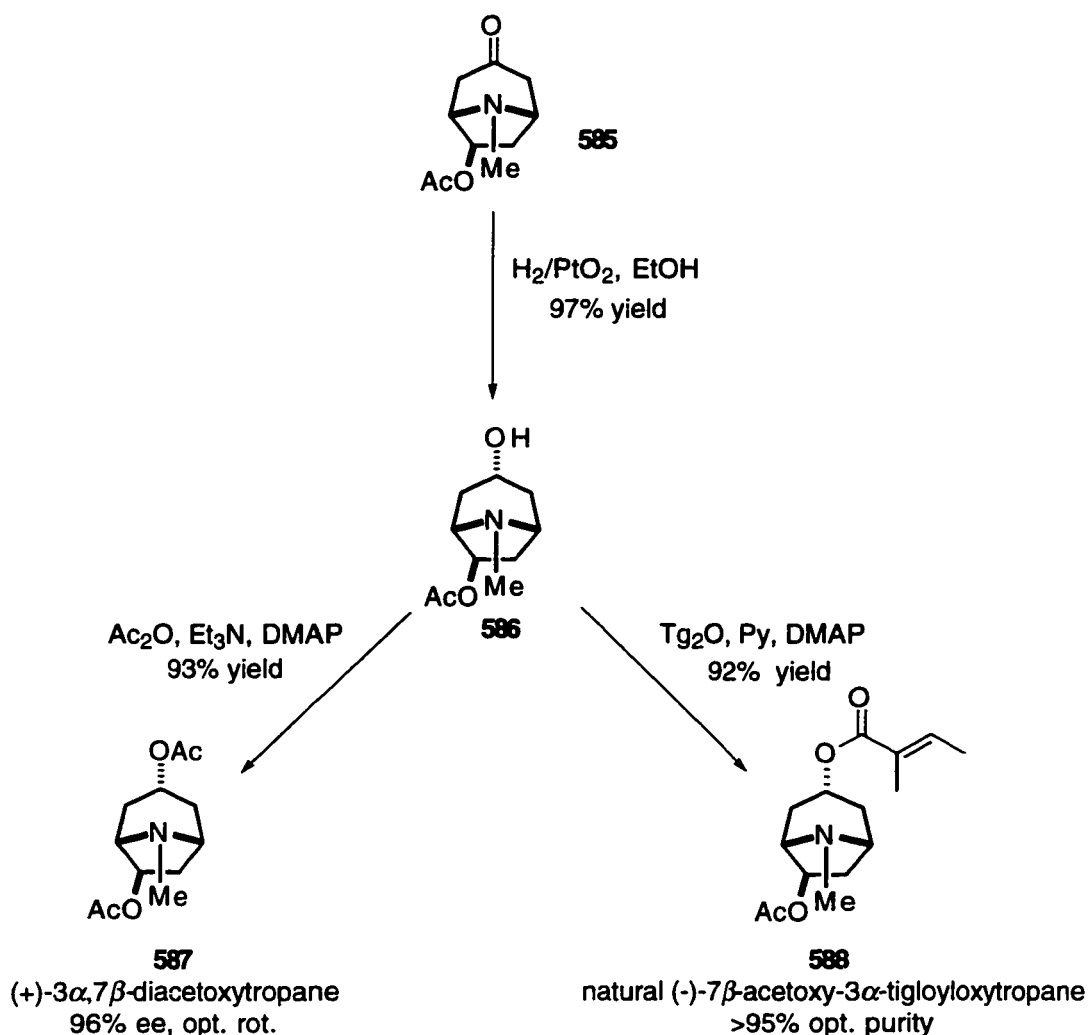

3.6. 1,3-Carbonyl transposition: Synthesis of physoperuvine

The ring opening reaction leading to **565** was applied to the synthesis of the hydroxy-tropane alkaloid physoperuvine. During an attempted basic hydrolysis of the carbamate protecting group of **565**, I have observed that conjugate addition of methanol to form the enone **589** was extremely facile. In order to take advantage of that fact, and accomplish a 1,3-transposition of the C=O a sequence of reactions was envisaged as follows: addition of benzyl alcohol to the enone, reduction of the ketone, mesylation of the alcohol **590**,

and hydrogenolysis of the benzyl group followed by the oxidation and elimination to the enone **592** (Scheme 98).

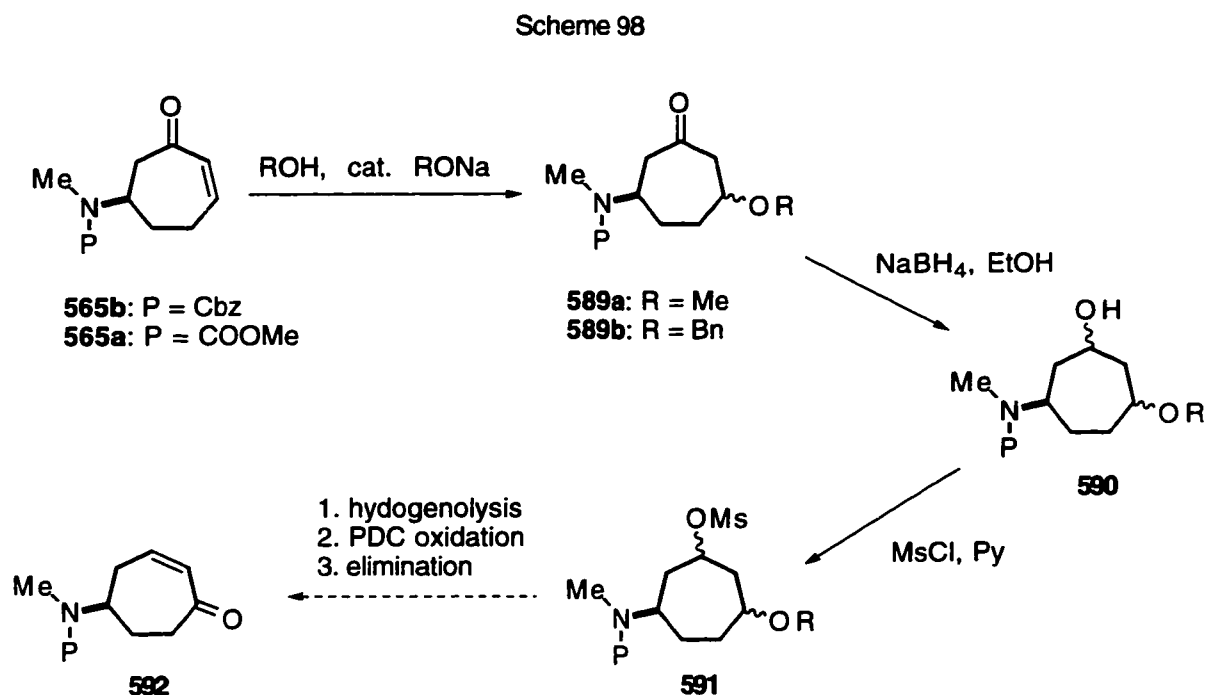

Since this transformation would require 6 steps, other options were considered at the same time. The alternative transformation based on the Wharton rearrangement¹⁶⁹ was tested on a model compound **594** and proved successful (Scheme 99). When the epoxide **594**, prepared by epoxidation of the enone **565a**, was treated with hydrazine at room temperature evolution of nitrogen gas was observed. The products (2 isomers with similar R_f's) of this reaction were isolated and treated with PDC; one UV absorbing compound was obtained. The ¹H-NMR spectrum of this product was very similar to the spectrum of the enone **565a**, however, a close examination of the spectra showed small differences in chemical shifts of the vinylic hydrogens, indicating that the two enones, **565a** and **596**, were regioisomers. Thus, the Wharton rearrangement offered a shorter route for the 1,3-transposition of C=O group.

Scheme 99

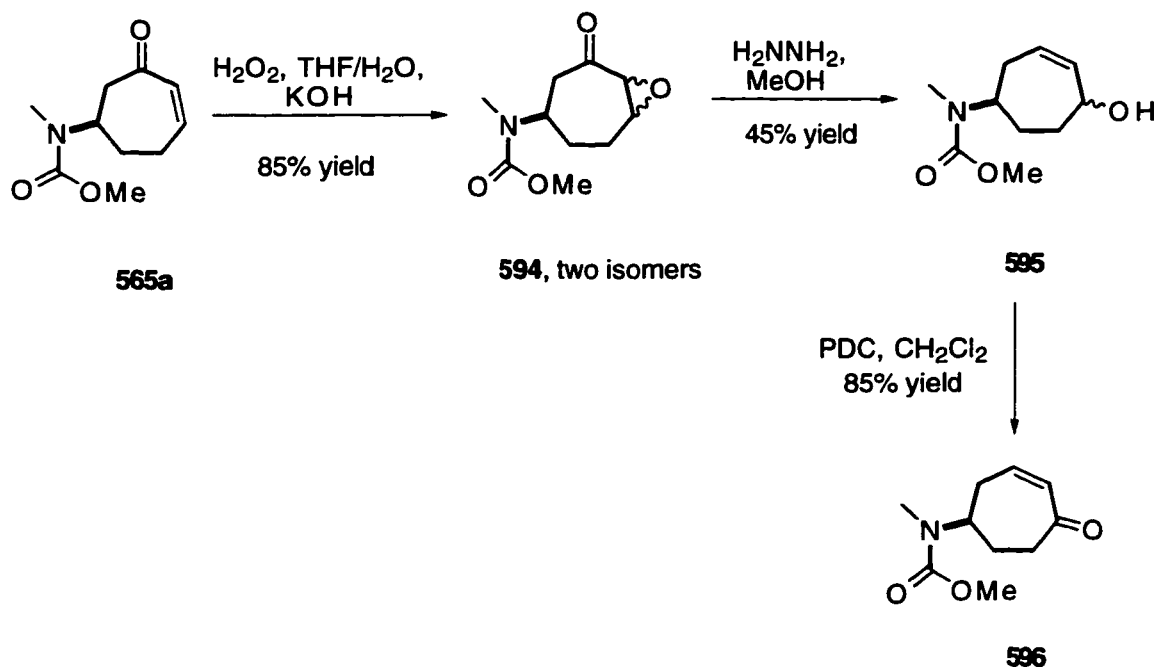

The procedure for a 1,3-transposition of the carbonyl group *via* the Wharton rearrangement was applied to the EPC synthesis of physoperuvine. The scalemic enone **597** was prepared by enantioselective deprotonation with the chiral lithium amide/lithium chloride mixture prepared from the hydrochloride of the amine **S-442**. Although methanol is typically used as the solvent for epoxidation of enones, aqueous THF had to be used in the preparation of epoxides **598** and **594** to avoid the competing conjugate addition of the solvent to the enone. The Wharton rearrangement was done by treatment of the mixture of isomeric epoxides with hydrazine and a catalytic amount of acetic acid. The rearranged allylic alcohol **599** was easily oxidized to the corresponding enone **600**. The transformation of this enone to physoperuvine (**260**) was preceded in the literature⁹⁵ but no experimental

details were given. Chemoselective hydrogenation of **600** provided the natural alkaloid which exists predominantly in its hemiaminal form **260**.^{114c}

Scheme 100

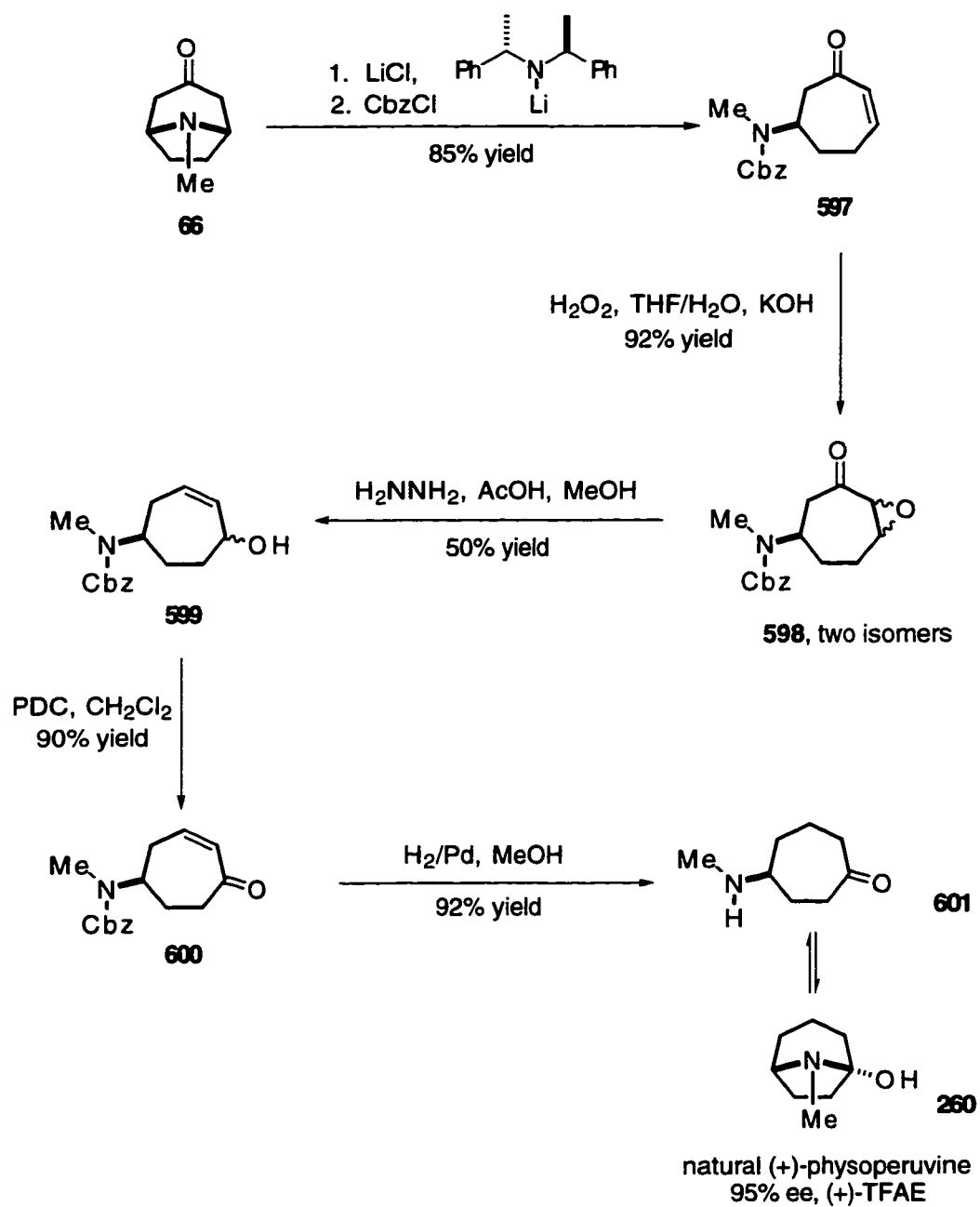

3.7. Reactions of cyanide with methoxycarbonyltropanone derivatives

One of the interesting reactions observed during the studies on alkoxy-carbonylation of tropanone was the formation of the Grob fragmentation product **480** (Scheme 101, cf. also Section 3.1). The scalemic, polyfunctionalized pyrroline **480**, could serve as the starting material for EPC synthesis of several natural products (Scheme 101).

Scheme 101

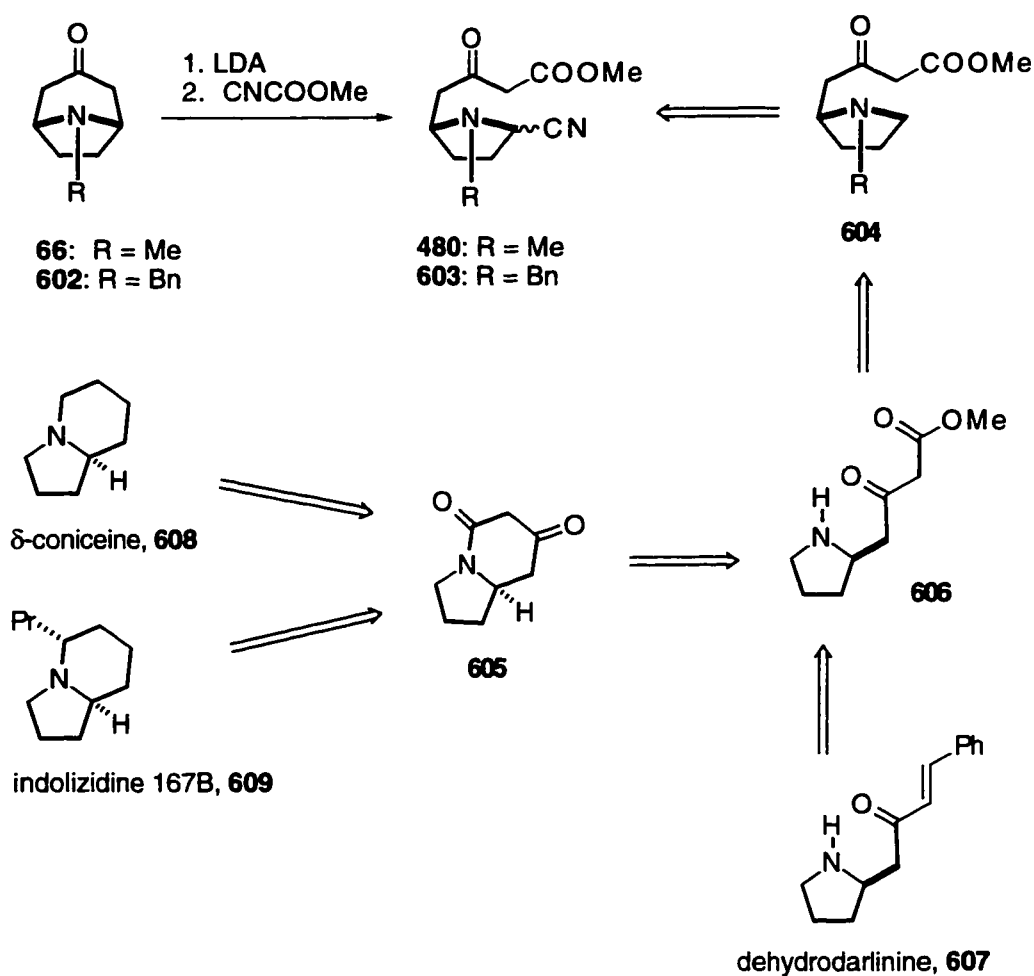

In order to do so it was necessary to find conditions for the formation of **480** or its *N*-benzyl analog **603** and for the removal of the cyanide group from these compounds.

Treating methoxycarbonyltropinone (**240**) with a solution of KCN in aqueous THF resulted in a fast reaction leading to the nitrile **480** which was isolated as a mixture of isomers. The NMR spectrum of the extracted crude product indicated almost complete conversion of the starting material to **480** but an attempt at a chromatographic purification resulted in a substantial reversal of the reaction. Similar experiments with the *N*-benzyl derivative **602** proved that the cyanide **603** forms to a certain degree in solution but could not be isolated or purified. The product was quantitatively transformed to starting material on a silica gel column. Reactions in aqueous methanol and ethanol gave similar results. It was decided to briefly investigate if methoxycarbonyltropinone underwent a similar reaction with other nucleophiles (different than CN⁻). Five reagents were tested: KOH, KI, KOAc, KCNO, and KSCN but only the last one showed a behavior similar to KCN and to much lesser extent. Thus, the cyanide ion seemed to be the only nucleophile capable of bringing about the Grob type fragmentation leading to **611** (Scheme 102).

Scheme 102

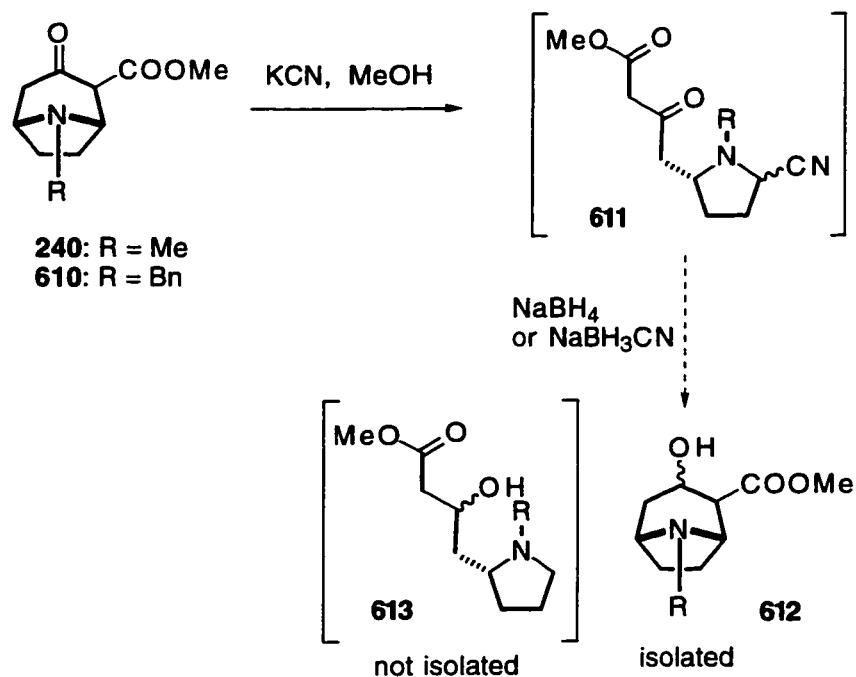

Since the lack of stability of the Grob fragmentation products **480** and **603** was making isolation difficult, I have tried to convert them, *in situ*, into a stable derivative. In principle, this could be done in several different ways e.g., by a reductive removal of the cyanide group, reduction of the ketone group, or deprotection of the amine followed by cyclization to the bicyclic amide **605**. Each of these methods was attempted, but all failed due to complications caused by the reversibility of the ring opening reaction. For example, reduction with NaBH₄ (or with BH₃) gave a complex mixture of products (mostly the products of reduction of **611**) and the reaction of the deprotected methoxycarbonylnortropinone with potassium cyanide failed to give **605** (Scheme 102 and 103). Because of the mounting difficulties, and time constraints, this part of my project was eventually abandoned.

Scheme103

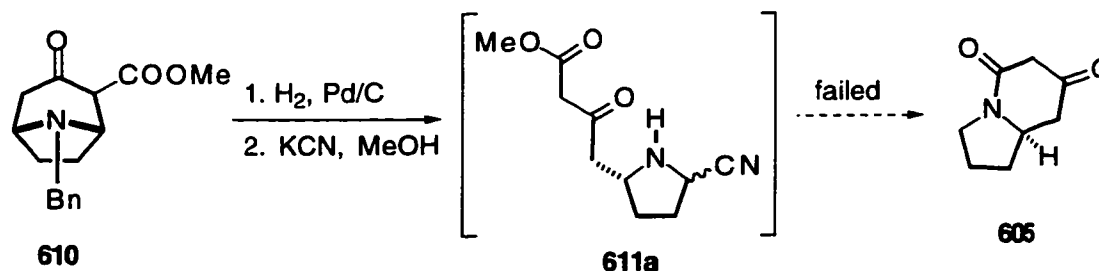

3.8. Other reactions of tropanone lithium enolates with electrophiles

To broaden the scope of the enantioselective deprotonation approach to the synthesis of natural products, several new reactions were tested i.e. reactions tropanone lithium enolate analogs **616** and **615**. These enolates could be theoretically prepared by the same methods used for deprotonation of tropanone.

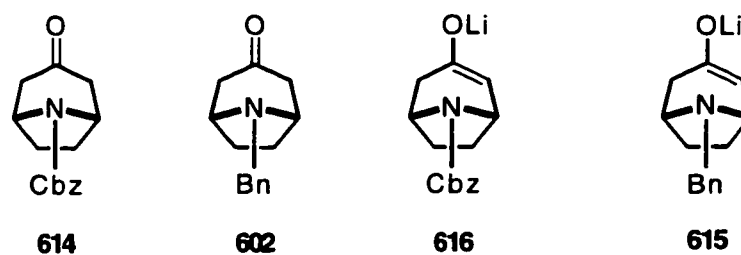

The compounds necessary for this study were synthesized from tropanone by modified literature procedures.^{158,159} Demethylation of tropanone (**66**) with benzyl and 2,2,2-trichloroethyl chloroformate gave nortropanone derivatives **614** and **617** respectively. The deprotection of Troc group with zinc in methanol was combined with the reductive amination of benzaldehyde in a "one pot" procedure for the preparation of *N*-benzyl nortropanone **602** (Scheme 104).

Scheme 104

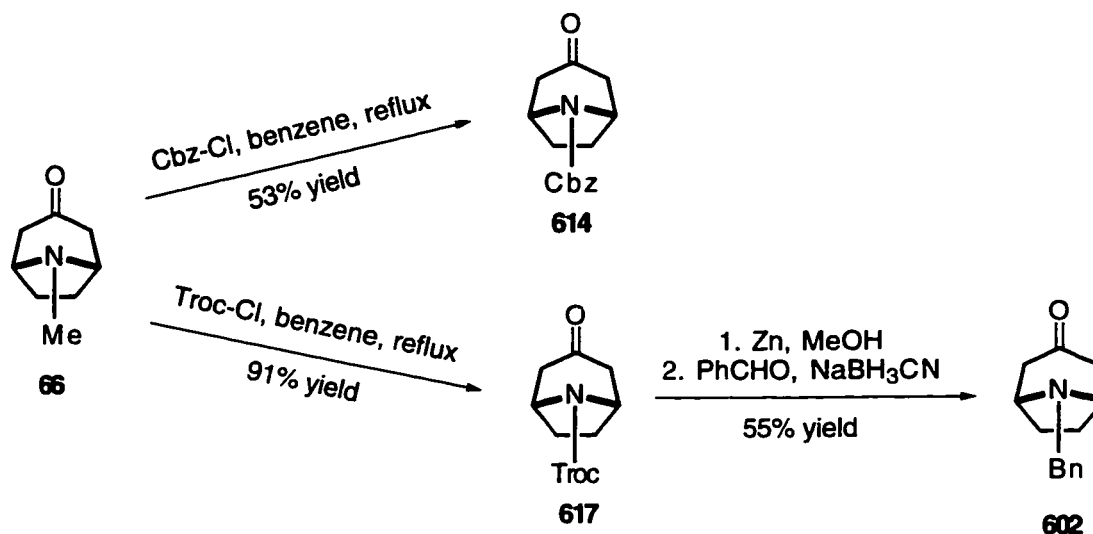

The reaction of tropinone lithium enolate with phenyl disulfide gave 75% yield of **618** which could be used for the 1,2-transposition of the carbonyl group (Scheme 105).¹⁷⁴ Such transposition could be a valuable reaction sequence in synthetic studies towards 2- or 4-carbonyl derivatives of tropinone e.g., baogongteng A (**140**).

Scheme 105

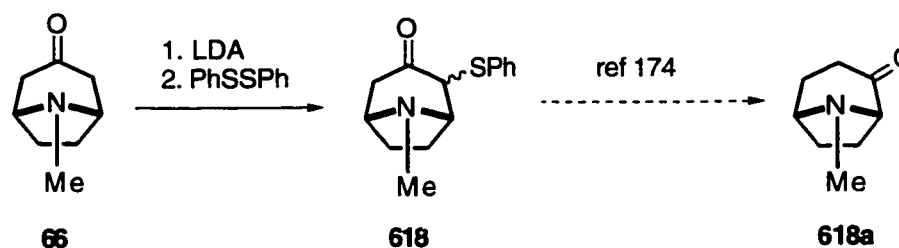

The generation of enolates **616** and **615** with LDA, under typical conditions, was successful. The reactions of these enolate with methyl cyanofornate, benzaldehyde, and acyl cyanides proceeded as expected (Scheme 106). However, the attempted reaction of the *N*-benzyltropinone

enolate (**615**) with three different chloroformates (i.e., methyl, benzyl, and 2,2,2-trichloroethyl chloroformate) resulted in the recovery of starting material.

Scheme 106

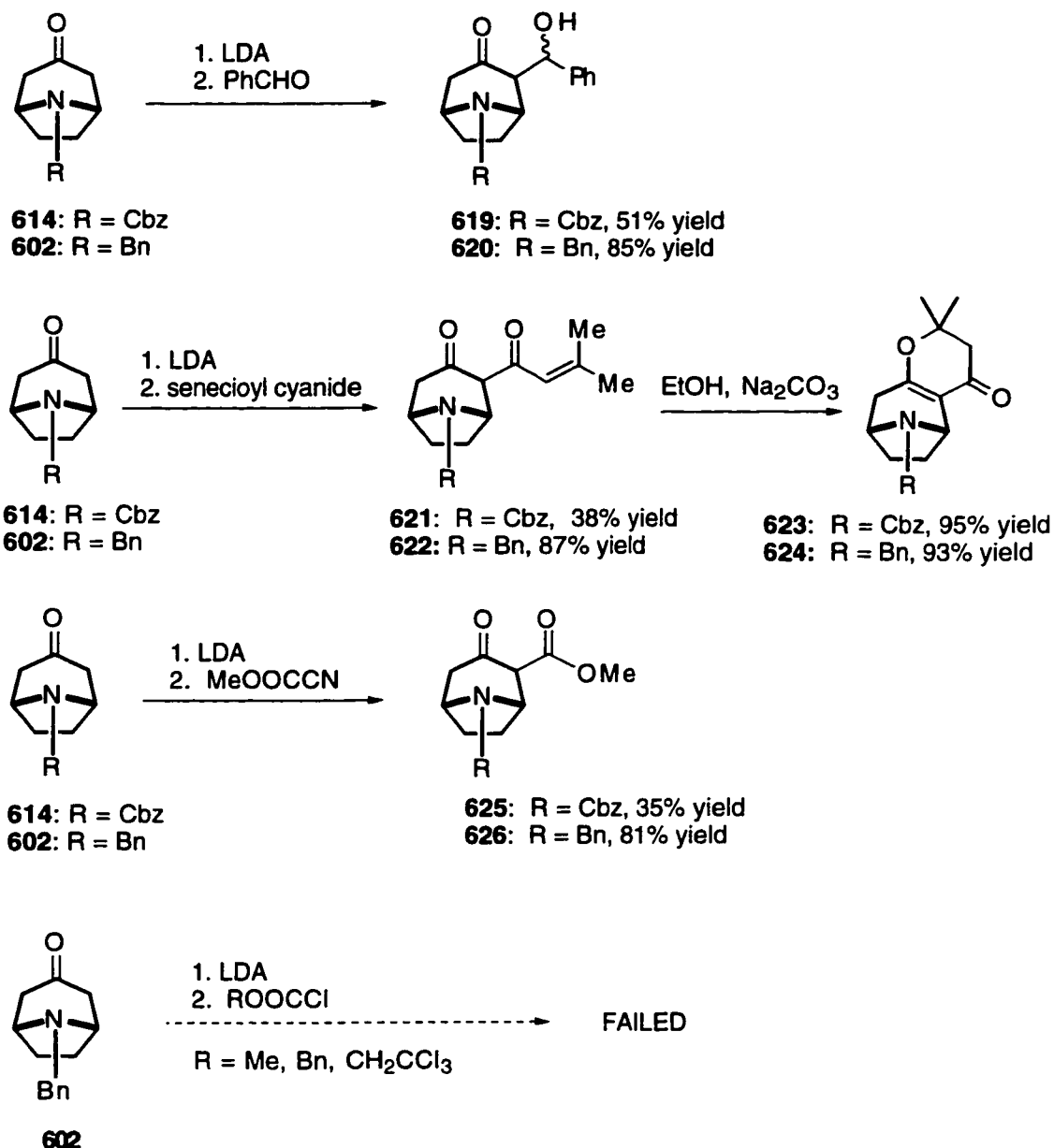

Since the benzyl group and the Cbz group can be easily cleaved by hydrogenolysis, lithium enolates of the *N*-nortropane derivatives **602** and **614** may offer access to the demethylated analogs of several tropane alkaloids.

3.9. Conclusions

The enantioselective syntheses presented in this thesis demonstrate that nonracemic tropinone lithium enolate is an excellent reagent for EPC synthesis of different tropane alkaloids. Application of the protocols for the highly enantioselective preparation of scalemic tropinone lithium enolate from tropinone, developed during methodological studies (Section 2), resulted in the preparation of natural products having enantiomeric purities of 91-95% ee. These syntheses also established the absolute configurations of pyranotropanes, chalcostrobamine, knightinol and (-)-7 β -acetoxy-3 α -tigloyloxytropane. These configurations are depicted in Figure 2.8. The relative stereochemistry of knightinol was also established. To the best of my knowledge, the configurations of these natural products have not previously been known. Some structures of these alkaloids cited in the literature³³ which were chosen arbitrarily proved to be incorrect.

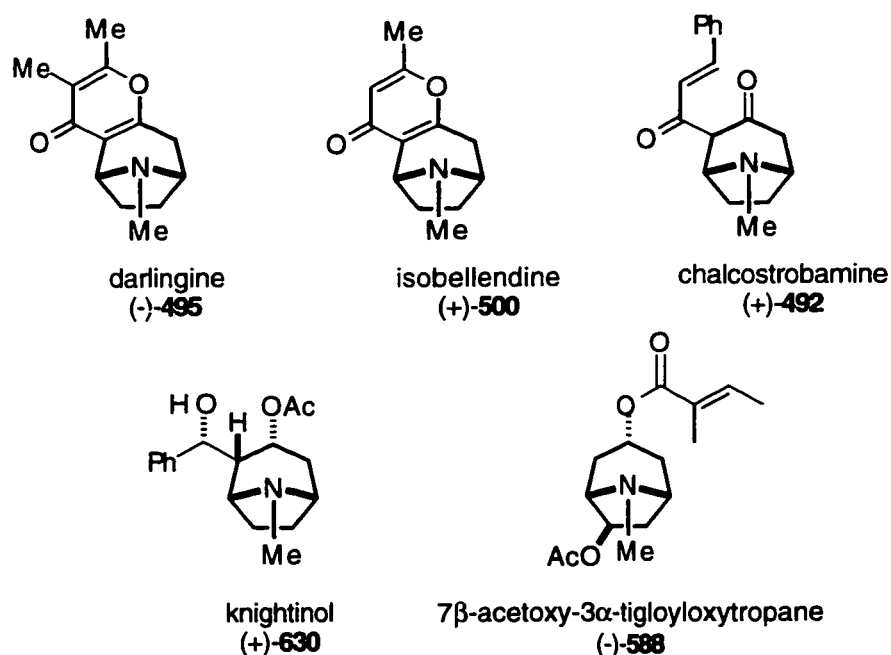

Fig. 2.8. Absolute configuration of natural tropane alkaloids correlated through syntheses via enantioselective deprotonation

CHAPTER III : SUMMARY AND FUTURE WORK

1. Summary

The methodological studies resulted in elaboration of two procedures for enantioselective deprotonation of tropinone with synthetically useful selectivity. A new protocol for the preparation of scalemic tropinone enolate, *via* deprotonation, with lithium amide **442a**/lithium chloride mixture generated *in situ* was demonstrated to provide enantioselectivity as high as 97% ee. The progress made in control of enantioselectivity of deprotonation by optimization of the reaction conditions is shown graphically in Figure 3.1.

Scalemic tropinone lithium enolate, prepared *via* enantioselective deprotonation of tropinone, was used as the common chiral precursor in the syntheses of 9 natural products representative of 7 different groups of tropane alkaloids. All syntheses gave products with high enantiomeric purity, ranging from 91 to 95% ee, and good to excellent overall yields (Table 3.1). The syntheses have also established or confirmed the absolute configurations of the synthesized alkaloids.

It was demonstrated, that either enantiomer of the target product could be obtained with ease by using different chiral amides for the initial deprotonation of tropinone. The absolute stereochemistry of the synthetic chiral tropane derivatives can be controlled at will by choice of the deprotonating reagent. Both enantiomers of the chiral amines used in this work can be

obtained from commercially available materials. In addition, the chiral amines (**450** and **442**) can be recovered after workup (typically in more than 95%), purified, and reused.

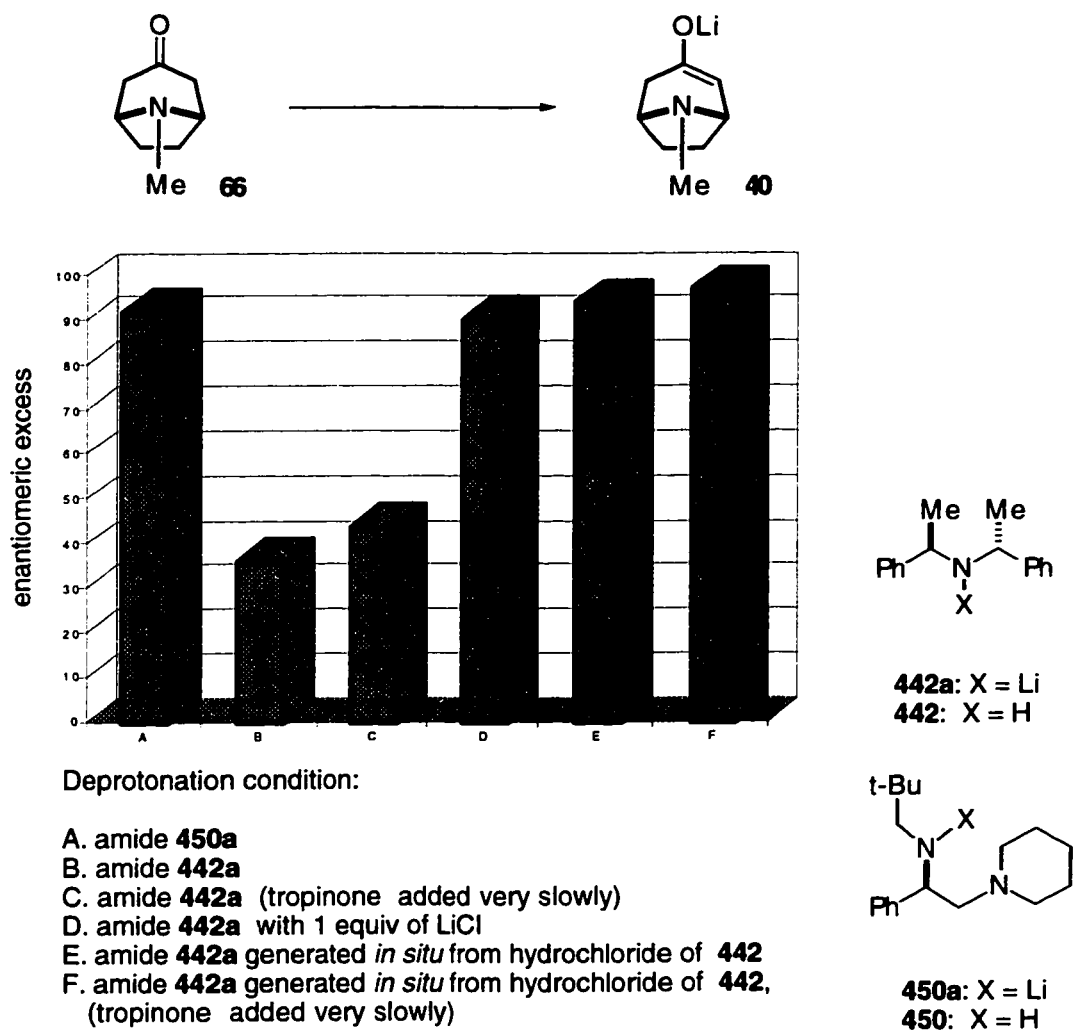

Fig. 3.1. Effect of optimization of reaction conditions on enantioselectivity of deprotonation of tropinone

Clearly, enantioselective deprotonation of tropinone with chiral lithium amides provides a key to an excellent, and general approach to EPC synthesis of natural and unnatural tropane derivatives.

Table 3.1. Natural products synthesized *via* enantioselective deprotonation of tropinone.

entry	product	overall yield from 66	enantiomeric purity
1	chalcostrobamine (+)- 492	75%	92% (NMR)
2	<i>ent</i> -chalcostrobamine (-)- 492	73%	95% (NMR)
3	<i>ent</i> -darlingine (-)- 495	53%	91% (opt. rot.)
4	<i>ent</i> -isobellendine (-)- 500	48%	92% (NMR)
5	<i>ent</i> -knightinol (-)- 557	46%	97% (NMR)
6	alkaloid KD-B (-)- 562	64%	94% (NMR)
7	<i>ent</i> -anhydroecgonine methyl ester (+)- 485	72%	93% (NMR)
8	(+) $3\alpha,7\beta$ -diacetoxytropane (+)- 587	37%	96% (opt. rot.)
9	(-) 7β -acetoxy- 3α -tigloyloxytropane (-)- 588	36%	>95% (opt. rot)
10	physoperuvine (+)- 260	32%	95% (NMR)

2. Future Work

The synthesis of the 7β -acetoxytropinone (**585**) constitutes a formal enantioselective synthesis of baogongteng A (cf., Schemes 25 page 32 and 96 page 125). The combination of the two synthetic schemes could correlate the absolute configuration of baogongteng A with configurations of other alkaloids synthesized in this thesis. This would call for a diastereoselective deprotonation of 7β -functionalized tropinone as depicted in Scheme 107. It could be interesting from a synthetic point of view to examine how oxygen substituents at C-6 or C-7 would affect the inherent preference of chiral lithium amides (e.g., the bidentate amide **450a**) for abstracting the axial C-2 hydrogen

in the tropinone system. The diastereomerically enriched lithium enolate **631** could also be used in the EPC synthesis of tropane alkaloids substituted at C-7 and C-2 (e.g., alkaloid KD-F, Scheme 107).

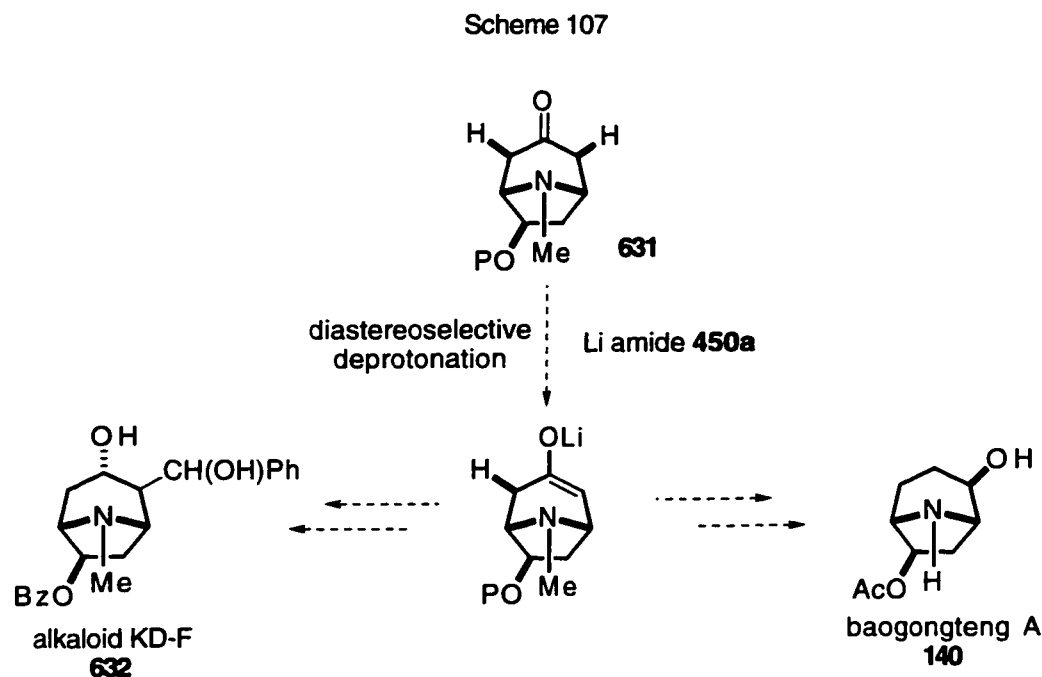

The methodological investigations should be continued to test the influence of additives other than lithium salts. An interesting effect of zinc chloride on enantioselective deprotonation of cyclic ketones, reported recently by Simpkins,³¹ should prompt new studies on the effects of transition metal salts on asymmetric proton transfer reactions. For instance, one could ask a question about the effect of lanthanide salts (e.g., cerium (III) chloride) on selectivity of deprotonation of tropinone.

Certainly, deprotonation of tropinone and related ketones with chiral lithium amides can be a very fruitful and challenging field for synthetic organic chemists.

CHAPTER IV : EXPERIMENTAL

1. General methods

All air sensitive reactions were carried out under argon.¹⁴⁸ Tetrahydrofuran was distilled under nitrogen from sodium and benzophenone. Diisopropylamine was distilled from calcium hydride and stored over 4A molecular sieves. Acetone was dried with molecular sieves 3A for 4 h before use. Chiral amines were distilled under vacuum. Lithium chloride, bromide and iodide were dried at 130-150 °C in vacuum for 12 h. Lithium perchlorate was dried (melted) at 200 °C in an oven for 12 h. The salts were then dissolved in THF and stored under argon. n-BuLi was periodically titrated using 2,5-dimethoxybenzyl alcohol as a standard and indicator.

Flash column chromatography¹⁴⁹ and dry-column flash chromatography¹⁵⁰ were carried out using Merck silica gel 60 (230-400 mesh) and Sigma silica gel Type H (10-40 μm) respectively, and TLC was performed on precoated glass plates (Merck, silica gel 60, F254). The spots were detected using UV light (254 nm), the Dragendorff reagent¹⁵¹ or with a developing solution of phosphomolybdic acid and ceric sulfate followed by charring on a hot plate.

Melting points and boiling points are uncorrected. Melting points were measured on a Gallenkamp melting point apparatus. Optical rotation was measured on a Perkin Elmer 241 Polarimeter (1 dm cell, 1 mL), all concentrations are given in g/100 mL. Mass spectra were recorded on a VG

analytical retrofit of a single sectored, magnetic scanning MS-12 (low resolution) or a double sectored VG 70 VSE (high resolution) and are reported as m/z ratio (relative intensity). Electron impact (EI) ionization was accomplished at 70 eV and chemical ionization (CI) at 50 eV. The CHN elemental analyses were done using a Perkin Elmer 2400 CHN Elemental Analyzer. Infrared (IR) spectra were recorded on a Biorad FTS-40 Fourier Transform interferometer by a diffuse reflectance cell method. Only diagnostic peaks frequencies are reported. Proton magnetic resonance (^1H NMR) and ^{13}C nuclear magnetic resonance (^{13}C NMR) spectra were recorded on a Bruker AM-300 (300 MHz) spectrometer in CDCl_3 solvent. Chemical shifts are reported in ppm of δ scale with TMS as the internal standard.

Gas chromatography was performed using a Hewlett Packard 5890A instrument fitted with a methyl silicone gum column (HP-1, 5 m x 0.53 mm) unless otherwise stated.

Chromatographic analyses of enantiomeric purity were done on a computer controlled Gilson HPLC system with a ChiraDex 250-4 column (Merck) and an UV detector (at 254 nm). The solvent used was 1:1 methanol/phosphate buffer (pH = 6.8, $c=0.025$ M) at 1 mL/min flow rate, and the sample concentration was 1 mg/mL. Statistically estimated error of the measurement was $\pm 1\%$ ee.

In order to obtain a high signal to noise ratio, ^1H -NMR spectra for analysis of the ee were recorded on 20-25 mg samples in 0.4 mL CDCl_3 in the presence of 20 mg of *S*-(+)-2,2,2-trifluoro-1-(9-anthryl)ethanol (*S*-(+)-TFAE). Statistically estimated error of the measurement was $\pm 2\%$ ee.

2. Methodological study

2.1. Syntheses of chiral amines derived from α -methylbenzylamine

(S)-(+)-N-Phenyl-1-phenylethylamine (ref 152)



A solution of (S)-(-)- α -methylbenzylamine (10.6 g, 87.6 mmol, 4 equiv) in THF (90 mL) was cooled to 0 °C and treated with n-BuLi in hexane (2.2 M, 40 mL, 88 mmol). Reaction mixture turned red. After 45 minutes, freshly distilled bromobenzene (4.4 mL, 4.14 g, 22 mmol) in THF (6 mL) was added. The mixture was warmed up to rt and left for 6 days. Aqueous carbonate quench, and extraction (Et₂O), followed by vacuum distillation gave S-(-)- α -methylbenzylamine (bp 70 °C/25 mmHg, 6.66g, 63% recovery) and the product (bp 90-100 °C/0.5 mmHg, 3.86g, 89%).

Purification: Crystallization of hydrochloride from EtOH, mp 210-212 °C

$[\alpha]^{26}_{\text{D}}$ +25.1 (c 2.00, EtOH) amine lit.¹⁵² $[\alpha]^{24}_{436}$ -19.5 (c 1, MeOH)

$[\alpha]^{26}_{\text{D}}$ -135 (c 1.21, EtOH) hydrochloride

¹H-NMR: 7.40-7.13 (m, 5H), 7.12-7.05 (m, 2H), 6.68-6.45 (m, 3H), 4.48 (pent, $J = 6$ Hz, 1H), 4.00 (br s, 1H), 1.50 (d, $J = 6.5$ Hz, 3H).

(S)-(-)-N-Isopropyl-1-phenylethylamine (ref 25)

This compound was prepared according to a general literature procedure for reductive amination of ketones.¹⁵³ For convenience of the reader the specific procedure is given below.

Dry acetone (4.8 mL, 3.8 g, 65 mmol) and sodium cyanoborohydride (2.14 g, 34 mmol) were added to a solution of (S)-(-)- α -methylbenzylamine (3.84 g, 32 mmol) in dry methanol (80 mL) at 0 °C. The solution's pH was adjusted from 10 to 6 by addition of glacial acetic acid (about 2.2 mL). After stirring for 12 h at rt the solvent was removed under vacuum and aqueous solution of K₂CO₃ (40 g in 100 mL of water) was added. The mixture was extracted with Et₂O (3 x 50 mL) and the combined extracts were dried (MgSO₄). The solvent was removed under vacuum and the residue was distilled. The distillation (bp 81-83 °C/20 mmHg) gave a colorless liquid (4.5 g, 86%).

$[\alpha]_{25}^D$ -61 (c 2.14, MeOH).

¹H-NMR: 7.40-7.23 (m, 5H), 3.93 (q, J = 6.5 Hz, 1H), 2.65 (sept, J = 6.5 Hz, 1H), 1.38 (d, J = 6.5 Hz, 3H), 1.07 (d, J = 6.5 Hz, 3H), 1.05 (d, J = 6.5 Hz, 3H).

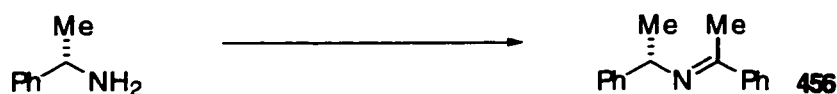
(S)-(+)-N-(1-Phenylethyl)-1-phenylethanimine (ref 154)

Modified procedure from ref 154

A mixture of (*S*)-(-)- α -methylbenzylamine (9.23 g, 76 mmol), acetophenone (12.1g, 101 mmol), dry benzene (160 mL) and *p*-TsOH (0.19 g, 1 mmol) was refluxed in the Soxhlet apparatus containing molecular sieves (4A) for 5 days (GC analysis of the reaction mixture showed substrate/product ratio 1:45). After the mixture was cooled in ice, it was washed with aqueous K_2CO_3 and dried with $MgSO_4$. The solvent was removed under vacuum and the crude product (16.9 g, 98%) was used in the next step. An analytical sample was purified by distillation (bp 115 °C/1 mmHg).

$R_f = 0.65$ (4:1 hexane/AcOEt)

$[\alpha]^{25}_D +48.8$ (c 1.50, MeOH).

1H -NMR: 7.95-7.88 (m, 2H), 7.57-7.23 (m, 8H), 4.90 (q, $J = 6.5$ Hz, 1H), 2.33 (s, 3H), 1.62 (d, $J = 6.5$ Hz, 3H).

(S,S)-(-)-N,N-Bis(1-phenylethyl)amine (ref 154)

Procedure was adapted from ref 154

The crude imine **456** (product from previous experiment) (16.9 g, 74.5 mmol) was dissolved in THF (70 mL) and hydrogenated on 30% Pd/C catalyst (0.4 g) in a Paar apparatus for 5h. When the GC analysis showed complete conversion, the catalyst was filtered off (Celite) and the solvent was removed under vacuum. High vacuum distillation (bp 112-115 °C/0.2 mmHg) of the residue gave the amine (13.6 g, 80%) as a mixture of diastereoisomers (9.8:1, GC).

The diastereomerically pure amine was obtained by crystallization of the hydrochloride from water/ethanol mixture followed by conversion to the free amine with aqueous NaOH (cf. the following experiment).

$R_f = 0.22$ (9:1 hexane/AcOEt)

$[\alpha]^{25}_D -16.5$ (c 1.00, MeOH)

$^1\text{H-NMR}$: 7.43-7.22 (m, 10H), 3.55 (q, $J = 6.5$ Hz, 2H), 1.50 (br s, 1H), 1.35 (d, $J = 6.5$ Hz, 6H).

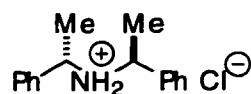
(S,S)-(-)-N,N-Bis(1-phenylethyl)amine hydrochloride (ref 154)

The amine **442** (from the previous experiment) was diluted with ethanol (20 mL) and the solution was poured carefully, with constant stirring, into a boiling mixture of water (60 mL), ethanol (40 mL) and concentrated hydrochloric acid (7 mL). The resulting hot solution was set aside for crystallization. After the first crop of crystals (10.7 g) was collected and half of the solvent was evaporated crystallization yielded the second crop of the product (2 g). Total yield 12.7 g, 81%.

The HCl salt was dried in a vacuum desiccator for 24 h over KOH, before being used in the deprotonation experiments.

$[\alpha]_{28}^D -86.6$ (c 4.05, EtOH)

$[\alpha]_{25}^D -74.5$ (c 1.04, MeOH)

mp 262-263 °C lit.¹⁵⁴ >300 °C

Anal. (hydrochloride) Calcd for C₁₆H₂₀NCl: C, 73.98; H, 6.98; N, 5.39. Found: C, 73.76; H, 7.13; N, 5.21.

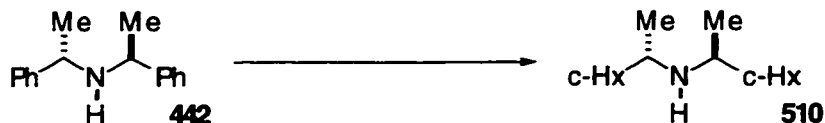
(S,S)-(-)-N,N-Bis(1-cyclohexylethyl)amine

The amine **442** (0.125 g, 0.55 mmol) was dissolved in glacial acetic acid (2 mL) and hydrogenated on a PtO₂ catalyst (0.04 g) in a Paar apparatus for 8h. The reaction mixture was poured into aqueous K₂CO₃ solution and extracted with CH₂Cl₂. The extracts combined were dried, and the solvent was removed under vacuum. The high vacuum distillation (bp 118-123 °C/0.2 mmHg) of the residue gave the amine (0.084 g, 64 %).

An analytical sample was purified by SCC (1-10% hexane/AcOEt)

R_f = 0.39 (9:1 hexane/AcOEt)

[α]_D²⁷ -26.8 (c 1.50, MeOH)

¹H-NMR: 2.50 (pent, *J* = 5.5 Hz, 2H), 1.87-1.62 (m, 10H), 1.40-0.92 (m, 19H).

IR: (C-H) 2922 cm⁻¹.

MS: (EI) 154 (100), 97 (18), 83 (22), 81 (15), 71 (18), 69 (39), 57 (32), 55 (32).

Anal. (hydrochloride) Calcd for C₁₆H₃₂NCl: C, 70.16; H, 11.78; N, 5.11.

Found: C, 70.26; H, 11.85; N, 5.05.

(S)-(-)-N-(1-Phenylethyl)-1-(1-naphthyl)ethanimine

A mixture of (S)-(-)- α -methylbenzylamine (9.3 g, 77 mmol), 1-acetonaphthone (11.9 g, 70 mmol), dry benzene (160 mL) and *p*-TsOH (0.19 g, 1 mmol) was refluxed in the Soxhlet apparatus containing molecular sieves (4A) for 4 days (molecular sieves were changed four times). When the GC analysis of the reaction mixture showed a substrate/product ratio at 1:48, the mixture was cooled in ice and then washed with aqueous K_2CO_3 and dried with $MgSO_4$. The solvent was removed under vacuum and the crude product (19.1 g, 98%) was used in the next step. An analytical sample was distilled (bp 150 °C/0.03 mmHg). The product (mixture of isomers, 1:1 from NMR) was a yellowish liquid which solidified on standing.

$[\alpha]^{28}_D -139$ (c 1.50, MeOH), mutarotation

1H -NMR: 8.00-6.96 (m, 12H), 4.30-4.18 (m, 1H), 2.53 (s, 50% of 1H), 2.48 (s, 50% of 3H), 1.47 (d, $J = 4.5$ Hz, 50% of 3H), 1.42 (d, $J = 4.5$ Hz, 50% of 3H).

IR: (N=H) 1647 cm^{-1} .

MS: (EI) 263 (65), 272 (21), 258 (20), 269 (20), 168 (40), 154 (14), 127 (12), 105 (100).

HRMS: 273.151 (M^+), calcd for $C_{20}H_{19}N$ 273.152.

(1*S*,1'*S*)-(-)-1'-(1-Naphthyl)-1-phenyl-*N,N*-diethylamine

The crude imine **458** (19.1 g, 68.5 mmol) was dissolved in methanol (90 mL) and hydrogenated on 30% Pd/C catalyst (0.5 g) in a Paar apparatus for 5 days. When the GC analysis showed complete conversion, chloroform (90 mL) was added to the mixture in order to dissolve the precipitated crystals. The mixture was filtered through Celite and the solvents were removed in vacuum. A recrystallization of the crude solid product from methanol (70 mL) gave the diastereomerically pure amine (2 crops, 14.1 g, 75%) in the form of white crystals.

$[\alpha]_D^{27}$ -144 (c 1.20, MeOH)

mp 98-100 °C (MeOH)

$[\alpha]_D^{27}$ (hydrochloride) +24.2 (c 1.00, MeOH)

mp (hydrochloride) 260-262 °C with decomposition (EtOH)

¹H-NMR: 8.10-7.77 (m, 4H), 7.69-7.22 (m, 8H), 4.54 (q, $J = 6.5$ Hz, 1H), 3.73 (q, $J = 6.5$ Hz, 1H), 1.85 (br s, 1H), 1.51 (d, $J = 6.5$ Hz, 3H), 1.46 (d, $J = 6.5$ Hz, 3H).

IR: (N-H) 3316 cm^{-1} .

MS: (EI) 275 (27), 261 (22), 260 (93), 156 (99), 155 (100), 153 (18), 149 (20), 105 (83).

Anal. (hydrochloride) Calcd for $\text{C}_{20}\text{H}_{22}\text{NCl}$: C, 77.03; H, 7.11; N, 4.49. Found: C, 77.28; H, 7.14; N, 4.50.

2.2. Synthesis of chiral amines derived from phenylglycine:*

(R)-tert-Butoxycarbonylphenylglycine (ref 155)



(*R*)-Phenylglycine (4.53 g, 0.03 mmol) was added to a stirred solution of NaOH (1.32 g, 0.033 mmol) in water (33 mL) and *t*-BuOH (18 mL). Di-*tert*-butyl dicarbonate (6.69 g) was added to the resulting solution in 1 mL portions over 45 minutes (a white precipitate was formed). The resulting suspension was stirred at rt overnight. The cloudy mixture was diluted with water (20 mL) and extracted with dichloromethane (1 x 60 mL). The organic extract was washed with diluted aqueous NaOH. The NaOH wash was combined with the basic aqueous layer from first extraction, cooled to 5 °C (ice) and slowly acidified with cold diluted H₂SO₄ (1.2 equiv vs. NaOH). The white product precipitated and was extracted with dichloromethane (3 x 50 mL). The combined organic layers were washed with water (2 x 50 mL) to remove *t*-BuOH, dried (MgSO₄) and concentrated under vacuum at a temperature not exceeding 30 °C. To remove the remaining *t*-BuOH the crude product was taken up in dichloromethane (100 mL) and the solvent was removed under vacuum. This was repeated 3 times. The product was dried under high vacuum to give a white crystalline solid (6.22 g, 83%).

mp 88-91 °C, (racemate 113-114 °C)

¹H-NMR: 8.00, 5.51 (br, 1H), 7.48-7.28 (m, 5H), 5.34, 5.15 (d, d, 1H), 1.46, 1.19 (s, s, 9H).

* At the time when these syntheses were being developed in our laboratory the detailed procedures for preparation of these chiral amines were not published. Existing literature reports were difficult to reproduce.

(R)-1-[2-tert-Butoxycarbonylamino]-2-phenylacetyl]piperidine

(ref 156)

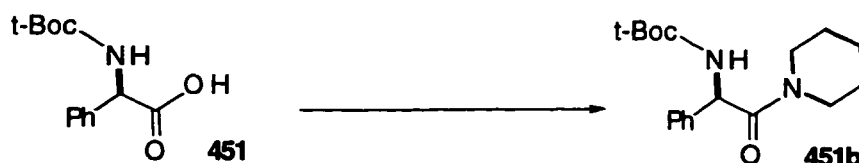

A solution of DCC (3.09 g, 15 mmol) in dry dichloromethane (12 mL) was cooled to 0 °C and t-Boc-phenylglycine **451** (3.765 g, 15 mmol) in dry CH₂Cl₂ (10 mL) was added using a pipette. After 15 minutes of stirring at 0 °C, piperidine (2.1 mL, 20 mmol) was added slowly over 3 h using a syringe pump (the reaction mixture turned cloudy). The resulting mixture was stirred at rt overnight. The solvent was removed under vacuum, AcOEt (60 mL) was added, and the resulting suspension was stirred for 30 minutes. The white precipitate (dicyclohexylurea) was filtered off and washed with AcOEt (60 mL). Removal of solvent from the filtrate gave the crude product (4.78 g, quantitative yield), which was crystallized from hexane to give fine white crystals (2.86 g, 60%). Less pure material can be obtained by concentration of the mother liquor and a second crystallization.

R_f = 0.23 (4:1 hexane/AcOEt)

mp 95-96 °C lit.¹⁵⁶ 95.5-98 °C

¹H-NMR: 7.40-7.26 (m, 5H), 6.13, (d, *J* = 10 Hz, 1H), 5.55 (d, *J* = 10 Hz, 1H), 3.80-3.70 (m, 1H), 3.50-3.38 (m, 1H), 3.35-3.20 (m, 2H), 1.68-1.33 (m, 5H), 1.38 (s, 9H), 1.00-0.85 (m, 1H).

Racemic modification: 70% yield, mp 142-145 °C (AcOEt).

(S)-(+)-2,2,2-Trifluoro-1-(9-anthryl)ethanol splits t-Bu peaks.

(R)-1-[2-*tert*-Butoxycarbonylamino]-2-phenylacetyl]-4-methylpiperazine (ref 156)

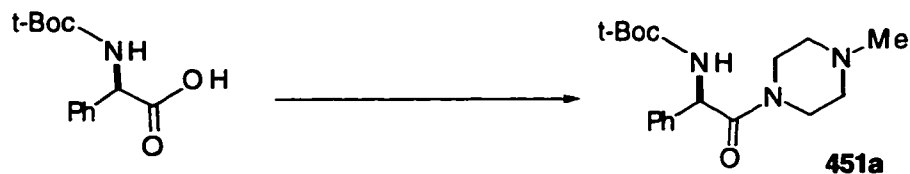

This compound was prepared according to the procedure described above.

Purification was done *via* FCC in 3-5% MeOH in CH₂Cl₂

¹H-NMR: 7.40-7.26 (m, 5H), 6.08, (d, *J* = 10 Hz, 1H), 5.55 (d, *J* = 10 Hz, 1H), 3.80-3.50 (m, 2H), 3.50-3.20 (m, 2H), 2.45-2.10 (m, 3H), 2.18 (s, 3H), 1.90-1.70 (m, 1H), 1.39 (s, 9H).

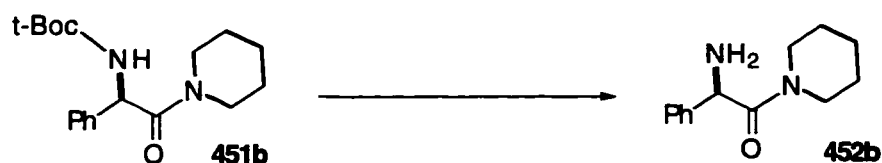
(R)-1-[2-Amino-2-phenylacetyl]piperidine (ref 156)

Trifluoroacetic acid (50 mL) was added to the t-Boc-phenylglycine piperidide (8.09 g 25.4 mmol) at 0 °C and the solution was stirred for 1 h. Benzene (80 mL) was added to the resulting mixture and trifluoroacetic acid was removed with benzene under vacuum. This was repeated 2 times. The residue was made basic by treating with an excess of aq NaOH, and was extracted with diethyl ether (3 x 60 mL), dried (MgSO₄) and concentrated under vacuum to give the product (5.19 g, 94%).

¹H-NMR: 7.40-7.23 (m, 5H), 4.75 (s, 1H), 3.80-3.68 (m, 1H), 3.50-3.40 (m, 1H), 3.30-3.15 (m, 2H), 2.19 (s, 2H), 1.63-1.25 (m, 5H), 1.05-0.85 (m, 1H).

(R)-1-[2-Amino-2-phenylacetyl]-4-methylpiperazine (ref 156)

This product was prepared by the procedure given in the previous experiment.

¹H-NMR: 7.40-7.23 (m, 5H), 4.75 (s, 1H), 3.84-3.68 (m, 1H), 3.60-3.47 (m, 1H), 3.43-3.18 (m, 2H), 2.19 (s, 3H), 2.60-2.35 (m, 3H), 2.28-2.10 (m, 2H), 1.85-1.70 m, 1H).

(R)-1-[2-(2,2-Dimethylpropyl)amino-2-phenylacetyl]piperidine

(ref 156)



Phenylglycine piperidide (8.29 g, 38.0 mmol) was dissolved in dry MeOH (180 mL), and sodium cyanoborohydride (3.50 g, 55.6 mmol) was added, followed by pivalaldehyde (4.54 g, 53 mmol). The pH of the mixture was adjusted to about 6 by addition of glacial acetic acid (reaction mixture warmed up) and the resulting solution was left overnight. The reaction mixture was cooled (salt-ice), treated with aqueous solution of K_2CO_3 (25 g) and extracted with Et_2O (3 x 60 mL). The combined extracts were dried ($MgSO_4$) and concentrated under vacuum to give the off-white solid product (9.63 g, 88%).

1H -NMR: 7.40-7.23 (m, 5H), 4.73 (s, 1H), 3.80-3.68 (m, 1H), 3.50-3.40 (m, 1H), 3.30-3.15 (m, 2H), 2.30-2.07 (m, 3H), 1.63-1.25 (m, 6H), 0.95 (s, 9H).

(R)-1-[2-(2,2-Dimethylpropyl)amino-2-phenylacetyl]-4-methylpiperazine (ref 156)



This product was prepared by the procedure given in the previous experiment.

¹H-NMR: 7.50-7.30 (m, 5H), 4.78 (s, 1H), 3.84-3.40 (m, 4H), 2.70-2.20 (m, 4H), 2.32 (s, 3H), 2.25-2.00 (m, 2H), 0.95 (s, 9H).

(R)-1-[(2,2-Dimethylpropyl)amino-2-phenylethyl]piperidine (ref 157)

Crude *N*-neopentylphenylglycine piperidide **453b** (9.63 g, 0.033 mol) was dissolved in Et₂O (160 mL) and the solution was added to an ice-cooled suspension of LiAlH₄ (4.00 g, 0.105 mol) in Et₂O (100 mL). The resulting mixture was left stirring at rt overnight. Concentrated aqueous ammonia solution (ca. 2 mL) and 40% K₂CO₃ solution (ca. 2 mL) were added to the reaction mixture. Stirring was continued until all LiAlH₄ decomposed (white precipitate). Celite (ca. 3 g) and MgSO₄ (ca. 3 g) were added slowly to the resulting suspension with stirring. After 10 minutes the white solid was filtered off and washed with chloroform (2 x 50 mL). The combined organic solutions were concentrated under vacuum to give a yellowish oil (8.5 g, 93%).

Purification: The crude amine (8 g) was dissolved in a small amount of hexane/AcOEt mixture (4:1) and the solution was filtered through a 12 cm long bed (ϕ 45 mm) of flash silica (eluent: hexane/AcOEt 4:1). The first three fractions (ca. 125 mL each) contained the pure amine (7.93 g). Impurities were left behind. Careful distillation in a short path apparatus gave the pure amine as colorless liquid (7.5 g, 82%).

bp 100 °C /0.2 mmHg, 121 °C /1 mmHg, 99.5% pure (GC),

[α]²⁵_D -96.8 (c 1.25, MeOH).

¹H-NMR: 7.45-7.22 (m, 5H), 3.71, (dd, J₁=11 Hz, J₂=4 Hz, 1H), 2.65-2.45 (m, 2H), 2.45-2.16 (m, 7H), 1.71-1.42 (m, 6H), 0.96 (s, 9H).

(R)-1-[2-(2,2-Dimethylpropyl)amino-2-phenylethyl]-4-methylpiperazine (ref 157)

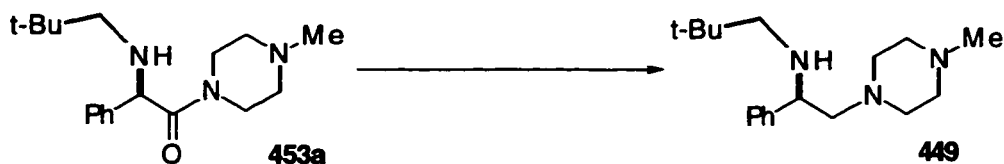

This product was prepared by a procedure analogous to the one given for previous experiment.

Purification: Crystallization of the trihydrochloride from EtOH, and conversion to the free amine with NaOH gave a white solid. The amine was distilled on Kugelrohr (ot 175-200 °C/25 mmHg) since it easily solidifies.

$[\alpha]^{25}_{\text{D}} -19.1$ (c 1.09, EtOH) (hydrochloride)

mp (hydrochloride) 235 °C

$^1\text{H-NMR}$: 7.48-7.22 (m, 5H), 3.72, (dd, $J_1=11$ Hz, $J_2=3.5$ Hz, 1H), 2.80-2.33 (m, 8H), 2.32-2.18 (m, 2H), 2.35 (s, 3H), 0.98 (s, 9H).

mp 80-82 °C, lit.¹⁵⁷ mp 78.5-80 °C

$[\alpha]^{25}_{\text{D}} -93.9$ (c 1.24, MeOH).

$[\alpha]^{25}_{\text{D}} -106$ (c 1.10, CHCl_3) lit. ¹⁵⁷ $[\alpha]^{25}_{\text{D}} -104$ (c 1.18, CHCl_3).

2.3. Procedure for measurement of enantioselectivity of deprotonation of tropinone via acylation reaction

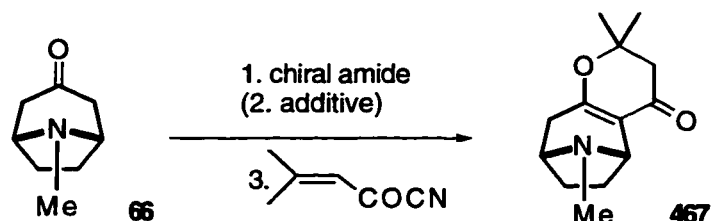

A solution of n-BuLi in hexane (2.0 M, 0.30 mL, 0.6 mmol) was added to a solution of the chiral amine (0.55-0.60 mmol) in THF (2 mL) at 0 °C, and the mixture was stirred for 45 min. A solution of the additive (e.g., lithium chloride in THF) was added and the mixture was stirred for 15 minutes. After cooling to -78 °C, tropinone (0.070 g, 0.50 mmol) in THF (0.7 mL) was added at a controlled speed (typically 0.5 mL/min) and resulting solution was stirred for 150 minutes. Seneciroyl cyanide (0.10 mL, 0.14 g, 1.3 mmol) was then added, and the mixture was stirred at -78 °C for 30 min, followed by quenching with 40% K₂CO₃ (4 mL). After warming to rt the reaction mixture was extracted with ether (30 mL). The extract was dried (MgSO₄) and the solvent was removed under vacuum to give the crude product, which was refluxed for 1 h in ethanol (4 mL) with anhydrous sodium carbonate (0.1 g). After the solvent was removed under vacuum and the carbonate was filtered off (Et₂O), the mixture of the crude product was subjected to chromatographic purification (1:1 hexane/AcOEt, 1:9 MeOH/CH₂Cl₂). A solution of the purified product (1 mg/1 mL of 1:1 MeOH/water) was used in the analysis of enantiomeric excess by HPLC.

The levorotatory isomer of **467** had a shorter retention time (ca. 7 min) than the dextrorotatory enantiomer (ca. 9 min).

2.4. Procedure for measurement of enantioselectivity of deprotonation of tropinone via aldol reaction

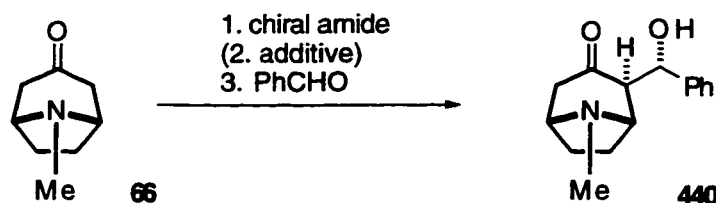

A solution of *n*-BuLi in hexane (2.0 M, 0.30 mL, 0.6 mmol) was added to a solution of the chiral amine (0.55-0.60 mmol) in THF (2 mL) at 0 °C and the mixture was stirred for 45 min. the additive (e.g., lithium chloride solution in THF) was added and the mixture was stirred for 15 minutes. After cooling to -78 °C, tropinone (0.070 g, 0.50 mmol) in THF (0.7 mL) was added at a controlled speed (typically 0.5 mL/min) and the resulting solution was stirred for 150 minutes. Benzaldehyde (0.065 mL, 0.068 g, 0.65 mmol) was then added (fast), and the mixture was stirred at -78 °C for 10 min followed by quenching with saturated aqueous NH₄Cl (5 mL). The reaction mixture was warmed up to rt and extracted with ether (2 x 15 mL). The combined extracts were dried (MgSO₄), the solvent was removed under vacuum and the residue was placed in a vacuum desiccator (over P₂O₅) for 12h to remove unreacted benzaldehyde and most of the chiral amine. The resulting semisolid residue was dissolved in CDCl₃ (0.5 mL). An aliquot of this solution (typically 0.1 mL) was used in the NMR measurement of the ee of the aldol product.

In ¹H-NMR of the product, the doublet at 5.23 ppm split in the presence of 10-20 mg of *S*-(+)-2,2,2-trifluoro-1-(9-anthryl)ethanol into two distinct doublets, usually found between 5.2 and 4.9 ppm. The doublet for the (+)-aldol was observed downfield from the corresponding signal of its enantiomer.

2.5. Procedure for recovering and purification of chiral solvating agent (S)-(+)-TFAE

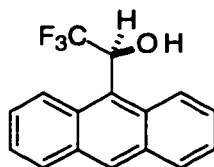

Solvents were removed from ca 20 collected NMR samples containing (S)-(+)-TFAE. The residue was taken up in CH₂Cl₂ (ca 10 mL) and evaporated to dryness with flash silicagel (5-10 g). The dry residue absorbed on the silicagel was applied on DFC column. Elution of the column (0-10% AcOEt in hexane) gave (S)-(+)-TFAE as an oil which crystallized after treating with hexane. The crystals were washed with hexane (2 x 6 mL) and dried under vacuum. The yellowish solid was obtained (0.200 g), which was ready to use in NMR analysis of enantiomeric excess.

R_f = 0.50 (9:1 hexane/AcOEt), strong fluorescence in UV light

[α]²⁵_D +29.3 (c 6.3, CHCl₃), lit.¹⁶⁴ [α]²⁵_D +29 (c 6.3, CHCl₃)

mp 133-134 °C, lit.¹⁶⁴132-135 °C

3. Syntheses

3.1. Generation of Lithium Tropinone Enolate

Method A: Generation of Racemic Tropinone Lithium Enolate using LDA

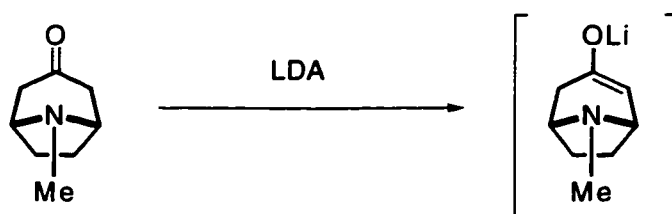

A solution of n-BuLi in hexane (2.0 M, 0.55 mL, 1.1 mmol) was added to diisopropylamine (0.15 mL, 1.1 mmol) in THF (4 mL) at 0 °C and the resulting solution was stirred for 25 min. After cooling to -78 °C, tropinone (0.139 g, 1 mmol) in THF (1 mL) was added dropwise and the resulting mixture was stirred for 45 min.

Method B: Generation of Nonracemic Tropinone Lithium Enolate Using a Lithium Amide Prepared from the Bidentate Amine

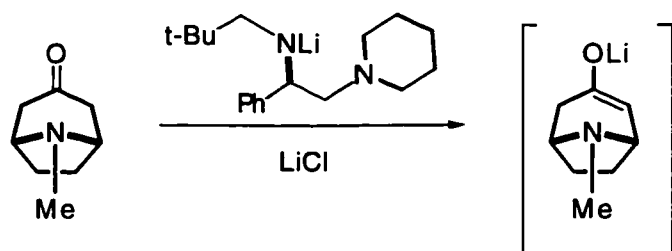

A solution of *n*-BuLi in hexane (2.0 M, 0.60 mL, 1.2 mmol) was added to a solution of (*R*)-1-[2-(2,2-dimethylpropyl)amino-2-phenylethyl]piperidine (0.329 g, 1.2 mmol) in THF (5 mL) at 0 °C and the mixture was stirred for 45 min. Lithium chloride in THF (0.50 M, 0.96 mL, 0.48 mmol) was added and stirred for 15 minutes. After cooling to -78 °C, tropinone (0.139 g, 1 mmol) in THF (1 mL) was added dropwise and resulting solution was stirred for 165 minutes.

Method C: Generation of Nonracemic Tropinone Lithium Enolate Using Chiral Amine Hydrochloride

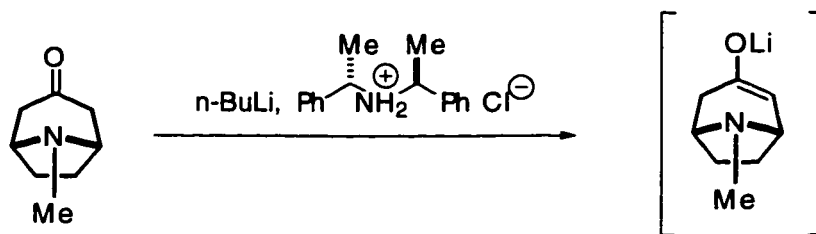

A solution of *n*-BuLi in hexane (2.49 M, 7.12 mL, 17.7 mmol) was added to a suspension of (*S,S*)-(-)-*N,N*-bis(1-phenylethyl)amine hydrochloride (2.307 g, 8.80 mmol) in THF (80 mL) at 0 °C and the mixture was stirred for 45 min. After cooling to -78 °C for 20 min, tropinone (1.112 g, 8 mmol) in THF (8 mL) was added *via* a syringe pump (over 105 min) and the resulting solution was stirred for 120 minutes.

3.2. Synthesis of *ent*-anhydroecgonine methyl ester

(-)-2-Methoxycarbonyltropinone (ref 119)

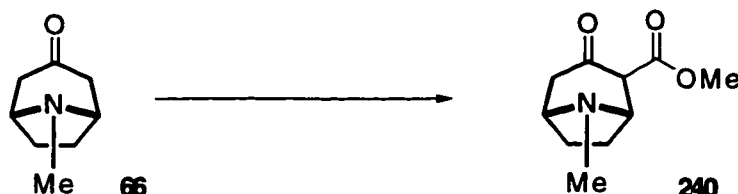

Methyl cyanofornate (0.12 mL, 0.129 g, 1.5 mmol) was added quickly to a solution of nonracemic lithium tropinone enolate (1 mmol, *method B*) and the mixture was stirred at $-78\text{ }^{\circ}\text{C}$ for 30 min, followed by quenching with a solution of AgNO_3 (0.17 g, 1 mmol) in THF (1 mL), water (0.25 mL) and AcOH (0.25 mL). Immediately after bringing the reaction mixture to rt it was basified with NH_3 aq (to pH=8), diluted with water and extracted with chloroform (4 x 10 mL). The combined extracts were dried (MgSO_4), the solvent was removed under vacuum and the residue was subjected to FCC on silica gel deactivated with triethylamine (50% AcOEt in hexane followed by 10% MeOH in CH_2Cl_2 ; 10% for TLC). A white crystalline product was obtained (0.175 g, 89%, easily sublimes at rt).

$[\alpha]^{25}_{\text{D}} -16.4$ (c 1.06, MeOH), 92% ee by ^1H NMR with (S)-(+)-TFAE

lit.¹¹⁶opt. pure $[\alpha]^{18}_{\text{D}} -20.2$ (c 1, MeOH), lit.¹¹⁹ $[\alpha]^{20}_{\text{D}} -18.3$ (c 1, MeOH),

mp 102-104 $^{\circ}\text{C}$ (subl.), lit.¹⁰¹ mp 104-105 $^{\circ}\text{C}$

mp (racemic) 102-103 $^{\circ}\text{C}$ (subl.), lit.¹³¹ mp 103-105 $^{\circ}\text{C}$, mmp 97-101 $^{\circ}\text{C}$

$^1\text{H-NMR}$: (major tautomer) 3.82-3.77 (m, 1H), 3.77 (s, 3H), 3.40-3.35 (m, 1H), 2.80-2.70 (m, 1H), 2.38 (s, 3H), 2.28-2.05 (m, 4H), 1.95-1.75 (m, 1H), 1.65-1.50 (m, 1H).

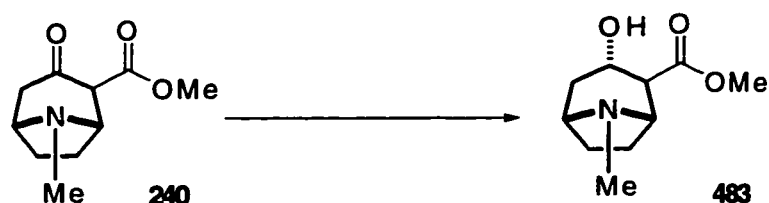
(+)-2-Methoxycarbonyltropine (ref 101)

(-)-2-Methoxycarbonyltropinone **240** (0.197 g, 1 mmol) was dissolved in absolute ethanol (12 mL) and hydrogenated over PtO₂ catalyst (8 mg) at 50 psi for 4 days. When TLC (10% MeOH in CH₂Cl₂) showed almost complete conversion, the catalyst was filtered off on Celite and the solvent was removed under vacuum. Purification of the residue by SCC (10% MeOH-CH₂Cl₂ followed by MeOH-CHCl₃ 1:1) gave colorless oil (0.179 g, 90%).

$[\alpha]^{25}_{\text{D}}$ +4.5 (c 1, MeOH)

$[\alpha]^{25}_{\text{D}}$ +39.3 (c 0.47, CHCl₃), lit.¹⁰¹ $[\alpha]^{20}_{\text{D}}$ +37.7 (c 1, CHCl₃)

mp 73-75 °C (hexane), lit.¹⁰¹ 79-80 °C (hexane)

racemic oil, lit.¹⁶² 72-73 °C

¹H-NMR: 4.29 (t, *J* = 4.5 Hz, 1H), 3.76 (s, 3H), 3.50-3.43 (m, 1H), 3.17-3.10 (m, 1H), 2.95 (t, *J* = 3.5 Hz, 1H), 2.33 (s, 3H), 2.16-1.94 (m, 5H), 1.85-1.75 (m, 1H).

(+)-*ent*-Anhydroecgonine Methyl Ester (ref 163)

A solution of methoxycarbonyltropine (0.3 g, 1.5 mmol) and a catalytic amount of DMAP (0.003 g) in CH_2Cl_2 (2 mL) and Et_3N (0.6 mL) was cooled to 0 °C. Trifluoroacetic anhydride (0.27 mL, 0.40 g, 1.9 mmol) was added and the reaction mixture was stirred for 40 h at rt. After work-up (aq K_2CO_3) and extraction with CHCl_3 , drying (MgSO_4), and concentration under vacuum, a yellow oil was obtained (0.271g). After purification FCC (3-10% MeOH in CH_2Cl_2) a colorless oil was obtained (0.244 g, 90% yield).

$^1\text{H-NMR}$: 6.85 (t, $J = 3$ Hz, 1H), 3.95 (d, $J = 5$ Hz, 1H), 3.76 (s, 3H), 3.50-3.28 (m, 1H), 2.73 (d br, $J = 20$ Hz, 1H), 2.45 (s, 3H), 2.45-2.20 (m, 2H), 2.00-1.88 (m, 2H), 1.65-1.50 (m, 1H).

$[\alpha]_{\text{D}}^{25} +40.5$ (c 1.50, MeOH), 93% ee by $^1\text{H NMR}$ with *S*-(+)-TFAE
lit.¹⁶³ opt. pure prepared from (–)-cocaine $[\alpha]_{\text{D}} -43$ (c 1.5, MeOH)

3.3. Synthesis of both enantiomers of chalcostrobamine *ent*-darlingine and *ent*-isobellendine

General Procedure for Preparation of Acyl Cyanides ^{171,172}

Acyl chloride (20 mmol) was added to a stirred suspension of copper (I) cyanide (4.0 g, 45 mmol) in dry acetonitrile (18 mL) and the mixture was refluxed under argon for 15 min (the solid dissolved and the mixture turned brown). The reaction mixture was then cooled to rt and most of the solvent was removed under vacuum at 25 °C.

The residue was suspended in dry benzene, filtered and the solid was washed with dry benzene (2 x 10 mL). Benzene was removed under vacuum at 25° C and the residue was distilled under vacuum (water aspirator) to give the product.

4-Methyl-2-oxo-3-pentenenitrile (senecieryl cyanide), yield 1.53 g (70%).

bp 65-69 °C/20 mmHg, lit.¹⁷² 68-70 °C/20 mmHg

NMR: 6.23 (m, $J = 1.5$ Hz, 1H), 2.30 (d, $J = 1.5$ Hz, 3H), 2.08 (d, $J = 1.5$ Hz, 3H).

2-Oxo-3-pentenenitrile (crotonyl cyanide), yield 1.1 g (65%).

bp 45-50 °C/18 mmHg, lit.¹⁷² 57-60 °C/20 mmHg

NMR: 7.47 (dq, $J = 7$ Hz, $J = 15$ Hz, 1H), 6.30 (d, $J = 15$ Hz, 2H), 2.15 (d, $J = 7$ Hz, 3H).

IR: 2223 (CN), 1683 (C=O), 1636 (C=C) cm^{-1} .

(E)-3-Methyl-2-oxo-3-pentenenitrile (tigloyl cyanide), yield 1.3 g (60%).

bp 64-69 °C/20 mmHg, lit.¹⁷¹ 70-80 °C/20 mmHg

NMR: 7.39 (qq, $J = 1$ Hz, $J = 7$ Hz, 1H), 2.10 (dq, $J = 1$ Hz, $J = 7$ Hz, 3H), 1.85 (m, $J = 1$ Hz, 3H).

(E)-4-Phenyl-2-oxo-3-butenenitrile (cinnamoyl cyanide), yield 2.82 g (90%).

This compound was purified not by distillation but by passing the chloroform solution through a silica column.

mp 110-112 °C, lit.¹⁷¹ 115 °C

NMR: 7.98 (d, $J = 16$ Hz, 1H), 7.70-7.40 (m, 5H), 6.84 (d, $J = 16$ Hz, 1H).

3-Bromo-2-oxo-3-pentenenitrile (2-bromo-2-butenoyl cyanide)

Bromine (5 mL, 15 g, 94 mmol) was added to crotonyl cyanide (9.0 g, 95 mmol) dissolved in chloroform (3 mL) at 0 °C. The solvent was removed under vacuum and silica gel (1 g) was added to the residues. The resulting mixture was refluxed for 30 min under reduce pressure at 140 °C (water aspirator with bleed). Distillation of the resulting material under vacuum gave a liquid (12.4 g, 75%)

bp 75-80 °C/20 mmHg

NMR: 7.93 (q, $J = 8$ Hz, 1H), 2.25 (d, $J = 8$ Hz, 3H).

IR: 2225 (CN), 1680 (C=O), 1620 (C=C) cm^{-1} .

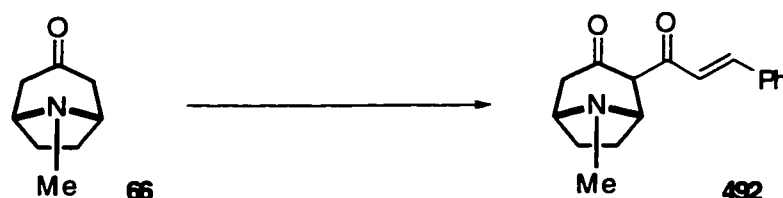
(-)-*ent*-Chalcostrobamine (ref 89)

Cinnamoyl cyanide (0.172 g, 1.1 mmol) in THF (1.5 mL) was added (fast) to a solution of nonracemic lithium tropinone enolate (1 mmol, *method B*) and the mixture was stirred at $-78\text{ }^{\circ}\text{C}$ for 30 min followed by quenching with 40% K_2CO_3 (4 mL). After warming to rt the reaction mixture was extracted with chloroform (3 x 10 mL). The combined extracts were dried (MgSO_4), and the solvent was removed under vacuum to give the crude product. Purification of the product *via* FCC on silica gel deactivated with triethylamine (50% AcOEt in hexane followed by 10% MeOH in CH_2Cl_2 ; 10% for TLC) gave a yellowish oil (0.200 g, 73%).

$[\alpha]_{\text{D}}^{25} -179.0$ (c 1.04, CHCl_3), lit.^{89b} $[\alpha]_{\text{D}}^{20} +12$ (CHCl_3)

$[\alpha]_{\text{D}}^{25} -110.9$ (c 1.05, MeOH), 95% ee by ^1H NMR with (*S*)-(+)-TFAE

$^1\text{H-NMR}$: 7.67 (d, $J = 15.5$ Hz, 1H), 7.55(d, $J = 6.5$ Hz, 1H), 7.33 (m, 2H), 6.81 (d, $J = 15.5$ Hz, 1H), 4.03 (d, $J = 5$ Hz, 1H), 3.40 (t, $J = 5$ Hz, 1H), 2.84 (dd, $J = 19$ Hz, $J = 3$ Hz, 1H), 2.41 (s, 3H), 2.34-2.20 (m, 2H), 2.11 (d, $J = 19$ Hz, 1H), 1.84-1.75 (m, 1H), 1.65-1.55 (m, 1H).

The natural enantiomer, (+)-Chalcostrobamine, was prepared from lithium tropinone enolate generated by *method C* (1 mmol scale, 75% yield).

$[\alpha]_{\text{D}}^{25} +165$ (c 1.04, CHCl_3), 92 % ee by ^1H NMR with (*S*)-(+)-TFAE

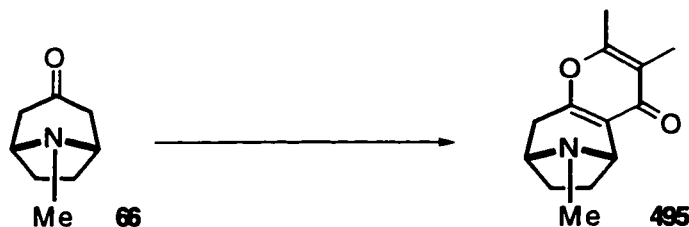
(-)-*ent*-Darlingine (ref 161)

Tigloyl cyanide (0.120 g, 1 mmol) in THF (0.25 mL) was added (fast) to a solution of nonracemic lithium tropinone enolate (1 mmol, *method B*) and the mixture was stirred at $-78\text{ }^{\circ}\text{C}$ for 30 min followed by quenching with 40% K_2CO_3 (4 mL). After warming to rt the reaction mixture was extracted with ether (3 x 10 mL). The combined extracts were dried (MgSO_4) and the solvent was removed under vacuum to give the crude product which was refluxed over 1 h in ethanol (2 mL) with anhydrous sodium carbonate (0.05 g). After the solvent was removed under vacuum and carbonate was filtered off (Et_2O), the mixture of crude product and chiral amine was subjected to FCC on silica gel deactivated with triethylamine (50% AcOEt in hexane followed by 10% MeOH in CH_2Cl_2 10% for TLC). The chromatography gave a mixture of diastereomers of dihydrodarlingine, which was dissolved in ethyl acetate (7 mL) and refluxed with cupric bromide (0.963 g, 4.3 mmol) over 30 h. Triethylamine (5 mL) was added and the reaction mixture was refluxed for 15 min. After the solvents were removed, the residue was treated with aqueous 20% ammonia solution (12 mL) and extracted with chloroform (3 x 15 mL). Extracts were dried (MgSO_4), and the solvent was removed under vacuum to give the crude product which, after purification (passing a chloroform solution through a silica gel column or PTLC in 10% MeOH in CH_2Cl_2) crystallized on standing (0.115 g, 53%).

An analytical sample was crystallized from hexane.

$[\alpha]^{25}_{\text{D}} -45.8$ (c 1.02, MeOH), 91% ee (optical rotation)

lit.¹⁶¹ $[\alpha]^{19}_{\text{D}} +104$ (CHCl₃)

mp 110-111 °C (hexane), lit.¹⁶¹ 160-167 °C, (racemic 109-110 °C)

natural darlingine mp 112-113 °C, $[\alpha]^{25}_{\text{D}} +50.5$ (c 1.02, MeOH)

¹H-NMR: 4.18 (d, $J = 5$ Hz, 1H), 3.48 (m, 1H), 3.02 (dd, $J = 17.5$ Hz, $J = 5$ Hz, 1H), 2.37 (s, 3H), 2.28-2.20 (m, 2H), 2.26 (s, 3H), 1.94 (s, 3H), 2.13 (dd, $J = 17.5$ Hz, $J = 1$ Hz, 1H), 1.88-1.78 (m, 1H), 1.59-1.50 (m, 1H).

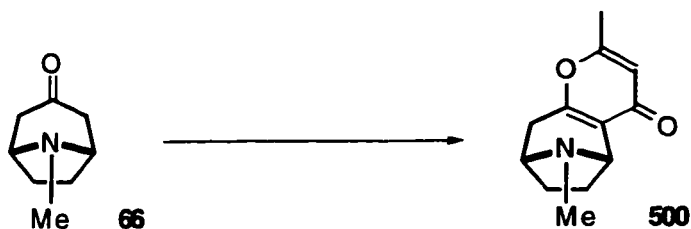
(-)-ent-Isobellendine (ref 87)

2-Bromo-2-butenoyl cyanide (0.174 g, 1 mmol) in THF (1 mL) was added (fast) to a solution of nonracemic lithium tropinone enolate (1 mmol, *method B*) and the mixture was stirred at -78°C for 30 min followed by quenching with 40% K_2CO_3 (4 mL). After warming to rt the reaction mixture was extracted with ether (3x10 mL). The combined extracts were dried (MgSO_4) and the solvent was removed under vacuum to give the crude product which was dissolved in triethylamine (1.5 mL) and refluxed for 3h. The solvent (Et_3N) was then removed under vacuum, the residues were basified with 40% K_2CO_3 (10 mL), and extracted with ether (3 x 10 mL). The combined extracts were dried (MgSO_4). Purification of the residues left after the removal of the solvent from the dried extracts *via* FCC on silica gel deactivated with triethylamine (50% AcOEt in hexane followed by 10% MeOH in CH_2Cl_2 ; 10% for TLC) gave an oil which crystallized on standing (0.023 g, 45%).

$[\alpha]_{\text{D}}^{25} -47.4$ (c 1.01, MeOH), lit.⁸⁷ $[\alpha]_{\text{D}}^{19} +143$, (CHCl_3)

92% ee by ^1H NMR with (*S*)-(+)-TFAE

mp 100-101 $^{\circ}\text{C}$ (hexane), racemic 98-99 $^{\circ}\text{C}$, (hexane) lit.⁸⁷ 114-116 $^{\circ}\text{C}$

^1H -NMR: 6.06 (s, 1H), 4.18 (d, $J = 5$ Hz, 1H), 3.58 (m, 1H), 3.12 (dd, $J = 17$ Hz, $J = 5$ Hz, 1H), 2.41 (s, 3H), 2.35-2.12 (m, 2H), 2.23 (s, 3H), 1.91-1.80 (m, 1H), 1.65-1.51 (m, 1H), 1.48-1.35 (m, 1H).

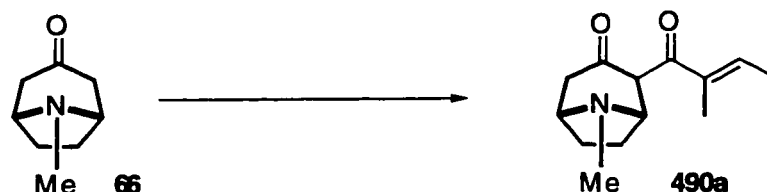
(±)-2-Tigloyltropinone (ref 90)

Tigloyl cyanide (0.120 g, 1 mmol) in THF (1 mL) was added (fast) to lithium tropinone enolate solution (1 mmol, *method A*) and the mixture was stirred at -78 °C for 30 min followed by quenching with 40% K_2CO_3 (4 mL). After warming to rt the reaction mixture was extracted with ether (3 x 10 mL). The combined extracts were dried ($MgSO_4$) and the solvent was removed under vacuum to give the crude product. Purification of the crude product by FCC (50% AcOEt in hexane followed by 10% MeOH in CH_2Cl_2 , 10% for TLC) gave the pure product as an oil (0.177 g, 80%).

1H -NMR: (major enol tautomer) 6.72 (t, $J = 7$ Hz, 1H), 3.80 (s, 1H), 3.25 (t, $J = 5$ Hz, 1H), 2.90-2.68 (m, 2H), 2.45 (s, 3H), 2.40-2.30 (m, 2H), 2.20-2.00 (m, 3H), 1.85 (s, 3H), 1.78 (s, 3H), 1.80-1.60, (m, 1H).

IR: 1649, 1582 cm^{-1} .

Anal. Calcd for $C_{13}H_{19}NO_2$: C, 70.55; H, 8.65; N, 6.33. Found: C, 70.27; H, 8.43; N, 6.58.

(±)-2,3-Dihydrodarlingine (ref 90)

2-Tigloyltropinone (0.160 g, 0.72 mmol) was dissolved in ethanol (10 mL), anhydrous sodium carbonate (0.2 g) was added and the resulting suspension was refluxed for 1 h. The solvent was removed under vacuum, residues were suspended in diethyl ether and filtered through Celite. Removal of ether gave the pure product (0.152 g, 95%).

¹H-NMR: (major isomer) 4.55-4.45 (m, 1H), 4.05-3.90 (m, 1H), 3.40 (s, 1H), 2.82 (s, 1H), 2.35 (s, 3H), 2.30-1.10 (m, 5H), 1.40 (d, $J = 6$ Hz, 3H), 1.09 (d, $J = 6$ Hz, 3H).

IR: 1612 (C=C), 1659 (C=O) cm^{-1} .

MS: (EI) EI) 221 (12), 193 (25), 192 (100), 137 (5), 136 (14), 94 (4), 42 (9).

HRMS: 221.142 (M^+), calcd for $\text{C}_{13}\text{H}_{19}\text{NO}_2$ 221.142.

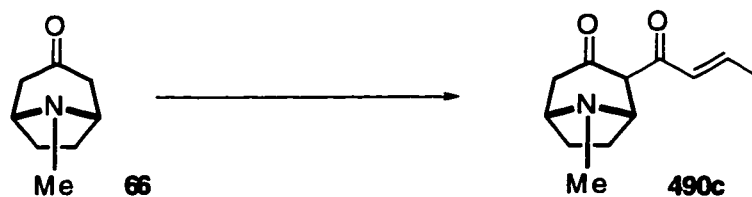
(±)-2-Crotonyltropinone

Crotonyl cyanide (0.105 g, 1.1 mmol) in THF (1 mL) was added (fast) to solution of lithium tropinone enolate (1 mmol, *method A*) and the mixture was stirred at $-78\text{ }^{\circ}\text{C}$ for 30 min followed by quenching with 40% K_2CO_3 (4 mL). After warming to rt the reaction mixture was extracted with ether (3x10 mL). Extracts were dried (MgSO_4) and the solvent was removed under vacuum to give the crude product. Purification by FCC (50% AcOEt in hexane followed by 10% MeOH in CH_2Cl_2 , 10% for TLC) gave the pure product as an oil (0.166 g, 80%).

$^1\text{H-NMR}$: (major enol tautomer) 15.75 (s, 1H), 6.95 (dq, $J = 15\text{ Hz}$, $J = 7\text{ Hz}$, 1H), 6.22 (dq, $J = 15\text{ Hz}$, $J = 1.5\text{ Hz}$, 1H), 3.92 (d, $J = 5\text{ Hz}$, 1H), 3.40 (t, $J = 5\text{ Hz}$, 1H) 2.83 (dd, $J = 19\text{ Hz}$, $J = 5\text{ Hz}$, 1H), 2.40 (s, 3H), 2.35-2.20 (m, 2H), 2.10 (d, $J = 19\text{ Hz}$, 1H) 1.95 (dd, $J = 7\text{ Hz}$, $J = 1.5\text{ Hz}$, 2H), 1.80-1.55 (m, 2H).

IR: 1649, 1590 cm^{-1} .

MS: (EI) 207 (14), 179 (39), 178 (100), 135 (24), 82 (23), 69 (22), 58 (18), 56 (17).

HRMS: 207.127 (M^+), calcd for $\text{C}_{12}\text{H}_{17}\text{NO}_2$ 207.126.

(±)-2,3-Dihydroisobellendine

2-Crotonyltropinone (0.200 g, 0.97 mmol) was dissolved in ethanol (15 mL), anhydrous sodium carbonate (0.2 g) was added and the resulting suspension was refluxed for 1 h. The solvent was removed under vacuum, residues were suspended in diethyl ether and filtered through Celite. Removal of ether gave the pure product (0.190 g, 95%).

¹H-NMR: (major isomer) 4.60-4.40 (m, 1H), 3.99 (d, $J = 3$ Hz, 1H), 3.40-3.30 (m, 1H), 2.83-2.67 (m, 1H), 2.50-2.35 (m, 2H), 2.33 (s, 3H), 2.25-1.45 (m, 5H), 1.42 (d, $J = 6$ Hz, 3H).

IR: 1659 (C=O), 1608 (C=C) cm^{-1} .

MS: (EI) 207 (15), 179 (25), 178 (100), 137 (7), 136 (16), 93 (6), 82 (8), 81 (11).

HRMS: 207.127 (M^+), calcd for $\text{C}_{12}\text{H}_{17}\text{NO}_2$ 207.126.

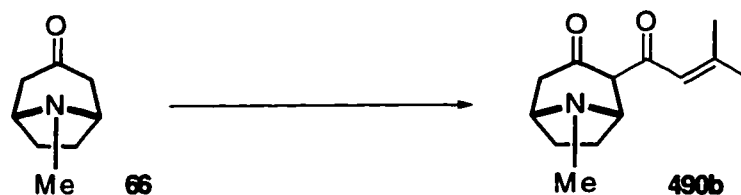
(±)-2-Senecioltropinone

Senecioid cyanide (0.20 mL, 0.28 g, 2.6 mmol) was added to preformed tropinone lithium enolate (1 mmol, *method A*) and the mixture was stirred at $-78\text{ }^{\circ}\text{C}$ for 30 minutes, followed by quenching with 40% K_2CO_3 (4 mL). After warming to rt the reaction mixture was extracted with ether (3 x 10 mL). Extracts were dried (MgSO_4) and the solvent was removed under vacuum to give the crude product (0.337 g) which was purified by FCC (3% MeOH in CH_2Cl_2 , 10% for TLC, $R_f = 0.40$) A yellowish oil was obtained (0.199 g, 90%).

$^1\text{H-NMR}$: 17.25 (br s, 1H, enol form), 5.93 (s, 1H), 3.85 (d, $J = 5\text{ Hz}$, 1H), 3.38 (t, $J = 5\text{ Hz}$, 1H), 2.82 (dd, $J = 5\text{ Hz}$, $J = 18.5\text{ Hz}$, 1H), 2.40 (s, 3H), 2.23-2.20 (m, 2H), 2.17 (s, 3H), 2.05 (d, $J = 18.5\text{ Hz}$, 1H), 1.95 (s, 3H), 1.75 (t, $J = 10\text{ Hz}$, 1H), 1.60 (t, $J = 10\text{ Hz}$, 1H).

$^{13}\text{C-NMR}$: 189.6, 181.1, 154.1, 116.8, 111.9, 58.4, 57.2, 38.7, 36.6, 33.1, 28.7, 28.1, 20.8.

IR: 1650, 1591, 1569 cm^{-1} .

MS: (EI) 221 (27), 194 (6), 193 (50), 192 (100), 191 (6), 137 (24), 136 (37), 110 (8).

Anal. Calcd for $\text{C}_{13}\text{H}_{19}\text{O}_2\text{N}$: C, 70.55; H, 8.65; N, 6.33. Found: C, 70.33; H, 8.69; N, 6.21.

(±)-11,11-Dimethyl-10,11-dihydropyrantropane-3-one

2-Seneciolytropinone (0.199 g, 0.90 mmol) was dissolved in ethanol (8 mL), anhydrous sodium carbonate (0.2 g) was added and the resulting suspension was refluxed for 1 h. The solvent was removed under vacuum, residues were suspended in diethyl ether and filtered through Celite. Removal of ether gave the pure product (0.197 g, 99%).

$R_f = 0.35$ (10% MeOH in CH_2Cl_2)

$^1\text{H-NMR}$: 4.03 (d, $J = 5$ Hz, 1H), 3.39 (t, $J = 5$ Hz, 1H), 2.71 (dd, 5 Hz, 12 Hz, 1H), 2.50 (q, $J = 18.5$ Hz, 2H), 2.34 (s, 3H), 2.20-2.15 (m, 2H), 1.88 (d, 18.5 Hz, 1H), 1.77-1.68 (m, 1H), 1.57-1.51 (m, 1H), 1.44 (s, 3H), 1.41 (s, 3H).

$^{13}\text{C-NMR}$: 189.6, 166.4, 114.1, 80.0, 57.6, 54.9, 47.0, 36.6, 34.7, 33.0, 28.7, 27.0, 25.0.

IR: 1659 (C=O), 1609 (C=C) cm^{-1} .

MS: 221 (18), 193 (29), 192 (100), 136 (24), 135 (20), 81 (18), 56 (10).

Anal. Calcd for $\text{C}_{13}\text{H}_{19}\text{O}_2\text{N}$: C, 70.55; H, 8.65; N, 6.33. Found: C, 70.39; H, 8.68; N, 6.17.

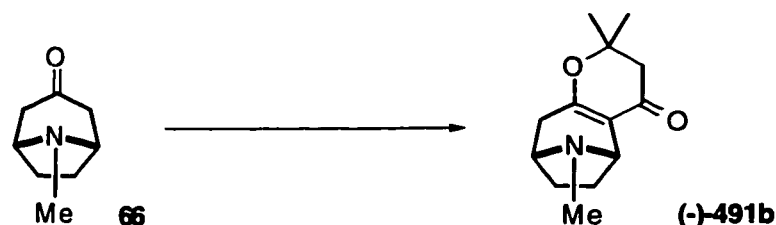
(-)-11,11-Dimethyl-10,11-dihydropyranotropane-3-one

Senecioid cyanide (0.20 mL, 0.28 g, 2.6 mmol) was added to nonracemic lithium tropinone enolate (1 mmol, *method B*) and the mixture was stirred at $-78\text{ }^{\circ}\text{C}$ for 30 min followed by quenching with 40% K_2CO_3 (4 mL). After warming to rt the reaction mixture was extracted with ether (3x10 mL). The extracts were dried (MgSO_4) and the solvent was removed under vacuum to give the crude product which was refluxed over 1 h in ethanol (2 mL) with anhydrous sodium carbonate (0.2 g). After the solvent was removed under vacuum and the carbonate was filtered off (Et_2O), the mixture of the crude product and the chiral amine was subjected to FCC on silica gel deactivated with triethylamine (50% AcOEt in hexane followed by 10% MeOH in CH_2Cl_2 ; 10% for TLC). The chromatography gave the chiral amine (0.312 g, 95% recovery) and the product as a yellowish oil (0.199 g, 90%).

$[\alpha]_{\text{D}}^{25}$ -35.1 (c 1.02, MeOH), 93% ee by HPLC .

3.4. Synthesis of *ent*-knightinol

(+)-(1*S*,2*R*,1'*S*)-2-(1'-Hydroxybenzyl)-8-methyl-8-azabicyclo[3.2.1.]octane-3-one (ref 13)

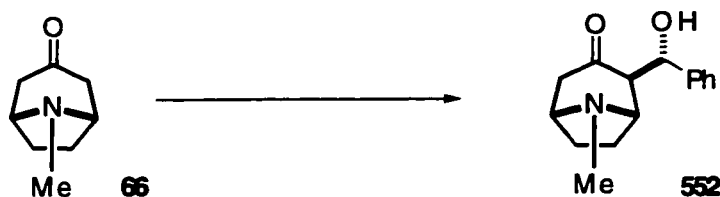

Benzaldehyde (0.13 mL, 0.136 g, 1.28 mmol) was added (fast) to a solution of nonracemic lithium tropinone enolate (1 mmol, *method B*) and the mixture was stirred at $-78\text{ }^{\circ}\text{C}$ for 15 min, followed by quenching with saturated aq NH_4Cl (4 mL). The reaction mixture was warmed up to rt and extracted with ether (4 x 10 mL). The combined extracts were dried (MgSO_4), the solvent was removed under vacuum and the residue was subjected to FCC on silica gel deactivated with Et_3N (50% AcOEt in hexane followed by 10% MeOH in CH_2Cl_2 ; 10% for TLC). Alternative purification: The crude product was dissolved in CH_2Cl_2 (0.5-1 mL) and the solution was diluted with hexane (20 mL), which caused the product to precipitate. The precipitated product was washed with hexane (2 x 10 mL) and dried under vacuum. A white solid was obtained (0.223 g, 91% yield).

$[\alpha]_{\text{D}}^{25} + 30$ (c 0.50, CHCl_3), lit.¹³ $[\alpha]_{\text{D}}^{20} + 23$ (c 0.0173, CHCl_3)

$[\alpha]_{\text{D}}^{25} + 19.7$ (c 1.20, MeOH), 93% ee by ^1H NMR with (*S*)-(+)-TFAE

mp 128-130 $^{\circ}\text{C}$ (Et_2O), lit.¹³ 132-133 $^{\circ}\text{C}$

mp (racemic) 119-121 $^{\circ}\text{C}$ (Et_2O), lit.¹³ 132.7 $^{\circ}\text{C}$

^1H -NMR: 7.42-7.20 (m, 5H), 5.23 (d, $J = 3$ Hz, 1H), 3.60 (d, $J = 6.5$ Hz, 1H), 3.60-3.45 (m, 1H), 2.86 (ddd, $J_1=15.5$ Hz, $J_2=5$ Hz, $J_3=1.5$ Hz, 1H), 2.47 (s, 3H), 2.45-2.41 (m, 1H), 2.32 (ddd, $J_1=15.5$ Hz, $J_2=4$ Hz, $J_3=1.5$ Hz, 1H), 2.35-2.10 (m, 2H), 1.70-1.50 (m, 2H).

exo-2-[(*R*)-*tert*-Butyldimethylsilyloxybenzyl]-8-methyl-8-azabicyclo[3.2.1]octane-3-one

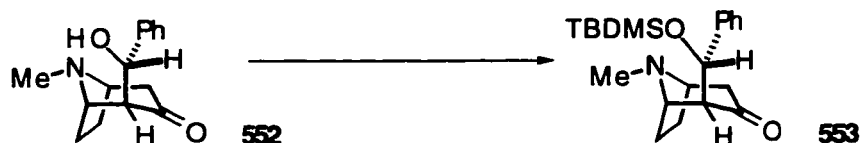

The aldol **552** (0.346 g, 1.41 mmol) was dissolved in dry CH_2Cl_2 (4 mL). DMAP (0.020 g, 0.16 mmol) and dry Et_3N (2 mL) were added, followed by addition of TBDMS chloride (0.420 g, 2.78 mmol). The resulting solution was allowed to stand at rt for 16 hours. The reaction mixture was then diluted with CH_2Cl_2 , shaken with aqueous carbonate solution and extracted with CH_2Cl_2 (3 x 10 mL). The combined organic extracts were dried (MgSO_4), the solvent was removed under vacuum and the residue was subjected to FCC in hexane/AcOEt (9:1) which gave the pure product (0.442 g, 87%).

$[\alpha]^{25}_{\text{D}} + 20.2$ (c 1.10, MeOH)

mp 77-79 °C, (racemic colorless oil)

$^1\text{H-NMR}$: 7.50-7.20 (m, 5H), 5.30 (d, $J = 10$ Hz, 1H), 3.50-3.45 (m, 1H), 2.95-2.80 (m, 1H), 2.70-2.60 (m, 1H), 2.36 (d, $J = 10$ Hz, 1H), 2.25 (s, 3H), 2.00-1.88 (m, 3H), 1.65-1.52 (m, 1H), 1.42-1.30 (m, 1H), 0.80 (s, 9H), -0.05 (s, 3H), -0.30 (s, 3H).

$^{13}\text{C-NMR}$: 208.9, 143.0, 127.9, 127.4, 126.8, 75.0, 68.4, 63.4, 62.8, 48.8, 40.8, 25.5, 25.4, 25.3, 17.7, -4.8 , -5.4 .

IR: 1715 (C=O) cm^{-1} .

MS: (CI- NH_3) 362(6), 361(27), 360 (100), 302 (15), 228(18), 97(13), 83(13), 82(34).

Anal. Calcd for $\text{C}_{21}\text{H}_{33}\text{O}_2\text{NSi}$: C, 70.15; H, 9.25; N, 3.90. Found: C, 69.89; H, 9.19; N, 3.75.

***endo*-2-[(*R*)-*tert*-Butyldimethylsilyloxybenzyl]-8-methyl-8-azabicyclo[3.2.1]octane-3-one**

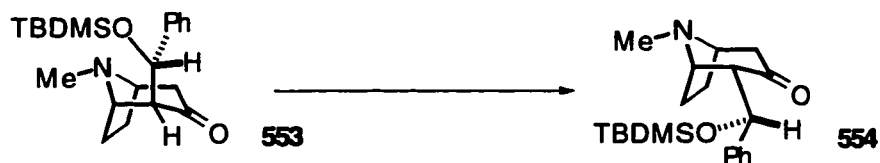

The TBDMS-ether **553** (the *exo,anti*-isomer, 0.420 g, 1.17 mmol) was applied on a flash silica column (10 cm long, $\phi = 4.5$ cm) in hexane/ethyl acetate (9:1) and left for 18 h. The column was washed with hexane/ethyl acetate (1:1) to remove the starting material (0.060 g, 14%) and $\text{CH}_2\text{Cl}_2/\text{MeOH}$ (9:1) to remove the product of isomerization (0.340 g, 81%).

mp (racemic) 52-54 °C

$[\alpha]^{25}_{\text{D}} -88.5$ (c 1.13, MeOH), colorless oil.

$^1\text{H-NMR}$: 7.50-7.20 (m, 5H), 5.12 (d, $J = 7.5$ Hz, 1H), 3.82-3.73 (m, 1H), 3.52-3.43 (m, 1H), 3.12-3.01 (m, 1H), 2.75-2.60 (m, 1H), 2.53 (s, 3H), 2.20-1.18 (m, 4H), 1.68-1.58 (m, 1H), 0.88 (s, 9H), 0.07 (s, 3H), -0.28 (s, 3H).

$^{13}\text{C-NMR}$: 208.0, 144.4, 127.7, 127.2, 127.0, 71.3, 62.9, 61.9, 61.3, 47.6, 37.9, 27.6, 25.7, 24.3, 18.0, -4.7 , -5.3 .

IR: 1710 (C=O) cm^{-1} .

MS: (CI- NH_3) 361 (32), 360 (100), 359 (22), 302 (25), 228 (51), 97 (75), 83 (33), 82 (54).

Anal. Calcd for $\text{C}_{21}\text{H}_{33}\text{O}_2\text{NSi}$: C, 70.15; H, 9.25; N, 3.90. Found: C, 70.23; H, 9.25; N, 3.95.

(-)-endo,endo-2-[(R)-tert-Butyldimethylsilyloxybenzyl]-8-methyl-8-azabicyclo[3.2.1]octane-3-ol

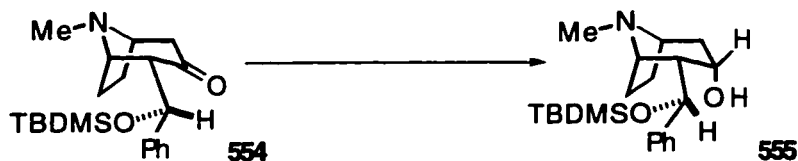

A solution of the TBDMS-ether **554** (the *endo,anti*-isomer, 0.065 g, 0.18 mmol) was hydrogenated in abs EtOH in presence of PtO₂ (0.010g) at 60 psi for 48 h. The catalyst was filtered off on Celite, and the solvent was removed under vacuum. A white solid was obtained (0.066 g, quantitative yield). Note: Scaling up of this procedure was unsuccessful; the reaction did not go to completion.

$[\alpha]_{25}^D -36.0$ (c 1.00, MeOH)

mp 171-172 °C (EtOH). racemic 141-142 °C (EtOH)

¹H-NMR: 7.45-7.20 (m, 5H), 4.79 (d, *J* = 10 Hz, 1H), 3.55-3.48 (m, 1H), 3.37-3.30 (m, 1H), 3.13-3.05 (m, 1H), 2.36 (s, 3H), 2.20-1.87 (m, 5H), 1.58-1.47 (m, 2H), 0.86 (s, 9H), 0.04 (s, 3H), -0.30 (s, 3H).

¹³C-NMR: 143.9, 128.0, 127.3, 127.2, 74.3, 65.3, 61.5, 60.2, 53.2, 40.8, 40.4, 25.8, 25.6, 22.4, 18.1, -4.5, -5.1.

IR: 3168 br (OH) cm⁻¹.

MS (Cl-isobutane) 362 (58), 361 (36), 230 (38), 140 (66), 96 (30), 83 (100), 82 (42), 29 (35).

Anal. Calcd for C₂₁H₃₅O₂NSi: C, 69.75; H, 9.76; N, 3.87. Found: C, 69.61; H, 9.71; N, 3.78.

(-)-endo,endo-2-[[tert-Butyldimethyl)silyloxyphenylmethyl]-8-methyl-8-azabicyclo[3.2.1]octane-3-ol acetate



Acetic anhydride (0.15 mL, 0.208 g, 2 mmol) and DMAP (0.015 g, 0.12 mmol) were added to the solution of alcohol **555** (0.145 g, 0.40 mmol) in Et₃N (1 mL). Some CH₂Cl₂ was added to make the solution clear. After 60 h the solution was treated with aq K₂CO₃ and extracted with CHCl₃ (3 x 10 mL). The combined extracts were dried (MgSO₄), concentrated under vacuum and the residue was subjected to FCC (3% MeOH in CH₂Cl₂ followed by 6% MeOH in CH₂Cl₂). The pure product was obtained (0.156 g, 97%).

[α]_D²⁵ -20.9 (c 1.00, MeOH)

mp 178 °C decomp. (hexane wash), racemic oil

¹H-NMR: 7.32-7.13 (m, 5H), 4.57 (d, *J* = 10 Hz, 1H), 4.19 (t, *J* = 4.5 Hz, 1H), 3.68-3.58 (m, 1H), 3.17-3.08 (m, 1H), 2.40 (s, 3H), 2.30-2.10 (m, 2H), 2.12-1.94 (m, 3H), 2.08 (s, 3H), 1.80-1.55 (m, 2H), 0.85 (s, 9H), 0.03 (s, 3H), -0.30 (s, 3H).

¹³C-NMR: 169.5, 142.2, 128.1, 127.7, 126.8, 73.7, 68.3, 61.5, 59.8, 51.6, 40.5, 36.5, 25.6, 25.5, 21.9, 21.4, 18.0, -4.6, -5.2.

IR: 1739 (C=O) cm⁻¹.

MS (CI-isobutane) 404 (14), 403 (16), 344 (32), 55 (23), 44 (53), 40 (50), 29 (100), 28 (31).

Anal. Calcd for C₂₃H₃₇O₃NSi: C, 68.44; H, 9.24; N, 3.47. Found: C, 68.14; H, 9.31; N, 3.24.

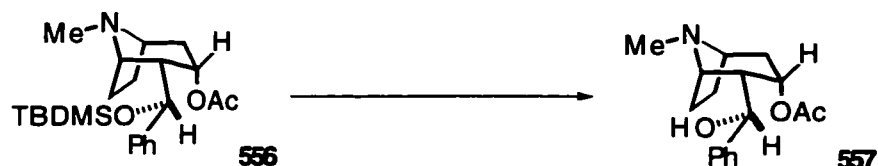
ent-Knightinol (ref 160)

The TBDMS ether **556** (0.085 g, 0.21 mmol) was dissolved in a TBAF solution in THF (1M, 0.5 mL, 0.5 mmol). After standing at rt for 1.5 h the solution was treated with aq K_2CO_3 and was extracted with chloroform (4 x 5 mL). The combined extracts were dried ($MgSO_4$), concentrated under vacuum and quickly purified on a short silica column (10% MeOH in CH_2Cl_2 followed by 1% Et_3N , 10% MeOH in CH_2Cl_2). The colorless product was obtained (0.042 g, 68%).

$[\alpha]^{25}_D -13.0$ (c 1.00, $CHCl_3$), 97% ee by 1H NMR with *S*-(+)-TFAE

lit.¹⁶⁰ $[\alpha]^{20}_D +24$ ($CHCl_3$), natural knightinol $[\alpha]^{25}_D +13.5$ (c 1.00, $CHCl_3$)

racemic: oil

mp 149-151 °C (hexane-acetone), lit.¹⁶⁰153-154 °C

1H -NMR: 7.37-7.23 (m, 5H), 4.65 (d, $J = 10$ Hz, 1H), 4.32 (t, $J = 4.5$ Hz, 1H), 3.94-3.75 (m, 1H), 3.16-3.10 (m, 1H), 2.55-2.45 (m, 1H), 2.36 (s, 3H), 2.40-2.25 (m, 1H), 2.12-1.94 (m, 3H), 2.00 (s, 3H) 1.80-1.60 (m, 2H).

^{13}C -NMR: 169.5, 142.0, 128.7, 128.3, 126.7, 73.2, 68.4, 61.2, 59.7, 50.4, 40.6, 36.7, 25.6, 21.9, 21.3.

IR: 3307 (OH), 1736 (C=O) cm^{-1} .

MS (Cl-isobutane) 290 (59), 289 (52), 272 (60), 231 (31), 230 (100), 84 (29), 83 (35), 82 (55).

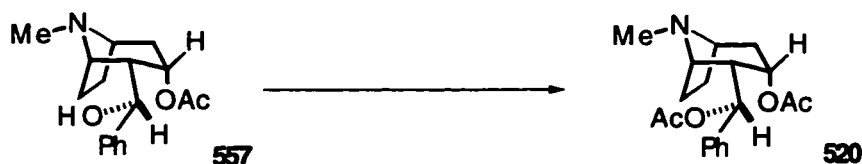
(2*R*',1'*R*')-2 α -(1'-Acetyloxybenzyl)-3 α -(acetyloxy)-tropane

DMAP (0.003 g, 0.024 mmol) and acetic anhydride (0.015 mL, 0.021 g, 0.2 mmol) were added to the solution of *rac*-knightinol (0.029 g, 0.10 mmol) in Et₃N (1 mL). Some CH₂Cl₂ was added to make the solution clear. After 60 h the solution was treated with aq K₂CO₃ and was extracted with CHCl₃ (3 x 10 mL). The combined extracts were dried (MgSO₄), concentrated under vacuum and residue was subjected to FCC (3% MeOH in CH₂Cl₂ followed by 6% MeOH in CH₂Cl₂). The product was obtained as an oil (0.023 g, 70 %).

racemic oil

¹H-NMR: 7.38-7.25 (m, 5H), 5.80 (d, *J* = 11 Hz, 1H), 4.32 (t, *J* = 4.5 Hz, 1H), 3.32-3.24 (m, 1H), 3.18-3.08 (m, 1H), 2.71-2.61 (m, 1H), 2.38 (s, 3H), 2.36-2.26 (m, 1H), 2.12-1.91 (m, 3H), 2.06 (s, 3H), 2.04 (s, 3H) 1.82-1.62 (m, 2H).

¹³C-NMR: 170.3, 169.4, 137.6, 128.6, 128.5, 127.6, 74.7, 67.7, 61.5, 59.9, 48.2, 40.8, 36.7, 25.5, 22.0, 21.3, 21.2.

IR: 1737 (C=O) cm⁻¹.

MS (Cl-isobutane) 332 (14), 331 (9), 273 (20), 272 (100), 82 (15), 61 (17), 57 (85), 43 (85).

3.5. Synthesis of alkaloid KD-B

(+)-Acetyloxybenzyltropinone



Aldol **552** (0.123 g, 0.50 mmol) was dissolved in triethylamine (0.3 mL) and acetic anhydride (0.07 mL, 0.76 g, 0.75 mmol) was added. After standing at rt for 15 hours the reaction mixture was shaken with an aqueous carbonate solution and extracted with CH₂Cl₂ (3 x 10 mL). After the organic extracts were dried and the solvent was removed under vacuum, the pure product was obtained as an oil (0.141 g, 98%). The product was unstable and was slowly undergoing elimination.

$[\alpha]_{\text{D}}^{25}$ -22.7 (c 1.00, MeOH)

¹H-NMR: 7.50-7.30 (m, 5H), 6.45 (d, $J = 10.5$ Hz, 1H), 3.41 (m, 1H), 3.03 (dd, $J_1 = 14.5$ Hz, $J_2 = 6$ Hz, 1H), 2.68 (d, $J = 5$ Hz, 1H), 2.50 (d, $J = 10.5$, 1H), 2.23 (s, 3H), 1.99 (s, 3H), 2.18-1.95 (m, 3H), 1.65-1.25 (m, 2H).

¹³C-NMR: 209.9, 169.9, 138.3, 128.5, 128.4, 127.5, 75.4, 65.0, 63.4, 62.7, 48.8, 41.0, 25.9, 25.8, 20.9.

IR: 1710 (C=O), 1735 (C=O) cm⁻¹.

MS (Cl-NH₃) 289 (27), 288 (100), 229(15), 228 (71), 147(16), 144(16), 140(13), 82(59).

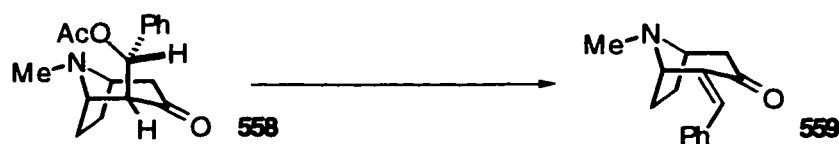
(-)-trans-2-Benzylidotropinone (ref 91a)

Attempted purification of the aldol acetate **558** (0.141 g, 0.49 mmol) on a silica column resulted in complete elimination. The product was taken in CH_2Cl_2 and washed with aqueous carbonate solution. The organic layer was dried (MgSO_4), the solvent was removed under vacuum, and residue was subjected to SCC (hexane/acetate 1:1, 3% $\text{MeOH}/\text{CH}_2\text{Cl}_2$). A yellow oil was obtained (0.095 g, 85%), which was a mixture of two diastereoisomers in a ratio 20:1 as indicated by NMR. It was observed that the ratio was changing after the sample of the product was exposed to light.

$[\alpha]_{\text{D}}^{25}$ -390 (c 1.03, MeOH)

$^1\text{H-NMR}$: 7.60 (s, 1H), 7.45-7.30 (m, 5H), 4.45 (d, $J = 7$ Hz, 1H), 3.65 (t, $J = 6$ Hz, 1H), 2.95 (ddd, $J_1=19$ Hz, $J_2=5.5$ Hz, $J_3=2$ Hz, 1H), 2.46 (s, 3H), 2.60-2.30 (m, 3H), 2.05-1.90 (m, 1H), 1.85-1.70 (m, 1H) .

$^{13}\text{C-NMR}$: 199.2, 139.5, 134.0, 130.0, 128.4, 127.9, 60.8, 58.7, 44.5, 37.1, 30.2, 28.7.

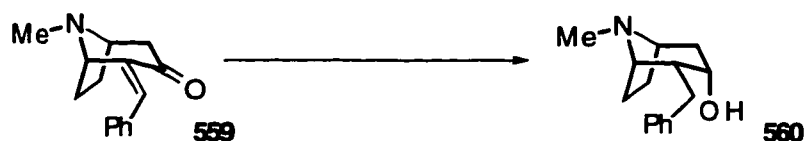
(-)-2-Benzyltropine (ref 91)

(-)-2-Benzylidene-8-methyl-8-azabicyclo[3.2.1]octan-6-one 559 (0.125 g, 0.55 mmol) was dissolved in abs EtOH (6 mL) and was hydrogenated for 48 h at 55 psi with PtO₂ catalyst (0.006 g). After filtering the catalyst off (Celite) and evaporation of the solvent, a white solid was obtained (125 mg, 98%).

mp (racemic) 125-126 °C (ether), lit.^{91c} 123-124 °C

[α]²⁵_D -19.7 (c 1.22, MeOH),

mp 137-138 °C (hexane)

¹H-NMR: 7.31-7.15 (m, 5H), 3.76 (t, *J* = 4.5 Hz, 1H), 3.13 (br s, 1H), 2.87 (dd, *J* = 7 Hz, *J* = 2 Hz, 1H), 2.80 (dd, *J* = 13.5 Hz, *J* = 8.5 Hz, 1H), 2.67 (dd, *J* = 13.5 Hz, *J* = 7.5 Hz, 1H), 2.35-2.22 (m, 1H), 2.27 (s, 1H), 2.14-1.78 (m, 5H), 1.69 (br d, *J* = 14 Hz, 1H).

¹³C-NMR: 140.0, 128.9, 128.2, 125.7, 65.6, 64.0, 60.2, 46.1, 40.2, 39.7, 35.3, 25.2, 21.7.

Alkaloid KD-B (ref 91)

The alcohol **560** (0.058 g, 0.25 mmol), triethylamine (0.5 mL), DMAP (0.005 g), acetic anhydride (0.05 mL) and 5 drops of chloroform (to increase solubility) were kept at rt for 48 h. The solvents were removed under vacuum, the residue was basified (aq K_2CO_3) and extracted with chloroform (3 x 10 mL). After drying and removing the solvent crude product was purified by SCC (3-10% MeOH/ CH_2Cl_2). A colorless oil was obtained (0.061g, 85%).

$[\alpha]^{25}_D +1.40$ (c 1.78, MeOH)

$[\alpha]^{25}_D -13.6$ (c 1.0, $CHCl_3$)

94% ee by 1H NMR with *S*-(+)-TFAE.

1H -NMR: 7.35-7.10 (m, 5H), 4.90 (t, $J = 4.5$ Hz, 1H), 3.20-3.13 (m, 1H), 2.95-2.85 (m, 1H), 2.73-2.53 (m, 2H), 2.30 (s, 3H), 2.50-2.00 (m, 3H), 2.12 (s, 3H), 2.20-1.80 (m, 2H), 1.75 (d, $J = 15$ Hz, 1H), .

^{13}C -NMR: 170.1, 139.1, 128.8, 128.3, 126.0, 69.1, 63.4, 69.9, 45.2, 40.3, 36.8, 35.0, 25.2, 21.5, 21.2.

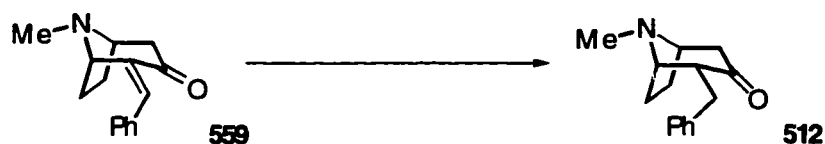
(-)-2-Benzyltropinone

(-)-2-Benzylidene-tropinone **559** (0.014 g, 0.060 mmol) was dissolved in MeOH (2 mL) and was hydrogenated for 2h at 55 psi with Pd/C (30 %, 0.010 g) as the catalyst. After filtering the catalyst off (Celite) and evaporation of solvent colorless oil was obtained (0.0136 g, 96%).

$[\alpha]_D^{25}$ -55.3 (c 1.14, MeOH),

$^1\text{H-NMR}$: (major isomer) 7.30-7.10 (m, 5H), 3.50-3.42 (m, 1H), 3.12 (dd, $J_1=19.5$ Hz, $J_2=4.5$ Hz, 1H), 3.20-3.15 (m, 1H), 3.05-2.95 (m, 1H), 2.84-2.73 (m, 1H), 2.44 (s, 3H), 2.40-2.18 (m, 2H), 2.14-1.53 ((m, 4H).

IR: 1708 (C=O) cm^{-1} .

MS: (EI) EI) 229 (28), 110 (4), 97 (26), 96 (27), 91 (11), 83 (23), 82 (100), 81 (47).

HRMS: 229.147 (M^+), calcd for $\text{C}_{15}\text{H}_{19}\text{NO}$ 229.147.

3.6. Synthesis of (-)-7 β -Acetoxy-3 α -tigloyloxytropone and (+)-3 α ,7 β -diacetoxy-tropone

6-[*N*-(2,2,2-Trichloroethoxy)carbonyl-*N*-methyl]amino-2-cyclohepten-1-one

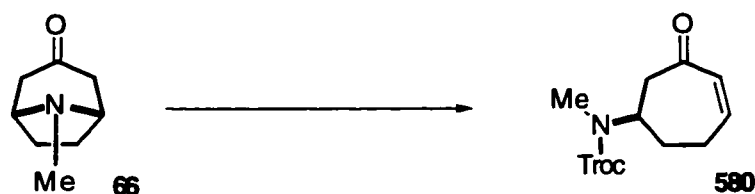

2,2,2-Trichloroethyl chloroformate (0.16 mL, 0.246 g, 1.16 mmol) was added to a solution of tropinone lithium enolate (1 mmol, racemic or scalemic prepared by *method C*) at -78 °C and the mixture was stirred for 30 min. After quenching with 40% K_2CO_3 (4 mL) and warming to rt, the reaction mixture was extracted with ether (3x10 mL). The extracts were washed with 5% H_2SO_4 (to remove the chiral amine, 98% recovery), brine, and were dried ($MgSO_4$). The solvent was removed under vacuum to give the crude scalemic product, which was purified by crystallization from 5 mL of hexane (white solid, 0.289 g, 92%). The chiral amine was left in the mother liquor.

The racemic product was a white solid and was purified by FCC in hexane/ethyl acetate (4:1-1:1).

$R_f = 0.55$ (1:1 hexane/AcOEt)

mp: (racemic) 59-61 °C

mp: (scalemic) 89-90 °C

$[\alpha]_D^{26} +55.4$ (c 1.05, MeOH), second crystallization $+56.5^\circ$ (c 1.04, MeOH)

$^1\text{H NMR}$: 6.64 (ddd, $J = 12$ Hz $J = 6$ Hz, $J = 5$ Hz, 1H), 6.05 (d, $J = 12$ Hz, 1H), 4.75 (s, 2H), 4.55 (br, 1H), 2.90 (s, 3H), 2.92-2.82 (m, 2H), 2.68-2.45 (m, 2H), 2.20-1.90 (m, 2H).

$^{13}\text{C NMR}$:* 200.0, 154.0, 146.4, 132.4, 95.5, 75.0, 51.8, 47.9, 30.6, 29.3, 27.7.

* some signals appeared as two peaks of unequal height due to amide isomerism.

IR: 1713 (C=O), 1666 (C=O) cm^{-1} .

MS: (EI) 315 (4), 313 (4), 124 (29), 108 (100), 109 (38), 82 (59), 81 (31), 80 (20).

Anal. Calcd for $\text{C}_{11}\text{H}_{14}\text{NO}_3\text{Cl}_3$: C, 41.99; H, 4.48; N, 4.45. Found: C, 42.09; H, 4.37; N, 4.26.

(1*R*,6*R*)-6-[*N*-(2,2,2-Trichloroethoxy)carbonyl-*N*-methyl]amino-2-cyclohepten-1-ol

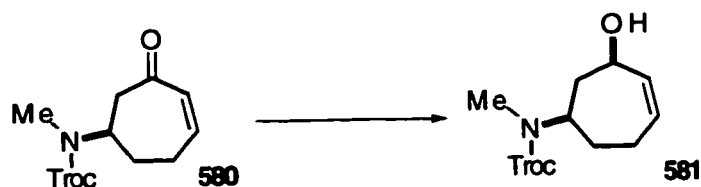

A solution of $\text{CeCl}_3 \cdot 7\text{H}_2\text{O}$ (2.73 g, 7.32 mmol) in MeOH (15 mL) was added to an ice cooled solution of the enone **580** (2.302 g, 7.33 mmol) in MeOH (25 mL). Solid NaBH_4 (0.280 g, 7.37 mmol) was added in small portions to the solution over 45 min. The reaction mixture was warmed up to rt (TLC showed absence of the starting material) and most of the solvent was removed under vacuum. The residue was treated with aqueous K_2CO_3 (2 g in 200 mL) and was extracted with CH_2Cl_2 (3 x 30 mL). The extracts were washed with water, brine, and were dried (MgSO_4). The solvent was removed under vacuum and the crude product (2.293 g, 99%) was used in the next step. An analytical sample was obtained by DFC (4:1 hexane/AcOEt).

colorless oil, $R_f = 0.56$ (1:1 hexane/AcOEt)

$[\alpha]_{\text{D}}^{26} +17.4$ (c 1.32, MeOH)

$^1\text{H NMR}$: 5.82-5.68 (m, 2H), 4.80-4.70 (m, 2H), 4.45-4.38 (m, 1H), 4.30-4.12 (m, 1H), 2.88 (s, 3H), 2.35-2.18 (m, 1H), 2.10-1.68 (m, 4H), 1.62-1.45 (m, 1H).

$^{13}\text{C NMR}$: 153.7, 138.6, 127.7, 95.4, 74.7, 68.1, 55.8, 40.5, 30.2, 28.4, 24.7.

IR: 3453 (OH), 1711 (CO) cm^{-1} .

MS: (EI) 300 (3), 397 (11), 234 (11), 232 (12), 149 (14), 110 (28), 92 (37), 84 (100).

Anal. Calcd: C, 41.72; H, 5.09; N, 4.42. Found: C, 41.97; H, 5.13; N, 4.31.

(1*R*,6*R*)-1-Acetoxy-6-[*N*-(2,2,2-trichloroethoxy)carbonyl]-*N*-methyl]amino-2-cycloheptene

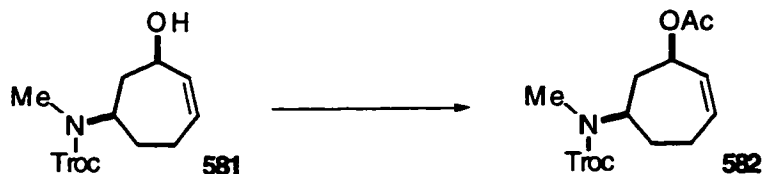

A solution of the allylic alcohol **581** (2.200 g, 6.96 mmol) in CH₂Cl₂ (6 mL) and Et₃N (4 mL) containing DMAP (0.02 g) was cooled to 0 °C. Acetic anhydride (1.0 mL, 10.6 mmol) was added and the reaction mixture was left at rt for 24 h. The reaction mixture was then shaken with aqueous K₂CO₃ (1.5 g in 20 mL) for 20 min, diluted with water (30 mL) and extracted with CH₂Cl₂ (3 x 30 mL). The combined extracts were washed with water (90 mL), dried (MgSO₄) and concentrated under vacuum. The residue was subjected to DFC (5-10% AcOEt/hexane), which gave the pure product as a colorless oil (2.410 g, 97%).

R_f = 0.79 (1:1 hexane/AcOEt)

[α]_D²⁶ +16.7 (c 1.05, MeOH)

¹H NMR: 5.88-5.25 (m, 1H), 5.65 (d, *J* = 12 Hz, 1H), 5.48-5.37 (m, 1H), 4.90-4.68 (m, 2H), 4.45-4.15 (m, 1H), 2.88 (s, 3H), 2.39-2.20 (m, 1H), 2.07 (s, 3H), 2.18-1.72 (m, 4H), 1.68-1.48 (m, 1H).

¹³C NMR: 169.9, 153.8, 134.7, 129.4, 95.8, 75.0, 71.1, 56.2, 37.1, 30.5, 28.9, 24.9, 21.2.

IR: 1714, 1739 cm⁻¹.

MS: (EI) 359 (5), 357 (5), 324 (65), 322 (100), 318 (31), 317 (28), 316 (86), 315 (34), 314 (88).

Anal. Calcd: C, 43.53; H, 5.06; N, 3.90. Found: C, 43.56; H, 5.13; N, 3.92.

(4*R*,6*S*)-4-Acetoxy-6-[*N*-(2,2,2-trichloroethoxy)carbonyl-*N*-methyl]amino-2-cyclohepten-1-one

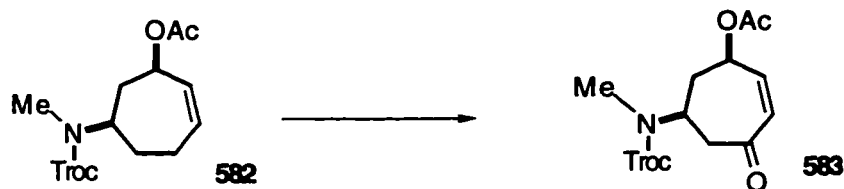

A solution of H_2SeO_3 (0.942 g, 7.32 mmol) in wet dioxane (35 mL dioxane + 0.4 mL water) was added to a stirred mixture of allylic acetate **582** (2.399 g, 6.70 mmol), Celite (9 g) and dioxane (30 mL). The resulting mixture was refluxed with stirring for 18 h, diluted with EtOH (30 mL) and refluxed for a further 10 min. The black mixture was then filtered through Celite and the solvents were removed under vacuum. The residue was dissolved in 10% MeOH/ CH_2Cl_2 and filtered through TLC silica. Solvents were thoroughly removed from the filtrate and the residue was treated with CH_2Cl_2 (45 mL) and PDC (5.64 g, 15 mmol) for 12 h. The reaction mixture was then diluted with Et₂O (100 mL) and filtered through Celite/Florisil. The solvents were removed under vacuum and residue was subjected to DFC (15%-20% AcOEt/hexane) which provided the recovered starting material (0.963 g, 40%), and the product (1.086 g, 44%, 73% yield based on recovered starting material).

colorless oil, $R_f = 0.62$ (1:1 hexane/AcOEt)

$[\alpha]_D^{26} +22.5$ (c 1.52, MeOH)

¹H NMR: 6.48 (dd, $J = 12.5$ Hz $J = 4$ Hz, 1H), 6.03 (dd, $J = 12$ Hz, $J = 4$ Hz, 1H), 5.55 (br d, $J = 12$ Hz, 1H), 4.65 (s, 2H), 4.65-4.50 (m, 1H), 2.87 (s, 3H), 2.98-2.75 (m, 2H), 2.35-2.08 (m, 2H), 2.05 (s, 3H).

^{13}C NMR: 198.3, 169.5, 153.8, 144.9, 131.2, 95.3, 75.0, 69.2, 48.7, 47.5, 36.7, 29.6, 20.8.

IR: 1739, 1715, 1670 cm^{-1} .

MS: (CI-NH₃) 374 (10), 372 (10), 282 (34), 280 (54), 279 (30), 198 (44), 140 (100), 107 (50), 61 (50).

Anal. Calcd: C, 41.90; H, 4.38; N, 3.76. Found: C, 41.77; H, 4.28; N, 3.63.

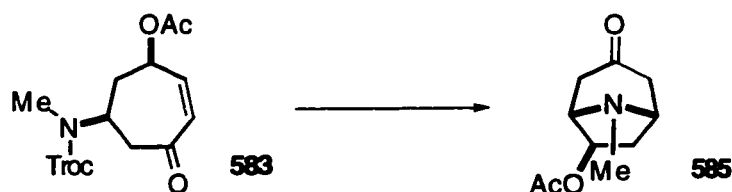
(-)-7 β -Acetoxytropinone (ref 165)

A mixture of the enone **583** (1.030 g, 2.77 mmol) and zinc powder (3.9 g) in 95% EtOH (60 mL) was refluxed for 2h (TLC showed the absence of the starting material). Most of the solvent was removed under vacuum and the residue was treated with 25% NH₃aq (2 mL), CH₂Cl₂ (80 mL), Celite and MgSO₄. The resulting suspension was filtered, the solvent was evaporated under vacuum, and the residue was subjected to DFC (2% MeOH/CH₂Cl₂). A yellowish oil was obtained (0.382 g, 70%). Kugelrohr distillation (ot 120 °C/0.5 mmHg, lit.¹⁶⁵ bp 110 °C/0.03 mmHg) gave the pure product (0.354 g, 65%).

R_f = 0.35 (3% MeOH in CH₂Cl₂), R_f = 0.60 (10% MeOH in CH₂Cl₂)

[α]_D²⁶ -20.2 (c 1.10, MeOH), 95% ee S-(+)-TFAE

¹H NMR: 4.88 (dd, *J* = 4, 6.5 Hz, 1H), 3.60 (br s, 1H), 3.46 (br d, 1H), 2.70 (d, *J* = 5 Hz, 1H), 2.64 (d, *J* = 5 Hz, 1H), 2.60 (s, 3H), 2.30 (d, *J* = 16.5 Hz, 1H), 2.18-2.08 (m, 3H), 2.01 (s, 3H).

¹³C NMR: 206.9, 170.3, 77.6, 65.6, 59.3, 44.2, 42.0, 37.3, 35.8, 20.8.

IR: 1713, 1732 cm⁻¹.

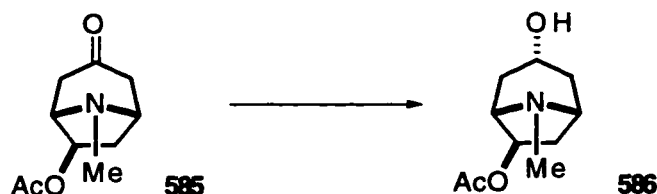
(+)-7 β -Acetoxy-3 α -hydroxytropane (ref 165)

A solution of the ketone **585** (0.298 g, 1.51 mmol) in 95% EtOH (18 mL) with PtO₂ (0.03 g) was hydrogenated in a Paar apparatus at 50 psi and at rt for 12 h. The mixture was filtered through Celite and the solvent was removed under vacuum. A yellowish oil was obtained (0.290 g, 97%). An analytical sample was purified through DFC.

R_f = 0.13 (10% MeOH in CH₂Cl₂)

[α]_D²⁶ +21.3 (c 1.05, MeOH)

¹H NMR: 5.63 (dd, J = 3, 7.5 Hz, 1H), 4.09 (t, J = 5 Hz, 1H), 3.39-3.30 (m, 1H), 3.18 (br s, 1H), 2.90 (br, 1H), 2.74 (dd, J = 7.5, J = 14 Hz, 1H), 2.53 (s, 3H), 2.26-2.03 (m, 3H), 2.06 (s, 3H), 1.79 (d, J = 15 Hz, 1H), 1.58 (d, J = 15 Hz, 1H).

¹³C NMR: 171.0, 79.3, 65.4, 63.5, 59.3, 38.3, 36.0, 35.0, 34.1, 21.2.

IR: 3162, 1733 cm⁻¹.

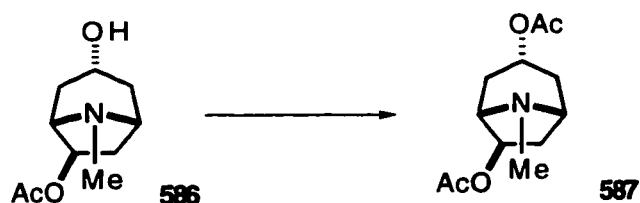
(+)-3 α ,7 β -Diacetoxytropane (ref 145,166)

A solution of the alcohol **586** (0.127 g, 0.638 mmol) in CH_2Cl_2 (0.5 mL) and Et_3N (0.5 mL) containing DMAP (0.005 g) was treated with Ac_2O (0.097 g, 0.95 mmol) and the reaction mixture was left at rt for 24 h. The reaction mixture was then shaken with aqueous K_2CO_3 for 10 min, diluted with water (10 mL) and extracted with CH_2Cl_2 (3 x 15 mL). The extracts were dried (MgSO_4) and evaporated under vacuum. The residue was subjected to DFC (3-6% $\text{MeOH}/\text{CH}_2\text{Cl}_2$), which gave pure the product as a colorless oil (0.143 g, 93%).

$R_f = 0.42$ (10% $\text{MeOH}/\text{CH}_2\text{Cl}_2$)

$[\alpha]_{\text{D}}^{26} +15.5$ (c 1.04 EtOH) lit.¹⁴⁵ $[\alpha]_{\text{D}}$ (enantiomer) -16.1 , 96% optical purity

$^1\text{H NMR}$: 5.45 (dd, $J = 3, 7.5$ Hz, 1H), 5.04 (t, $J = 5$ Hz, 1H), 3.43-3.34 (m, 1H), 3.22 (s br, 1H), 2.57 (dd, $J = 7.5, 14$ Hz, 1H), 2.55 (s, 3H), 2.32-2.05 (m, 3H), 2.09 (s, 3H), 2.08 (s, 3H), 1.83 (d, $J = 15.5$ Hz, 1H), 1.61 (d, $J = 15.5$ Hz, 1H).

$^{13}\text{C NMR}$: 170.4, 169.5, 78.5, 66.4, 64.6, 58.7, 38.0, 35.7, 32.2, 30.6, 21.0, 20.8.

IR: 1734 cm^{-1} .

(-)-7 β -Acetoxy-3 α -tigloyloxytropane (ref 167,168)

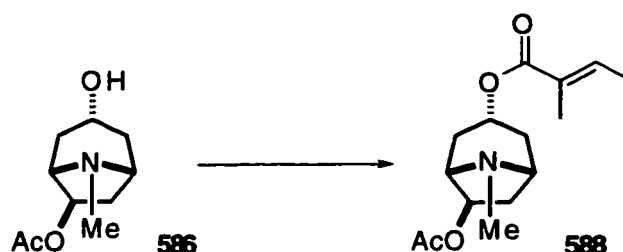

The alcohol **568** (0.100 g, 0.502 mmol) was dissolved in dry pyridine (1.2 mL) and dry benzene (0.6 mL), and treated with DMAP (0.026 g) and Tg₂O (0.2 g, 1.1 mmol) for 3.5 days. The mixture was then diluted with CHCl₃, shaken with aqueous K₂CO₃ solution and extracted with CHCl₃ (3 x 20 mL). The extracts were washed with water, dried (MgSO₄) and solvent was removed under vacuum. The residue was subjected to DFC (1% MeOH/CH₂Cl₂ eluted Tg₂O, 3% eluted the product), which gave the pure product as a colorless oil (0.130 g, 92%).

R_f = 0.47 (10% MeOH/CH₂Cl₂)

[α]_D²⁵ -14.6 (c 2.03, EtOH), lit.¹⁶⁷ [α]_D²⁰ -11.5 (c 12.4, EtOH)

[α]_D²⁵ -9.0 (c 1.55, CHCl₃), lit.¹⁶⁸ [α]_D¹⁹ -13 (CHCl₃)

¹H NMR: 6.91 (tt, *J* = 1, 7 Hz, 1H), 5.50 (dd, *J* = 3, 7.5 Hz, 1H), 5.23 (t, *J* = 5 Hz, 1H), 3.45-3.36 (m, 1H), 3.26 (s br, 1H), 2.63 (dd, *J* = 14, *J* = 7.5 Hz, 1H), 2.57 (s, 3H), 2.36-2.22 (m, 2H), 2.20-2.10 (m, 1H), 2.08 (s, 3H), 1.89 (s, 3H), 1.84 (dd, *J* = 7 Hz, *J* = 1 Hz, 3H), 1.65 (br d, *J* = 15 Hz, 1H).

¹³C NMR: 170.4, 166.5, 137.2, 128.3, 78.5, 66.2, 64.5, 58.8, 38.1, 36.1, 32.4, 30.9, 20.8, 14.1, 11.6.

IR: 1734, 1707, 1650 cm⁻¹.

10-(N-Benzyloxycarbonyl-N-methyl)amino-1,4-dioxaspiro[4,6]undec-6-ene



A mixture of the Cbz-enone **565b** 0.350 g, 1.28 mmol), dry chloroform (15 mL), dry ethylene glycol (0.200 g, 3.22 mmol), and PPTS (0.05 g) was refluxed in a Soxhlet apparatus containing molecular sieves (4A) for 12 h (progress of the reaction was monitored by TLC). When a conversion higher than 50% was achieved the reaction mixture was diluted with hexane (20 mL), filtered through pad of TLC silica gel, and the solvents were removed under vacuum to give a mixture of the desired product, starting material, and some products of decomposition. Chromatographic purification of the residue gave the desired product as an oil (0.171 g, 42%).

$R_f = 0.56$ (1:1 hexane/AcOEt)

$^1\text{H-NMR}$: 7.43-7.27 (m, 5H), 5.95-5.85 (m, 1H), 5.80-5.65 (m, 1H), 5.20-5.18 (m, 2H), 4.80-4.40 (m, 1H), 4.05-3.82 (m, 4H), 2.85 (s, 3H), 2.50-1.60 (m, 6H).

IR: 1698 cm^{-1} .

MS: (EI) 317 (6), 182 (5), 152 (15), 151 (19), 126 (40), 108 (10), 92 (9), 91 (100).

HRMS: 317.162(M^+), calcd for $\text{C}_{18}\text{H}_{23}\text{NO}_4$ 317.163.

10-(N-Benzyloxycarbonyl-N-methyl)amino-7-(2-hydroxy)ethoxy-1,4-dioxaspiro[4,6]undecane



A mixture of the Cbz-enone **565b** (0.500 g, 1.83 mmol), dry chloroform (30 mL), dry ethylene glycol (1.0 g, 16 mmol), and p-TsOH (0.01 g) was refluxed in a Soxhlet apparatus containing molecular sieves (4A) for 12 h. When TLC showed that all starting material was consumed, the reaction mixture was diluted with chloroform (20 mL), filtered through a pad of TLC-grade silica gel, and the solvent was removed under vacuum. Chromatographic purification of the residue gave the acetal product **567b** (0.497 g, 72%).

¹H-NMR: 7.45-7.25 (m, 5H), 5.13 (s, 2H), 4.40-4.12 (m, 1H), 4.00-3.80 (m, 4H), 4.80-3.45 (m, 5H), 2.80 (s, 3H), 2.28-1.62 (m, 9H).

IR: 1697 (C=O) cm⁻¹.

MS: (EI) 379 (5), 266 (5), 244 (26), 182 (8), 159 (48), 149 (24), 127 (13), 91 (100).

HRMS: 379.201 (M⁺), calcd for C₂₀H₂₉NO₆ 379.199.

***cis*-6-(Benzyloxycarbonyl-*N*-methyl)amino-2-cyclohepten-1-ol**

This compound was obtained as a colorless oil in the same way as the Troc derivative **581** (yield 95%).

¹H NMR: 7.50-7.27 (m, 5H), 5.90-5.70 (m, 2H), 5.18 (s, 2H), 4.60-4.05 (m, 2H), 2.83 (s, 3H). 2.35-2.18 (m, 1H), 2.10-1.68 (m, 4H), 1.62-1.45 (m, 1H).

IR: 3460 (OH), 1691 (C=O) cm⁻¹.

MS: (EI) 275 (2), 257 (6), 166 (12), 151 (5), 140 (27), 92 (12), 91 (100), 67 (7).

HRMS: 275.152 (M⁺), calcd for C₁₆H₂₁NO₃ 275.152 .

***cis*-3-[*N*-(2,2,2-Trichloroethoxy)carbonyl-*N*-methyl]amino-1-cycloheptanol**

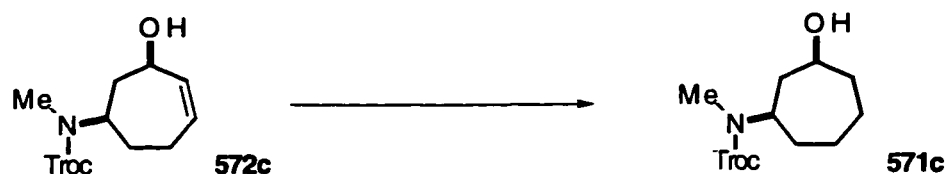

The Troc derivative **572c** (0.214 g, 0.68 mmol) was dissolved in methanol (3 mL) and hydrogenated on 30% Pd/C catalyst (0.02 g) in a Paar apparatus for 2.5 h. The mixture was filtered through Celite and the solvents were removed under vacuum. Purification of the crude product by DFC (10-50% AcOEt in hexane) gave **571c** as a colorless oil (0.134 g, 62%).

¹H-NMR: (major isomer) 4.78-4.60 (m, 2H), 4.28-3.95 (m, 1H), 3.95-3.75 (m, 1H), 2.80 (s, 3H), 2.70 (s, 1H), 2.05-1.35 (m, 10H).

IR: 3443 (OH), 1711 (C=O) cm⁻¹.

MS: (EI) 301 (8), 262 (94), 260 (100), 220 (41), 218 (43), 170 (28), 133 (39), 95 (44).

HRMS: 317.0345 (M⁺), calcd for C₁₁H₁₈NO₃Cl₃ 317.0352.

***cis*-1-Acetoxy-3-[*N*-(2,2,2-trichloroethoxy)methyl]aminocycloheptane**



The Troc derivative **574** (0.403 g, 1.12 mmol) was dissolved in methanol (6 mL) and hydrogenated on 30% Pd/C catalyst (0.02 g) in a Paar apparatus for 2 h. The mixture was filtered through Celite and the solvents were removed under vacuum. Purification of the crude product by DFC (10-50% AcOEt in hexane) gave **579** as a colorless oil (0.267 g, 66%).

¹H-NMR: (major isomer) 5.08-4.90 (m, 1H), 4.89-4.67 (m, 2H), 4.20-4.05 (m, 1H), 2.88 (s, 3H), 2.05 (s, 3H), 2.10-1.45 (m, 10H).

IR: 1713 (C=O) cm⁻¹.

MS: (EI) 262 (68), 260 (70), 257 (60), 245 (62), 243 (64), 170 (76), 168 (100), 95 (71).

HRMS: 359.046 (M⁺), calcd for C₁₃H₂₀NO₄Cl₃ 359.046.

***cis*-1-(1-Methyl-1-methoxy)ethoxy-3-[*N*-(2,2,2-trichloroethoxy)carbonyl-*N*-methyl]aminocycloheptane**

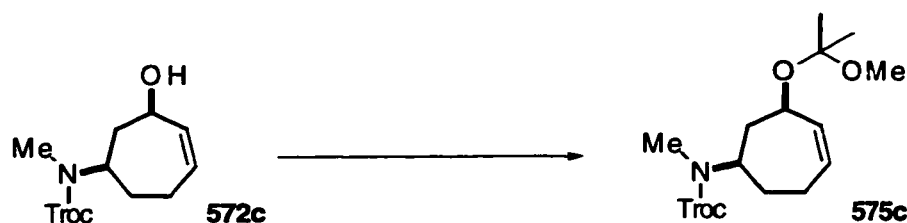

The allylic alcohol **572c** (0.158 g, 0.50 mmol) was dissolved in methyl isopropenyl ether (1 mL). The mixture was cooled in ice, and a trace of POCl₃ was added. The resulting solution was allowed to stand at rt for 1h (TLC showed no starting material). The reaction mixture was then treated with anhydrous Na₂CO₃ (0.2 g), diluted with dry hexane, and subjected to DFC (5-20% AcOEt in hexane), which gave the pure product (0.165 g, 85%).

¹H-NMR: 5.88-5.60 (m, 2H), 4.85-4.65 (m, 2H), 4.48-4.28 (m, 2H), 3.20 (s, 3H), 2.82 (s, 3H), 2.35-1.65 (m, 6H), 1.35 (s, 3H), 1.31 (s, 3H).

IR: 1715 (C=O) cm⁻¹.

MS: (Cl-CH₄) 354 (3), 352 (5), 300 (16), 298 (16), 262 (6), 168 (8), 93 (11), 73 (100).

HRMS: 352.108 (M⁺-Cl), calcd for C₁₅H₂₄NO₄Cl₂ 352.108.

***cis*-1-(*tert*-Butyldimethyl)silyloxy-3-[*N*-(2,2,2-trichloroethoxy)carbonyl-*N*-methyl]aminocycloheptane**

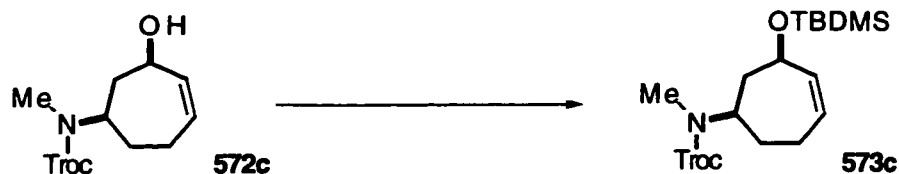

The allylic alcohol **572c** (0.170 g, 0.54 mmol) was dissolved in dry CH₂Cl₂ (5 mL). Dry Et₃N (2 mL) and DMAP (0.020 g, 0.16 mmol) were added followed by TBDMS chloride (0.090 g, 0.60 mmol). The resulting solution was allowed to stand at rt for 12 hours. The reaction mixture was then diluted with CH₂Cl₂, shaken with aqueous carbonate solution and extracted with CH₂Cl₂ (3 x 15 mL). The combined organic extracts were dried (MgSO₄), the solvent was removed under vacuum and the residue was subjected to DFC (2-10% hexane/ethyl acetate) which gave the pure product (0.188 g, 81%).

¹H-NMR: 5.90-5.65 (m, 2H), 4.90-4.65 (m, 2H), 4.50-4.10 (m, 2H), 2.88 (s, 3H), 2.35-1.35 (m, 6H), 0.92 (s, 9H), 0.11 (s, 6H).

IR: 1718 (C=O) cm⁻¹.

MS: (Cl-CH₄) 374 (91), 372 (90), 264 (29), 262 (36), 132 (25), 93 (100), 75 (56), 73 (36).

HRMS: 414.082 (M⁺-CH₃), calcd for C₁₆H₂₇NO₃SiCl₃ 414.082.

(1*R,6*S**)-1-Acetoxy-6-[*N*-(2,2,2-trichloroethoxy)carbonyl-*N*-methyl]amino-2-cyclohepten-4-ol**

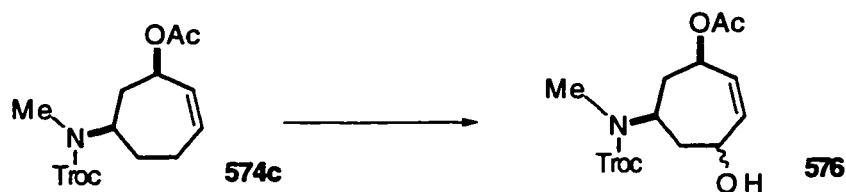

A solution of H_2SeO_3 (0.942 g, 7.32 mmol) in wet dioxane (35 mL dioxane and 0.4 mL water) was added to a stirred mixture of allylic acetate **574c** (2.399 g, 6.70 mmol), Celite (9 g) and dioxane (30 mL). The resulting mixture was refluxed with stirring for 18 h, diluted with EtOH (30 mL) and refluxed for a further 10 min. The black mixture was filtered through Celite, the solvents were removed under vacuum and the residue was subjected to DFC, to give the recovered starting material (15% AcOEt/hexane, 0.816 g, 34%), the enone (35% AcOEt/hexane, 0.299 g, 12%), and the allylic alcohol **576** (50% AcOEt/hexane, 1.047 g, 42%)

$R_f = 0.22$ (1:1 hexane /AcOEt)

$^1\text{H NMR}$: (major isomer) 5.98-5.85 (m, 1H), 5.72 -5.55 (m, 1H), 4.85-4.60 (m, 4H), 4.55-4.35 (m, 1H), 2.93 (s, 3H), 2.08 (s, 3H), 2.22-1.18 (m, 4H).

IR: 3451, 1737, 1713 cm^{-1}

MS: (EI) 109 (24), 108 (100), 100 (16), 84 (24), 82 (25), 81(21), 58 (20), 57 (19).

HRMS: 373.025 (M^+), calcd for $\text{C}_{13}\text{H}_{18}\text{NO}_5\text{Cl}_3$ 373.025.

3.7. Synthesis of physoperuvine

6-(*N*-Benzyloxycarbonyl-*N*-methyl)amino-2-cyclohepten-1-one

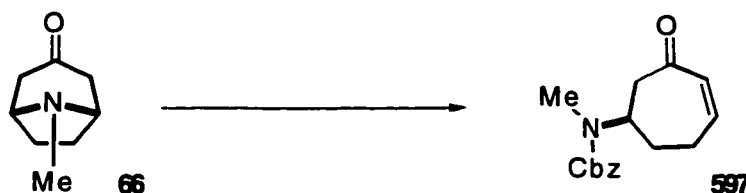

Benzyl chloroformate (0.17 mL, 0.204 g, 1.20 mmol) was added to a solution of tropinone lithium enolate (1 mmol, racemic or scalemic prepared by *method C*) at $-78\text{ }^{\circ}\text{C}$ and the mixture was stirred for 30 min. After quenching with 40% K_2CO_3 (4 mL) and warming to rt, the reaction mixture was extracted with ether (3x10 mL). The extracts were washed with 5% H_2SO_4 (to remove the chiral amine, 98% recovery), brine, and were dried (MgSO_4). The solvent was removed under vacuum to give the crude product which was subjected to chromatographic purification by DFC (5-50% hexane /AcOEt, $R_f = 0.43$ in 1:1 hexane /AcOEt). The product was obtained as a colorless oil (0.232g, 85%).

$[\alpha]_D^{24} +70.0$ (c 1.04, MeOH)

$^1\text{H NMR}$: 7.35-7.20 (m, 5H), 6.64 (ddd, $J = 12\text{ Hz}$, $J = 6\text{ Hz}$, $J = 5\text{ Hz}$, 1H), 6.05 (d, $J = 12\text{ Hz}$, 1H), 5.13 (s, 2H), 4.50 (br, 1H), 2.90-2.80 (m, 2H), 2.85 (s, 3H), 2.65-2.40 (m, 2H), 2.12-1.88 (m, 2H).

$^{13}\text{C NMR}$: 200.2, 155.5, 146.2, 136.5, 132.3, 128.3, 127.8, 127.6, 67.0, 51.2, 48.0, 30.8, 29.2, 27.6.

IR: 1697, 1666 cm^{-1} .

MS: (EI) 273 (1), 167 (22), 138 (23), 110 (20), 107 (11), 92 (21), 91 (100), 65 (17).

Anal. Calcd for $\text{C}_{16}\text{H}_{19}\text{NO}_3$: C, 70.31; H, 7.01; N, 5.12. Found: C, 70.16; H, 7.83; N, 5.07.

(-)-6-(*N*-Benzyloxycarbonyl-*N*-methyl)amino-2,3-epoxycycloheptan-1-one

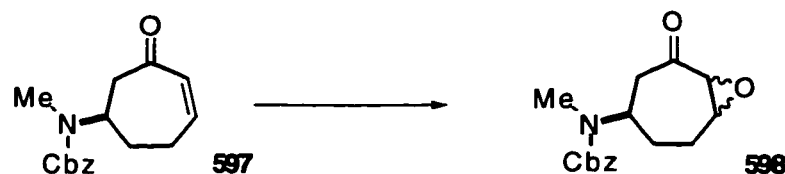

The Cbz derivative **597** (1.215 g, 4.45 mmol) was dissolved in a mixture of THF (20 mL) and water (5 mL), and the solution was cooled to ca. $-10\text{ }^{\circ}\text{C}$ (ice-acetone bath). A hydrogen peroxide solution (30%, 3 mL, 26 mmol), followed by a solution of KOH (0.05 g, 0.9 mmol) in water (2 mL) were added to the stirred mixture. After 5 min the reaction mixture was warmed to rt and was further stirred for 15 min TLC showed absence of the starting material. The reaction mixture was diluted with water (80 mL) and was extracted with CHCl_3 (4 x 40 mL). The extracts were dried (MgSO_4), the solvent was removed under vacuum, and the residue was subjected to DFC. A mixture of two isomeric epoxides (3:1) was obtained (1.20 g, 93%) as a colorless oil (major isomer $R_f = 0.53$, minor isomer $R_f = 0.44$ in 1:1 hexane/AcOEt).

$[\alpha]_{\text{D}}^{24} -48$ (c 1.1, MeOH), major isomer

$^1\text{H NMR}$: 7.43-7.30 (m, 5H), 5.16 (s, 2H), 4.05-3.75 (m, br, 1H), 3.46-3.42 (m, 2H), 3.20 (t, $J = 12\text{ Hz}$, 1H), 2.85 (s, 3H), 2.44-2.40 (m, 1H), 2.34 (d, $J = 10\text{ Hz}$, 1H), 2.28-2.22 (m, 1H), 2.10-1.90 (m, 1H), 1.70-1.60 (m, 1H).

$^{13}\text{C NMR}$: 206.7, 155.0, 136.2, 128.0, 127.6, 127.4, 66.8, 58.8, 55.3, 51.8, 44.2, 28.0, 27.0, 24.3.

IR: 1703 cm^{-1} .

MS: (EI) 289 (4), 146 (30), 111 (9), 92 (100), 83 (12), 65 (11), 57 (11), 55 (7).

HRMS: 289.132 (M^+), calcd for $\text{C}_{16}\text{H}_{19}\text{NO}_4$ 289.131.

(-)-5-(*N*-Benzyloxycarbonyl-*N*-methyl)amino-2-cyclohepten-1-ol

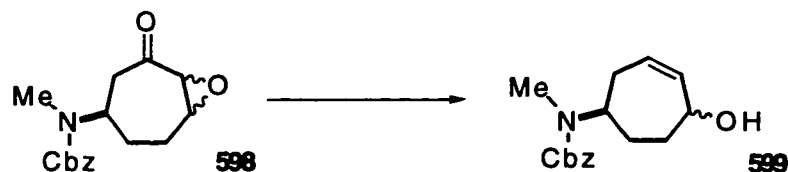

The Cbz-epoxide **598** (1.00 g, 3.46 mmol) was dissolved in dry MeOH and a solution of hydrazine (0.34 g, 10.6 mmol in 5 mL of MeOH dried with molecular sieves 3A) was added at rt with stirring. After addition of glacial AcOH (2 drops), stirring was continued for another 2 h (N₂ evolved and the reaction mixture warmed up slightly). The resulting solution was then diluted with CHCl₃ (25 mL) and was washed with 5% H₂SO₄. The acid washings were extracted with CHCl₃ (3 x 20 mL). The combined extracts were dried (MgSO₄), filtered through a small pad of TLC-grade silica, and the solvent was removed under vacuum. The resulting residue was subjected to DFC (35-50% AcOEt in hexane). A mixture of two isomers was obtained (0.476 g, 50%).

major isomer R_f = 0.32, minor isomer R_f = 0.27 (1:1 hexane/AcOEt)

[α]_D²⁴ -66 (c 1.1, MeOH), major isomer

¹H NMR: 7.40-7.25 (m, 5H), 5.85-5.10 (m, 2H), 5.13 (s, 2H), 4.50-4.10 (m, 1H), 2.80 (s, 3H), 2.52-2.45 (m, 2H), 2.35 (d, *J* = 10 Hz, 1H), 2.20-2.08 (m, 1H), 2.07-1.70 (m, 4H).

¹³C NMR: 155.7, 135.0, 128.3, 127.8, 127.7, 127.6, 124.9, 71.5, 68.5, 66.9, 54.2, 53.7, 35.4, 32.3.

IR: 3415, 1695, 1677 cm⁻¹.

MS: (CI-NH₃) 276 (20), 274 (11), 259 (18), 258 (100), 168 (17), 166 (27), 108 (28), 91 (65).

HRMS: 275.152 (M⁺), calcd for C₁₆H₂₁NO₃ 275.152 .

(5*R*)-5-(*N*-Benzyloxycarbonyl-*N*-methyl)amino-2-cyclohepten-1-one (ref 95)



A solution of the alcohol **599** (0.448 g, 1.63 mmol) in CH_2Cl_2 (25 mL) was treated with PDC (0.94 g, 2.50 mmol) for 12 h at rt. The reaction mixture was diluted with Et_2O (75 mL) and filtered through a pad of Celite and TLC silica (washed with 1:1 hexane/ AcOEt). After removing the solvents the crude product was obtained as a colorless oil (0.400 g, 90%).

$R_f = 0.35$ (1:1 hexane / AcOEt)

$[\alpha]_{\text{D}}^{25} +93$ (c 1.0, MeOH)

$^1\text{H NMR}$: 7.42-7.25 (m, 5H), 6.57 (ddd, $J = 12$ Hz, $J = 6.5$ Hz, $J = 5$ Hz, 1H), 6.07 (d, $J = 12$ Hz, 1H), 5.13 (s, 2H), 4.50 (br, 1H), 2.89 (s, 3H), 2.80-2.53 (m, 4H), 2.09-1.85 (m, 2H).

$^{13}\text{C NMR}$: 201.7, 155.1, 142.2, 136.2, 132.1, 128.0, 127.5, 127.3, 66.6, 54.2, 39.8, 33.3, 29.0, 25.0.

IR: 1693, 1679 cm^{-1} .

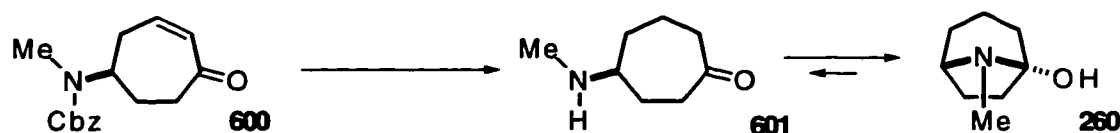
(+)-Physoperuvine (ref 113,114)

A solution of the Cbz-enone **600** (0.340 g, 1.24 mmol) in MeOH (12 mL) was hydrogenated in the presence of 30% Pd/C (0.026 g) over 2h at 30 psi in a Paar apparatus. The mixture was filtered through Celite and the solvent was removed under vacuum to provide an off-white solid (0.163 g, 92%). Analytically pure material was obtained through Kugelrohr sublimation (ot 100-120 °C/0.5 mmHg).

white solid, $R_f = 0.66$ (5:4:1 $\text{CHCl}_3/\text{MeOH}/\text{NH}_3\text{aq}$ 25%)

mp (racemic) 72-73 °C (acetone), lit.^{114a} 75 °C

$[\alpha]_{\text{D}}^{25} +17.9$ (c 1.30, H_2O), 95% ee with (*S*)-(+)- TFAE,

lit.^{114b} $[\alpha]_{\text{D}} +1.2$ (c 1.3, H_2O)

mp (opt. active) 48-50 °C (sublimed), lit.¹¹³ 47-48 °C

¹H NMR: 3.13 (br s, 1H), 2.38 (s, 3H), 2.15-1.87 (m, 4H), 1.82-1.52 (m, 5H), 1.34-1.20 (m, 1H).

IR: 3099 (OH) cm^{-1} .

6-(*N*-Methoxycarbonyl-*N*-methyl)amino-2-cyclohepten-1-one



Methyl chloroformate (0.10 mL, 0.122 g, 1.29 mmol) was added to a solution of tropinone lithium enolate (1 mmol, by *method A*) at $-78\text{ }^{\circ}\text{C}$ and the mixture was stirred for 30 min. After quenching with 40% K_2CO_3 (4 mL) and warming to rt, the reaction mixture was extracted with ether (3x10 mL). The extracts were dried (MgSO_4) and the solvent was removed under vacuum to give the crude product which was subjected to FCC in hexane/ethyl acetate (3:1). The product was obtained as colorless oil (0.181g, 92%).

$R_f = 0.32$ (1:1 hexane /AcOEt)

bp $275\text{ }^{\circ}\text{C}$ (decomposition)

$^1\text{H NMR}$: 6.64 (ddd, $J = 12\text{ Hz}$, $J = 6\text{ Hz}$, $J = 5\text{ Hz}$, 1H), 6.05 (d, $J = 12\text{ Hz}$, 1H), 4.55 (br, 1H), 3.57 (s, 3H), 2.90-2.75 (m, 2H), 2.63-2.40 (m, 2H), 2.12-1.80 (m, 2H).

$^{13}\text{C NMR}$: 200.0, 155.9, 146.1, 132.0, 52.2, 50.9, 47.8, 30.5, 28.8, 27.4.

IR: 1695, 1665 cm^{-1} .

MS: (EI) 197 (30), 138 (23), 128 (25), 115 (76), 108 (100), 90 (64), 82 (52), 81 (35).

Anal. Calcd for $\text{C}_{10}\text{H}_{15}\text{NO}_3$: C, 60.89; H, 7.65; N, 7.10. Found: C, 60.65; H, 7.74; N, 7.01.

6-(*N*-Methoxycarbonyl-*N*-methyl)amino-2,3-epoxycycloheptan-1-one

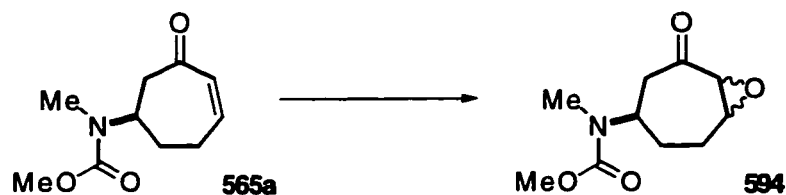

The methoxycarbonyl derivative **594** was prepared in the same way as the Cbz derivative **598**. The product was a mixture of two isomers and was obtained as a colorless oil (yield 85%).

major isomer $R_f = 0.44$, minor isomer $R_f = 0.32$ (1:1 hexane/AcOEt)

^{13}C NMR: (major isomer) 207.0 156.2, 59.0, 55.6, 52.1, 49.6, 43.9, 29.2, 28.2, 25.1.

IR: 1699 cm^{-1} .

^1H -NMR: (major isomer) 4.65-4.50 (m, 1H), 4.00-3.60 (m, 1H), 3.70 (s, 3H), 3.45-3.45 (m, 2H), 3.18 (t, $J = 12$ Hz, 1H), 2.76 (s, 3H), 2.50-2.48 (m, 1H), 2.30-1.90 (m, 2H), 1.75-1.55 (m, 1H).

MS: (EI) 213 (24), 142 (100), 115 (57), 96 (67), 95 (34), 81 (29), 59 (43), 56 (49), 55 (34).

HRMS: 213.101 (M^+), calcd for $\text{C}_{10}\text{H}_{15}\text{NO}_4$ 213.100.

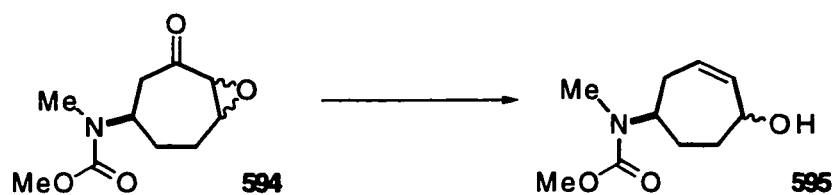
5-(*N*-Methoxycarbonyl-*N*-methyl)amino-2-cyclohepten-1-ol

This compound was prepared in the same way as the Cbz derivative **599** (yield 45%).

¹H-NMR: (major isomer) 5.85-5.10 (m, 2H), 4.50-4.10 (m, 1H), 3.63 (s, 3H), 2.75 (s, 3H), 2.52-2.45 (m, 2H), 2.35 (d, $J = 10$ Hz, 1H), 2.20-2.08 (m, 1H), 2.07-1.70 (m, 4H).

IR: 3416, 1697, 1679 cm^{-1} .

MS: (EI) 199 (3), 181 (58), 128 (47), 118 (28), 102 (31), 92 (38), 90 (100), 42 (39).

HRMS: 199.121 (M^+), calcd for $\text{C}_{10}\text{H}_{17}\text{NO}$ 199.121.

5-(*N*-Methoxycarbonyl-*N*-methyl)amino-2-cyclohepten-1-one

This compound was prepared in the same way as the Cbz derivative **600** (yield 85%).

¹H-NMR: 6.57 (ddd, $J = 12$ Hz, $J = 6.5$ Hz, $J = 5$ Hz, 1H), 6.07 (d, $J = 12$ Hz, 1H), 4.50 (br, 1H), 3.77 (s, 3H), 2.89 (s, 3H), 2.80-2.53 (m, 4H), 2.09-1.85 (m, 2H).

IR: 1668, 1696 cm^{-1} .

MS: (EI) 197 (88), 128 (41), 108 (100), 90 (45), 80 (31), 79 (28), 59 (26), 42 (63).

HRMS: 197.105(M^+), calcd for $\text{C}_{10}\text{H}_{15}\text{NO}$ 197.105.

3-(N-Benzyloxycarbonyl-N-methyl)amino-6-methoxycycloheptan-1-one

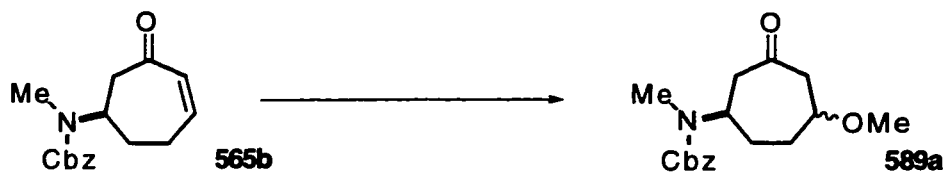

A catalytic amount of NaH (0.01 g of 80% suspension in oil) was added to dry MeOH (3 mL) and stirred until evolution of hydrogen ceased. A solution of the enone **565b** (0.273 g, 1 mmol) in MeOH (1 mL) was then added, and the mixture was stirred at rt for 15 min (TLC showed no starting material). The reaction mixture was then diluted with water (20 mL) and extracted with ether (3 x 20 mL). The combined extracts were dried (MgSO₄) and the solvent was removed under vacuum. Purification of the residue on DFC (10-50% AcOEt/hexane) gave the product (0.280 g, 92%) as a colorless oil.

¹H-NMR: (major isomer) 7.45-7.25 (m, 5H), 5.15 (s, 2H), 4.65-4.25 (m, 1H), 3.68 (s, 1H), 3.32 (s, 3H), 2.80 (s, 3H), 2.49-2.48 (m, 4H), 2.33-1.55 (m, 4H).

IR: 1696 (C=O) cm⁻¹.

MS: (EI) 305 (5), 214 (5), 170 (14), 169 (8), 160 (11), 149 (17), 92 (9), 91 (100).

HRMS: 305.1626 (M⁺), calcd for C₁₇H₂₃NO₄ 305.1627.

3-(N-Benzyloxycarbonyl-N-methyl)amino-6-benzyloxycycloheptan-1-one

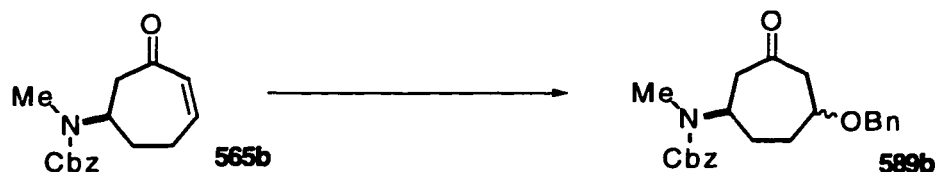

A catalytic amount of NaH (0.01 g of 80% suspension in oil) was added to dry benzyl alcohol (1 mL) and stirred until dissolved. The enone **565b** (0.273 g, 1 mmol) was added and the mixture was stirred at rt for 30 min (TLC showed no starting material). The reaction mixture was diluted with water (15 mL) and extracted with ether (3 x 20 mL). The combined extracts were dried (MgSO₄) and the solvent was removed under vacuum. Purification of the residue (containing BnOH) on DFC (5-35% AcOEt/hexane) gave the product (0.267 g, 70%) as a colorless oil.

¹H-NMR: (major isomer) 7.45-7.25 (m, 10H), 5.15 (s, 2H), 4.68-4.45 (m, 2H), 2.80 (s, 3H), 3.05-2.48 (m, 4H), 2.87-1.58 (m, 4H).

IR: 1697 (C=O) cm⁻¹.

MS: (EI) 381 (2), 290 (5), 275 (4), 246 (11), 184 (7), 160 (7), 149 (15), 91 (100).

HRMS: 381.195 (M⁺), calcd for C₂₃H₂₇NO₄ 381.194.

3-(N-Benzyloxycarbonyl-N-methyl)amino-6-benzyloxycycloheptan-1-ol

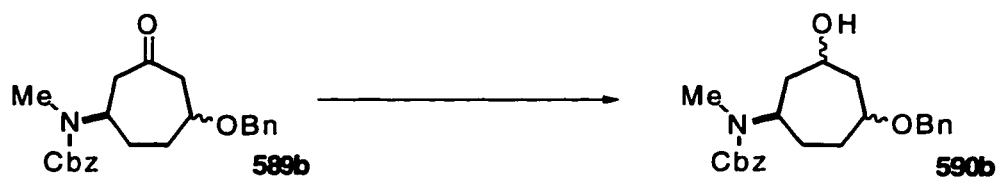

Sodium borohydride (0.015 g, 0.40 mmol) was added to a solution of **589b** (0.127 g, 0.33 mmol) in ethanol (5 mL) at 0 °C. The mixture was stirred for 1h, diluted with water (25 mL) and extracted with CHCl₃ (3 x 10 mL). The combined extracts were dried (MgSO₄) and the solvent was removed under vacuum. Purification of the residue on DFC (10-50% AcOEt/hexane) gave product (0.283 g, 85%) as a colorless oil.

¹H-NMR: (major isomer) 7.50-7.25 (m, 10H), 5.18 (s, 2H), 4.65-4.45 (m, 2H), 4.50-4.15 (m, 2H), 3.82 (s, 1H), 2.88 (s, 3H), 2.25-1.55 (m, 9H).

IR: 3458 (OH), 1693 (C=O) cm⁻¹.

MS: (EI) 383 (1.2), 292 (2), 249 (4), 248 (25), 166 (6), 160 (5), 92 (9), 91 (100).

HRMS: 383.2082 (M⁺), calcd for C₂₃H₂₉NO₄ 383.2096.

3.8. Syntheses of derivatives of nortropinone and other reactions

***N*-(Benzyloxycarbonyl)nortropinone (ref 158)**

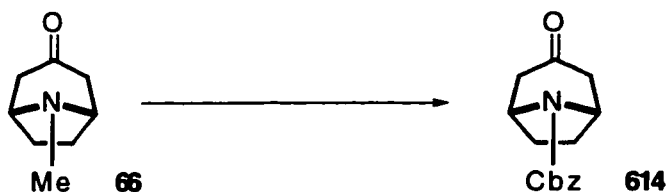

This product was prepared according to a modified literature procedure.¹⁵⁸

Benzyl chloroformate (9 mL) was added dropwise over 8h to a stirred mixture of tropinone (2.78 g, 20 mmol), K_2CO_3 (0.2 g), and benzene (20 mL) at 70 °C. The mixture was stirred for 12 h at 70 °C and was then cooled, treated with aqueous KOH, and extracted with Et_2O . The combined extracts were dried ($MgSO_4$) and the solvents were removed under vacuum. High vacuum distillation in a Kugelrohr apparatus (at 225 °C/0.5 mmHg) of the residue gave the crude product (2.75 g, 53%). Analytical sample was purified by FCC (10-20 % AcOEt in hexane).

1H -NMR: 7.40-7.30 (m, 5H), 5.20 (s, 2H), 4.60 (s, 2H), 2.80-2.50 (m, 2H), 2.40-2.30 (m, 2H), 2.20-2.05 (m, 2H), 2.75-2.65 (m, 2H).

***N*-(2,2,2-Trichloroethyloxycarbonyl)nortropinone** (ref 159)

A mixture of tropinone (9.95 g, 71.6 mmol), benzene (35 mL), K_2CO_3 (0.5 g), and 2,2,2-trichloroethyl chloroformate (16.7 g, 78.8 mmol) was refluxed for 18 h. The reaction mixture was then cooled to rt, treated with aqueous KOH, and extracted with Et_2O . The combined extracts were dried ($MgSO_4$) and the solvents were removed under vacuum. Purification of the crude product (oil) by DFC (5-15% AcOEt in hexane) gave a white solid (19.51 g, 91%)

mp 78-80 °C, lit.¹⁵⁹ mp 79-80 °C

1H -NMR: 5.30 (s, 2H), 4.85-4.55 (m, 2H), 2.88-2.62 (m, 2H), 2.50-2.35 (m, 2H), 2.30-2.05 (m, 2H), 1.90-1.60 (m, 2H).

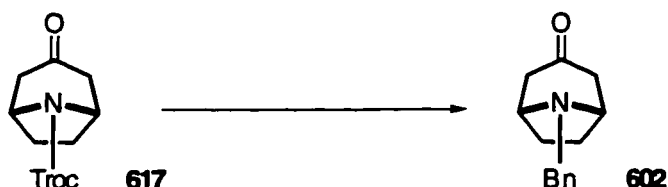
***N*-Benzylnortropinone** (ref 50)

A mixture of *N*-(2,2,2-trichloroethoxycarbonyl)nortropinone (12 g, 40 mmol), methanol (160 mL), and zinc powder (20 g) was heated under reflux condenser until an exothermic reaction started. After the boiling ceased the mixture was refluxed for 30 minutes. The mixture was then cooled to rt and filtered through Celite. The filtrate was diluted with methanol (300 mL), treated with benzaldehyde (12 mL, 118 mmol) and NaBH₃CN (3.78 g, 60 mmol), and left at rt for 12 h (the pH of the mixture was 6-7). The solvent was then removed under vacuum, the residue was diluted with water (150 mL), and basified with NH₃aq (14 mL) and extracted with chloroform. The chloroform extracts were washed with 1% H₂SO₄ (220 mL). The acidic extracts were basified (9.2 g KOH in water) and extracted with chloroform. The combined chloroform extracts were dried and the solvent was removed under vacuum. High vacuum distillation of the residue (bp 145-147 °C/1 mmHg) gave the pure product (4.69 g, 55%).

¹H-NMR: 7.50-7.18 (m, 5H), 3.78 (s, 2H), 3.50 (s, 2H), 2.70 (dd, *J* = 16.5 Hz, *J* = 5 Hz, 2H), 2.20 (d, *J* = 16.5 Hz, 2H), 2.20-2.05 (m, 2H), 1.70-1.55 (m, 2H).

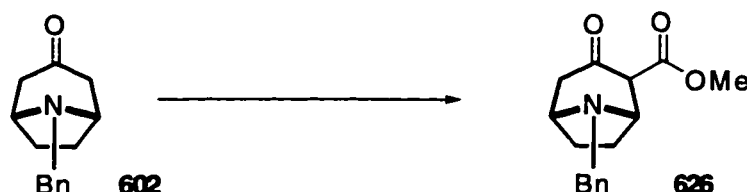
***N*-Benzyl-2-methoxycarbonylnortropinone**

Methyl cyanoformate (0.12 mL, 0.129 g, 1.5 mmol) was added to a solution of lithium enolate prepared from **602** (1 mmol, procedure analogous to *method A*) and the mixture was stirred at $-78\text{ }^{\circ}\text{C}$ for 30 min followed by quenching with 40% solution of K_2CO_3 . After bringing to rt the reaction mixture was diluted with water and extracted with chloroform (4 x 10 mL). The combined extracts were dried (MgSO_4), the solvent was removed under vacuum and the residue was subjected to DFC (50% AcOEt in hexane). The product was obtained as a colorless oil (0.221 g, 81%).

$^1\text{H-NMR}$: (major tautomer) 7.50-7.20 (m, 5H), 3.85-3.78 (m, 1H), 3.78 (s, 3H), 3.72-3.62 (m, 2H) 3.55-3.40 (m, 1H), 2.90-2.75 (m, 1H), 2.35-2.05 (m, 4H), 1.95-1.55 (m, 2H).

IR: 1740, 1654 cm^{-1} .

MS: (EI) 273 (44), 245 (30), 241 (13), 212 (20), 158 (29), 157 (15), 91 (100), 65 (12).

Anal. Calcd for $\text{C}_{16}\text{H}_{19}\text{NO}_3$: C, 70.31; H, 7.01; N, 5.12. Found: C, 70.11; H, 7.02; N, 5.15.

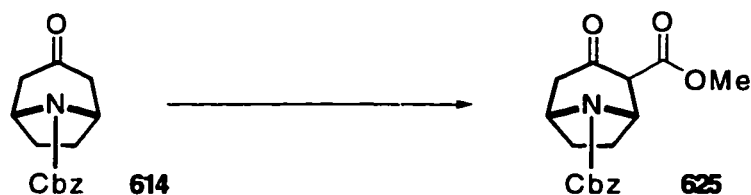
N-Benzyloxycarbonyl-2-methoxycarbonylnortropinone

Methyl cyanoformate (0.12 mL, 0.129 g, 1.5 mmol) was added to a solution of the lithium enolate prepared from **614** (1 mmol, procedure analogous to *method A*) and the mixture was stirred at $-78\text{ }^{\circ}\text{C}$ for 30 min followed by quenching with solution of AgNO_3 (0.17 g, 1 mmol) in THF (1 mL), water (0.25 mL) and AcOH (0.25 mL). After bringing to rt the reaction mixture was diluted with water and extracted with chloroform (4 x 10 mL). The combined extracts were dried (MgSO_4), the solvent was removed under vacuum and the residue was subjected to DFC (50% AcOEt in hexane, $R_f = 0.69$). The product was obtained as a colorless oil (0.110 g, 35%).

$^1\text{H-NMR}$: (major tautomer) 7.50-7.25 (m, 5H), 5.30-5.10 (m, 2H), 4.95 (s, 1H), 4.8-4.45 (m, 1H) 3.70-2.80 (m, 1H), 2.45-1.60 (m, 5H).

IR: (C=O) 1704, 1656 cm^{-1} .

MS: (EI) 317 (7), 288 (8), 244 (9), 182 (6), 158 (8), 154 (10), 149 (14), 91 (100).

HRMS: 317.126 (M^+), calcd for $\text{C}_{17}\text{H}_{19}\text{NO}_5$ 317.126.

(±)-(1*S*,2*R*,1'*S*)-2-(1'-Hydroxybenzyl)-8-benzyl-8-azabicyclo[3.2.1]octane-3-one

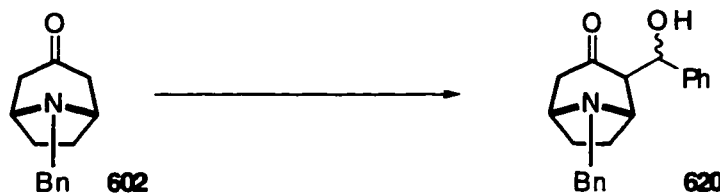

Benzaldehyde (0.13 mL, 0.136 g, 1.28 mmol) was added to the solution of the racemic lithium enolate prepared from **602** (1 mmol, procedure analogous to *method A*) and the mixture was stirred at -78 °C for 15 min followed by quenching with saturated aq NH_4Cl (4 mL). The reaction mixture was warmed up to rt, and extracted with ether (4 x 10 mL). The combined extracts were dried (MgSO_4), the solvent was removed under vacuum and the residue was subjected to DFC (10-50% AcOEt in hexane). After removal of the solvent and benzaldehyde (high vacuum overnight), a white semisolid product was obtained (0.273 g, 85%).

$R_f = 0.53$ (1:1 hex AcOEt)

$^1\text{H-NMR}$: (major isomer) 7.55-7.20 (m, 10H), 5.34 (d, $J = 3$ Hz, 1H), 3.78-3.64 (m, 2H), 3.70-3.50 (m, 2H), 2.85 (dd, $J = 4$ Hz, $J = 15.5$ Hz, 1H), 2.55-2.12 (m, 4H), 1.80-1.60 (m, 1H).

IR: 3442 (OH), 1711 (C=O) cm^{-1} .

MS: (EI) 321 (6), 215 (20), 159 (23), 158 (44), 157 (27), 105 (20), 91 (100), 77 (22).

HRMS: 321.1722 (M^+), calcd for $\text{C}_{21}\text{H}_{23}\text{NO}_2$ 321.1729.

(±)-(1*S*,2*R*,1'*S*)-2-(1'-Hydroxybenzyl)-8-benzyloxycarbonyl-8-azabicyclo[3.2.1.]octane-3-one

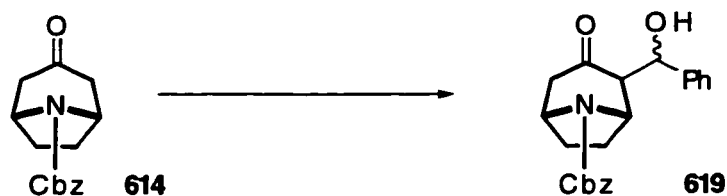

Benzaldehyde (0.13 mL, 0.136 g, 1.28 mmol) was added to the solution of the racemic lithium enolate prepared from **614** (1 mmol, procedure analogous to *method A*) and the mixture was stirred at $-78\text{ }^{\circ}\text{C}$ for 15 min followed by quenching with saturated aq NH_4Cl (4 mL). The reaction mixture was warmed up to rt, and extracted with ether (4 x 10 mL). The combined extracts were dried (MgSO_4), the solvent was removed under vacuum and the residue was subjected to DFC (10-50% AcOEt in hexane). After removal of the solvent and benzaldehyde (high vacuum overnight), a white semisolid product was obtained (0.186 g, 51%).

$^1\text{H-NMR}$: 7.70-7.00 (m, 10H), 5.40-5.10 (m, 2H), 4.95-4.70 (m, 2H), 4.30 (s, 1H), 2.91 (dd, $J = 4\text{ Hz}$, $J = 15.5$, 1H), 2.62 (d, $J = 10\text{ Hz}$, 1H), 2.43 (d, $J = 15.5$, 1H), 2.08-1.88 (m, 2H), 1.72-1.50 (m, 2H).

IR: 3437 (OH), 1699 (C=O) cm^{-1} .

MS: (EI) 124 (11), 107 (4), 106 (24), 105 (23), 92 (9), 91 (100), 78 (4), 77 (24).

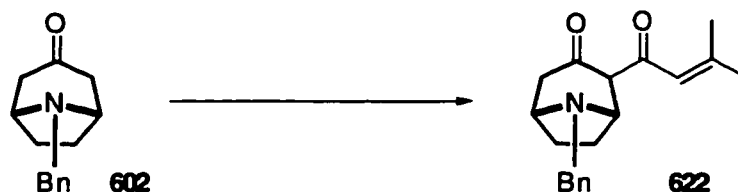
2-Senecioidyl-8-(benzyl)nortropinone

Senecioidyl cyanide (0.10 mL, 0.14 g, 1.3 mmol) was added to a preformed solution of lithium enolate of **602** (1 mmol, *method A*) and the mixture was stirred at $-78\text{ }^{\circ}\text{C}$ for 60 minutes followed by quenching with 40% K_2CO_3 (4 mL). After warming to rt the reaction mixture was extracted with ether (3 x 10 mL). The combined extracts were dried (MgSO_4) and the solvent was removed under vacuum to give the crude product (0.337 g) which after DFC (10-50% AcOEt in hexane, 50% for TLC, $R_f = 0.62$.) gave a yellowish oil (0.259 g, 87%).

$^1\text{H-NMR}$: (major tautomer) 7.42-7.20 (m, 5H), 5.35 (s, 1H), 3.90 (d, $J = 4.5\text{ Hz}$, 1H), 3.75 (d, $J = 13\text{ Hz}$, 1H), 3.68 (d, $J = 19\text{ Hz}$, 1H), 3.48 (s, 1H), 2.88 (dd, $J = 19\text{ Hz}$, $J = 5\text{ Hz}$, 1H), 2.35-2.18 (m, 2H), 2.20 (s, 3H), 2.10 (d, $J = 19\text{ Hz}$, 1H), 1.95 (s, 3H), 1.85-1.60 (m, 2H).

IR: 1635 (C=O) cm^{-1} .

MS: (EI) 297 (49), 269 (28), 268 (68), 158 (14), 148 (14), 91 (100), 83 (17), , 55 (12).

HRMS: 297.173 (M^+), calcd for $\text{C}_{19}\text{H}_{23}\text{NO}_2$ 297.173.

2-Senecioid-8-(benzyloxycarbonyl)nortropinone

Senecioid cyanide (0.10 mL, 0.14 g, 1.3 mmol) was added to a preformed solution of lithium enolate of **614** (1 mmol, *method A*) and the mixture was stirred at $-78\text{ }^{\circ}\text{C}$ for 60 minutes followed by quenching with 40% K_2CO_3 (4 mL). After warming to rt the reaction mixture was extracted with ether (3 x 10 mL). The combined extracts were dried (MgSO_4) and the solvent was removed under vacuum to give the crude product (0.337 g) which after DFC (10-50% AcOEt in hexane, 50% for TLC) gave a yellowish oil (0.129 g, 38%).

$^1\text{H-NMR}$: (major tautomer) 7.45-7.20 (m, 5H), 6.10-5.90 (m, 1H), 5.15 (s, 2H), 5.15-4.90 (m, 1H) 4.50 (s, 1H), 3.15-2.85 (m, 1H), 2.30-2.05 (m, 3H), 2.18 (s, 3H), 1.95 (s, 3H), 1.90-1.65 (m, 2H).

IR: 1703 (C=O) cm^{-1} .

MS: (EI) 341 (9), 326 (16), 268 (8), 178 (22), 148 (8), 122 (8), 91 (100), 83 (21).

HRMS: 341.163 (M^+), calcd for $\text{C}_{20}\text{H}_{23}\text{NO}_4$ 341.163.

**(±)-11,11-Dimethyl-10,11-dihydropyrano-8-benzyl-8-azabicyclo-
[3.2.1]-3-octanone**



This compound was prepared *via* a cyclization under conditions used previously for the cyclization of *N*-methyl analog **491b**. Yield 93%.

$R_f = 0.45$ (1:1 hexane/AcOEt)

$^1\text{H-NMR}$: 7.42-7.22 (m, 5H), 4.10 (d, $J = 5$ Hz, 1H), 3.69-3.57 (m, 2H), 3.42 (t, $J = 5$ Hz, 1H), 2.70 (dd, $J = 4$ Hz, $J = 18.5$ Hz, 1H), 2.50 (d, $J = 16.5$ Hz, 1H), 2.58 (d, $J = 16.5$ Hz, 1H), 2.27-2.07 (m, 2H), 1.85 (d, 18.5 Hz, 1H), 1.80-1.68 (m, 1H), 1.69-1.48 (m, 1H), 1.48 (s, 3H), 1.46 (s, 3H).

IR: 1609 (C=C), 1659 (C=O) cm^{-1} .

MS: (EI) 298 (11), 297 (49), 269 (33), 268 (100), 241 (7), 212 (9), 122 (7), 91 (59).

HRMS: 297.174 (M^+), calcd for $\text{C}_{19}\text{H}_{23}\text{NO}_2$ 297.173.

(±)-11,11-Dimethyl-10,11-dihydropyrano-8-benzyloxycarbonyl-8-azabicyclo-[3.2.1]-3-octanone

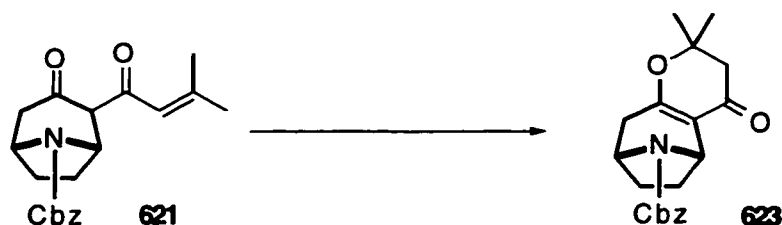

This compound was prepared *via* a cyclization under conditions used previously for the cyclization of *N*-methyl analog **491b**. Yield 95%.

¹H-NMR: 7.45-7.25 (m, 5H), 5.15 (s, 2H), 4.50 (s, 2H), 3.00-2.75 (m, 1H), 2.58-2.35 (m, 2H), 2.30-1.90 (m, 3H), 1.87-1.77 (m, 1H), 1.68-1.55 (m, 1H), 1.41 (s, 3H), 1.31 (s, 3H).

IR: 1605 (C=C), 1660 (C=O), 1703 (C=O) cm⁻¹.

MS: (EI) 341 (10), 312 (9), 268 (25), 222 (8), 178 (38), 122 (10), 91 (100), 57 (16).

HRMS: 341.163 (M⁺), calcd for C₂₀H₂₃NO₄ 341.163.

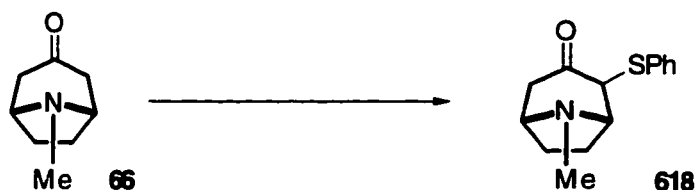
2-(Phenylsulfanyl)tropinone

Phenyl disulfide (0.262 g, 1.20 mmol) was added to a solution of tropinone lithium enolate (1 mmol, *method A*) at -78 °C and the mixture was slowly warmed up to rt and stirred for 5h followed by quenching with 10% KOH (8 mL). The mixture was extracted with ether (3 x 10 mL). The combined extracts were dried (MgSO_4) and the solvent was removed under vacuum to give the crude product, which after DFC (10-50% AcOEt in hexane followed by 3% MeOH in CH_2Cl_2) gave a yellowish oil (0.185 g, 75%).

$^1\text{H-NMR}$: (major isomer) 7.35-7.20 (m, 5H), 4.25 (d, $J = 5$ Hz, 1H), 3.45-3.20 (m, 2H) 2.73 (dd, $J = 16$ Hz, $J = 5$ Hz, 1H), 2.38 (s, 3H), 2.25 (dd, $J = 16$ Hz, $J = 3$ Hz, 1H), 2.18-1.80 (m, 3H), 1.60-1.40 (m, 1H).

IR: 1710 cm^{-1} .

MS: (EI) 247 (23), 138 (6), 97 (11), 96 (13), 83 (7), 82 (100), 81 (4).

HRMS: 247.104 (M^+), calcd for $\text{C}_{14}\text{H}_{17}\text{NOS}$ 247.103.

REFERENCES

1. Fleming, I. *Selected Organic Syntheses*; A Wiley-Interscience: Toronto, 1973.
2. *Selectivity - a Goal for Synthetic Efficiency*; Bartmann, W.; Trost, B. M. Eds.; Verlag Chemie: Deerfield Beach Florida, 1984.
3. (a) Seebach, D.; Hungerbühler, E. In *Modern Synthetic Methods 1980*; Scheffold, R. Ed.; Salle & Sauerländer Verlag: Frankfurt and Aarau, 1980.
(b) Seebach, D.; Imwinkelried, R. Weber, T. In *Modern Synthetic Methods 1986*; Scheffold, R. Ed.; Springer-Verlag: New York, 1986.
4. (a) *Asymmetric Synthesis*, Morrison, J. D. Ed.; Academic Press Inc: Toronto, 1983-1986; Vol. 2-5.
(b) Mekelburger, H. B.; Wilcox, C. S. In *Comprehensive Organic Synthesis*; Heathcock, C. H. Ed.; Pergamon Press: New York, 1991; Vol 2, p 99.
5. Recent review: Majewski, M. 'Carbanion chemistry with chiral bases: Enantiodifferentiating proton transfer reactions with chiral lithium amides and chiral amines' will appear in *Comprehensive Carbanion Chemistry*; Snieckus, V. Ed.; JAI Press, Vol. 3.
6. Simpkins, N. S. *J. Chem. Soc. Chem. Commun.* **1986**, 88.
7. Shirai, R.; Tanaka, M.; Koga, K. *J. Am. Chem. Soc.* **1986**, *108*, 543.
8. Cox, P. J.; Simpkins, N. S. *Tetrahedron: Asymmetry* **1991**, *2*, 1.
9. Momose, T.; Toyooka, N.; Hirai, Y. *Chem. Lett.* **1990**, 1319.

10. Momose, T.; Toyooka, N.; Seki, S.; Hirai, Y. *Chem. Pharm. Bull.* **1990**, *38*, 2072.
11. Zheng, G-Z. M.Sc. thesis, University of Saskatchewan 1991.
12. Majewski, M.; Zheng, G.-Z. *Synlett* **1991**, 173.
13. Majewski, M.; Zheng, G.-Z. *Can. J. Chem.* **1992**, *70*, 2618.
14. Galiano-Roth, A. S.; Collum, D. B. *J. Am. Chem. Soc.* **1989**, *111*, 6772
15. Miller, D. J.; Saunders, W. H. Jr. *J. Org. Chem.* **1982**, *47*, 5039.
16. Al-Aseer, M.; Beak, P.; Hay, D.; Kempf, D. J.; Mills, S.; Smith, S. G. *J. Am. Chem. Soc.* **1983**, *105*, 2080.
17. Meyers, A. I.; Rieker, W. F.; Fuentes, L. M. *J. Am. Chem. Soc.* **1983**, *105*, 2082.
18. (a) Sato, D.; Kawasaki, H.; Shimada, I.; Arata, Y.; Okmura, K.; Date, T.; Koga, K. *J. Am. Chem. Soc.* **1992**, *114*, 761.
(b) Koga, K. *Pure Appl. Chem.* **1994**, *66*, 1487.
19. Mander, L. N.; Sethi, S. P. *Tetrahedron Lett.* **1983**, *24*, 5425.
20. Galiano-Roth, A. S.; Kim, Y.-J.; Gilchrist, J. H.; Harrison, A. T.; Fuller, D. J.; Collum, D. B. *J. Am. Chem. Soc.* **1991**, *113*, 5053.
21. Coggins, P.; Gaur, S.; Simpkins, N. S. *Tetrahedron Lett.* **1995**, *36*, 1545.
22. Laube, T.; Dunitz, J. D.; Seebach, D. *Helv. Chim. Acta* **1985**, *68*, 1373.
23. Collum, D. B. *Acc. Chem. Res.* **1993**, *26*, 227.
24. Bunn, B. J.; Simpkins, N. S. *J. Org. Chem.* **1993**, *58*, 533.
25. Bunn, B. J.; Simpkins, N. S.; Spavold, Z.; Crimmin, J. *J. Chem. Soc., Perkin Trans. 1* **1993**, 3113.
26. Aoki, K.; Nakajima, M.; Tomioka, K.; Koga, K. *Chem. Pharm. Bull.* **1993**, *45*, 994.
27. Majewski, M.; Gleave, D. M. *J. Org. Chem.* **1992**, *57*, 3599.

28. Majewski, M.; MacKinnon, J. *Can. J. Chem.* **1994**, *72*, 1699.
29. (a) Williard, P. G.; Hintze, M. J. *J. Am. Chem. Soc.* **1987**, *109*, 5539.
(b) Williard, P. G.; Liu, Q.-Y. *J. Am. Chem. Soc.* **1993**, *115*, 3380.
(c) Williard, P. G.; Hintze, M. J. *J. Am. Chem. Soc.* **1990**, *112*, 8602.
(d) Williard, P. G.; Salvino, J. M. *J. Org. Chem.* **1993**, *58*, 1.
(e) Williard, P. G.; Liu, Q.-Y. *J. Am. Chem. Soc.* **1992**, *114*, 348.
30. Vedejs, E.; Lee, N. *J. Am. Chem. Soc.* **1991**, *113*, 5483.
31. Bunn, B. J.; Cox, P. J.; Simpkins, N. S. *Tetrahedron Lett.* **1993**, *49*, 207.
32. Seebach, D.; Amstutz, R.; Dunitz, J. D. *Helv. Chim. Acta* **1981**, *64*, 2622.
33. (a) Lounasmaa, M.; Tamminen, T. *The Alkaloids*, 1993, Vol. 44, Chapter 1.
(b) Lounasmaa, M. *The Alkaloids*, 1988, Vol. 33, Chapter 1.
34. Clarke, R. L. In *The Alkaloids*; Manske, R. H. F., Ed.; Academic Press: New York, 1977, Vol. 16, Chapter 2.
35. (a) Fodor, G. In *The Alkaloids*; Manske, R. H. F., Ed.; Academic Press: New York, 1971, Vol. 13, Chapter 8.
(b) Fodor, G. In *The Alkaloids*; Manske, R. H. F., Ed.; Academic Press: New York, 1967, Vol. 9, Chapter 7.
(c) Fodor, G. In *The Alkaloids*; Manske, R. H. F., Ed.; Academic Press: New York, 1960, Vol. 6, Chapter 5.
36. Holmes, H. L. In *The Alkaloids*; Manske, R. H. F., Ed.; Academic Press: New York, 1950, Vol. 1, Chapter 6.
37. (a) Corey, E. J.; Sneed, R. A. *J. Am. Chem. Soc.* **1956**, *78*, 6269.
(b) Deslongchamps, P. *Stereoelectronic Effects in Organic Chemistry*; Pergamon Press: Toronto, 1983.
38. Willstätter, R. *Chem. Ber.* **1901**, *34*, 129, 3163.

39. Willstätter, R. *Chem. Ber.* **1896**, *29*, 936.
40. Bottini, A. T.; Gal, J. *J. Org. Chem.* **1971**, *36*, 1718.
41. Sato, T.; Sato, K.; Mukai, T. *Bull. Chem. Soc.* **1971**, *44*, 1708.
42. Kashman, Y.; Cherkez, S. *Tetrahedron* **1972**, *28*, 155.
43. Kashman, Y.; Cherkez, S. *Synthesis* **1974**, 885.
44. Wiger, G. R.; Rettig, M. F. *J. Am. Chem. Soc.* **1976**, *98*, 4168.
45. Garbisch, E. W. Jr. *J. Org. Chem.* **1965**, *30*, 2109.
46. Robinson, R. *J. Chem. Soc.* **1917**, 762.
47. Schöpf, C.; Lehmann, G.; Arnold, W. *Angew. Chem.* **1937**, *50*, 783.
48. Schöpf, C. *Angew. Chem.* **1937**, *50*, 779, 797.
49. Schöpf, C.; Lehmann, G. *Liebigs Ann. Chem.* **1935**, *518*, 5.
50. Keagle, L. C.; Hartung, W. H. *J. Am. Chem. Soc.* **1946**, *68*, 1608.
51. Willstätter, R.; Pfannenstiel, M. *Liebigs Ann. Chem.* **1921**, *422*, 1.
52. Parker, W.; Raphael, R. A.; Wilkinson, D. I. *J. Chem. Soc.* **1959**, 2433.
53. Yamaguchi, A.; Numata, A.; Hokimoto, K. *Yakugaku Zasshi* **1974**, *94*, 1115; *Chem. Abst.* **1975**, *82*, 73255q.
54. Daum, S. J.; Martini, C. M.; Kullnig, R. K.; Clarke, R. L. *J. Med. Chem.* **1975**, *18*, 496.
55. Cignarella, G.; Gallo, G. G.; Testa, E. *J. Am. Chem. Soc.* **1961**, *83*, 4999.
56. Lansbury, P. T.; Spagnuolo, C. J.; Zhi, B.; Grimm, E. L. *Tetrahedron Lett.* **1990**, *31*, 3965.
57. Zirkle, C. L.; Geissman, T. A.; Bloom, M.; Craig, P. N.; Gems, F. R.; Indik, Z.; Pavloff, A. M. *J. Org. Chem.* **1962**, *27*, 1269.
58. Zirkle, C. L.; Anderson, E. F.; Gems, F. R.; Indik, Z.; Pavloff, A. M. *J. Org. Chem.* **1962**, *27*, 1279.

59. Tufariello, J. J.; Trybulski, E. J. *J. Chem. Soc., Chem. Commun.* **1973**, 720.
60. Backväll, J.-E.; Renko, Z. D.; Byström, S. E. *Tetrahedron Lett.* **1987**, *28*, 4199.
61. Schink, H. E.; Pettersson, H.; Backväll, J.-E. *J. Org. Chem.* **1991**, *56*, 2769.
62. Iida, H.; Watanabe, Y.; Kibayashi, C. *Tetrahedron Lett.* **1984**, *25*, 5091.
63. Iida, H.; Watanabe, Y.; Kibayashi, C. *J. Org. Chem.* **1985**, *50*, 1818.
64. Justice, D. E.; Malpass, J. R. *Tetrahedron Lett.* **1995**, *36*, 4689.
65. Bathgate, A.; Malpass, J. R. *Tetrahedron Lett.* **1987**, *28*, 5937.
66. Justice, D. E.; Malpass, J. R. *Tetrahedron Lett.* **1995**, *36*, 4685.
67. Naylor (née Bathgate), A.; Howarth, N.; Malpass, J. R. *Tetrahedron* **1993**, *49*, 451.
68. Nedenskov, P.; Clauson-Kaas, N. *Acta Chem. Scand.* **1954**, *8*, 1295.
69. Stoll, A.; Lindenmann, A.; Jucker, E. *Helv. Chim. Acta* **1953**, *36*, 1500.
70. Stoll, A.; Becker, B.; Jucker, E. *Helv. Chim. Acta* **1952**, *35*, 1263.
71. Fodor, G.; Toth, J.; Koczor, I.; Vincze, I. *Chem. Ind.* **1955**, 1260.
72. Xiang, Z.; Zhou, J. E.; Chen, Z. N.; Wang, L. P.; Wang, H. N.; Yao, T. R.; Xie, J. X.; Xu, G. Y.; Yi, D. N. *Acta Pharm. Sinica* **1989**, *24*, 105; *Chem. Abstr.* **1990**, *112*, 198846c.
73. Jung, M. E.; Longmei, Z.; Tangsheng, P.; Huiyan, Z.; Yan, L.; Jingyu, S. *J. Org. Chem.* **1992**, *57*, 3528.
74. Katritzky, A. R.; Takeuchi, Y. *J. Chem. Soc. (C)* **1971**, 874.
75. Banerji, J.; Dennis, N.; Frank, J.; Katritzky, A. R.; Matsuo, T. *J. Chem. Soc.; Perkin Trans. 1* **1976**, 2334.
76. Tufariello, J. J.; Mullen, G. B. *J. Am. Chem. Soc.* **1978**, *100*, 3638.
77. Tufariello, J. J. *Acc. Chem. Res.* **1979**, *12*, 396.

78. Tufariello, J. J.; Tegeler, J. J.; Wong, S. Ch.; Ali, Sk. A. *Tetrahedron Lett.* **1978**, 1733.
79. Tufariello, J. J.; Mullen, G. B.; Tegeler, J. J.; Trybulski, E. J.; Wong, S. Ch.; Ali, Sk. A. *J. Am. Chem. Soc.* **1979**, *101*, 2435.
80. Davies, H. M. L.; Saikali, E.; Young, W. B. *J. Org. Chem.* **1991**, *56*, 5696.
81. Davies, H. M. L.; Huby, N. J. S. *Tetrahedron Lett.* **1992**, *33*, 6935.
82. Davies, H. M. L.; Young, W. B.; Smith, H. D. *Tetrahedron Lett.* **1989**, *30*, 4563.
83. Furuya, S.; Okamoto, T. *Heterocycles* **1988**, *27*, 2609.
84. Nagata, W.; Wakabayashi, T.; Haga, N. *Synth. Commun.* **1972**, *2*, 11.
85. Turro, N. J.; Edelson, S. E. *J. Am. Chem. Soc.* **1968**, *90*, 4499.
86. Bick, I. R. C.; Bremner, J. B.; Gillard, J. W. *Tetrahedron Lett.* **1973**, 5099.
87. Bick, I. R. C.; Gillard, J. W.; Leow, H.-M. *Aust. J. Chem.* **1979**, *32*, 1827.
88. Lounasmaa, M.; Langenskiöld, T.; Holmberg, C. *Tetrahedron Lett.* **1981**, *22*, 5179.
89. (a) Lounasmaa, M.; Holmberg, C.; Langenskiöld, T. *J. Nat. Prod.* **1983**, *46*, 429.
(b) Lounasmaa, M.; Pusset, J.; Sevenet, T. *Phytochemistry* **1980**, *19*, 953.
90. Lounasmaa, M.; Holmberg, C.; Langenskiöld, T. *Planta Medica* **1983**, *48*, 56.
91. (a) Lounasmaa, M.; Johansson, C.-J. *Tetrahedron Lett.* **1974**, 2509.
(b) Lounasmaa, M.; Massiot, G. *Planta Medica* **1978**, *34*, 66.
(c) Kan-Fan, C.; Lounasmaa, M. *Acta. Chem. Scan.* **1973**, *27*, 1039.

92. Mann, J.; de Almeida Barbosa, L.-C. *J. Chem. Soc., Perkin Trans 1* **1992**, 787.
93. Fierz, G.; Chidgey, R.; Hoffmann, H. M. R. *Angew. Chem. Int. Ed.* **1974**, *13*, 410.
94. MacDonald, T. L.; Dolan, R. *J. Org. Chem.* **1979**, *44*, 4973.
95. Boyer, F.-D.; Ducrot, P.-H.; Henryon, V.; Lallemand, J.-Y. *Synlett* **1992**, 357.
96. Meltzer, P. C.; Liang, A. Y.; Brownell, A.-L.; Elmaleh, D. R.; Madras, B. K. *J. Med. Chem.* **1993**, *36*, 885.
97. Carroll, F. I.; Gao, Y.; Rahman, M. A.; Abraham, P.; Parham, K.; Lewin, A. H.; Boja, J. W.; Kuhar, M. J. *J. Med. Chem.* **1991**, *34*, 2719.
98. Milius, R. A.; Saha, J. K.; Madras, B. K.; Neumeyer, J. L. *J. Med. Chem.* **1991**, *34*, 1728.
99. Bick, I. R. C.; Gillard, J. W.; Leow, H.-M. *Aust. J. Chem.* **1979**, *32*, 2537.
100. Einhorn, A. *Chem. Ber.* **1887**, *20*, 1221.
101. Carroll, F. I.; Lewin A. H.; Abraham, P.; Parham, K.; Boja, J. W.; Kuhar, M. J. *J. Med. Chem.* **1991**, *34*, 883.
102. Ducrot, P.-H.; Lallemand, J.-Y. *Tetrahedron Lett.* **1990**, *31*, 3879.
103. Ducrot, P.-H.; Beauhaire, J.; Lallemand, J.-Y. *Tetrahedron Lett.* **1990**, *31*, 3883.
104. Bemet, B.; Vasella, A. *Helv. Chim. Acta* **1979**, *62*, 1990.
105. Duclos, O.; Dureault, A.; Depezay, J. C. *Tetrahedron Lett.* **1992**, *33*, 1059.
106. Duclos, O.; Mondange, M.; Dureault, A.; Depezay, J. C. *Tetrahedron Lett.* **1992**, *33*, 8061.
107. Blattner, R.; Ferrier, R. J.; Haines, R. S. *J. Chem. Soc., Perkin Trans. 1.* **1985**, 2413.

108. Boyer, F.-D.; Lallemand, J.-Y. *Synlett* **1992**, 969.
109. Johnson, C. R.; Bis, S. J. *J. Org. Chem.* **1995**, *60*, 615.
110. Reingold, I. D.; DiNardo, L. J. *J. Org. Chem.* **1982**, *47*, 3544.
111. Dale, J. A.; Dull, D. L.; Mosher, H. S. *J. Org. Chem.* **1969**, *34*, 2543.
112. Kazlauskas, R. J.; Weissfloch, A. N. E.; Rappaport, A. T.; Cuccia, L. A. *J. Org. Chem.* **1991**, *56*, 2656.
113. McPhail, A. T.; Pinder, A. R. *Tetrahedron* **1984**, *40*, 1661.
114. (a) Pinder, A. R. *J. Org. Chem.* **1982**, *47*, 3607.
(b) Sahai, M.; Ray, A. B. *J. Org. Chem.* **1980**, *45*, 3265.
(c) Ray, A. B.; Oshima, Y.; Hikino, H.; Kabuto, C. *Heterocycles* **1982**, *19*, 1233.
115. Willstätter, R.; Wolfes, O.; Mader, H. *Ann. Chem.* **1923**, *434*, 111.
116. Lewin, A. H.; Naseree, T.; Carroll, F. I. *J. Het. Chem.* **1987**, *24*, 19.
117. Carroll, F. I.; Coleman, M. L.; Lewin, A. H. *J. Org. Chem.* **1982**, *47*, 13.
118. Findlay, S. P. *J. Org. Chem.* **1959**, *24*, 1540.
119. Findlay, S. P. *J. Org. Chem.* **1957**, *22*, 1385.
120. Bazilevskaya, G. I.; Bainova, M. A.; Gura, D. V.; Dyumaev, K. M.; Preobrazhenskii, N. A. *Izv. Vyssh. Uchebn. Zaved. Khim. i Khim. Technol.* **1958**, *2*, 75; *Chem. Abstr.* **1959**, *53*, 423h.
121. Stoll, A.; Lindenmann, A.; Jucker, E. *Helv. Chem. Acta* **1953**, *36*, 1506.
122. Fodor, G.; Vincze, I. W.; Toth, J. *J. Chem. Soc.* **1961**, 3219.
123. He, X.-S.; Brossi, A. *J. Het. Chem.* **1991**, *28*, 1741.
124. Fodor, G.; Kowacs, J. *J. Chem. Soc.* **1953**, 2341.
125. Fodor, G.; Vincze, I. W.; Toth, J. *J. Chem. Soc.* **1957**, 1349.
126. Hayakawa, Y.; Noyori, R. *Bull. Chem. Soc. Jpn.* **1974**, *47*, 2617.
127. Beckett, A. H.; Harper, N. J.; Balon, A. D. J.; Watts, T. H. A. *Tetrahedron* **1959**, *6*, 319.

128. Mirza, R. *Nature* **1952**, *170*, 630.
129. Willstätter, R.; Iglauer, F. *Chem. Ber.* **1900**, *33*, 1170.
130. Moriarty, R. M.; Prakash, O.; Vavilikolanu, P. R.; Vaid, R. K.; Freeman, W. A. *J. Org. Chem.* **1989**, *54*, 4008.
131. Atkinson, E. R.; McRitchie, D. D. *J. Org. Chem.* **1971**, *36*, 3240.
132. Bell, M. R.; Archer, S. *J. Am. Chem. Soc.* **1960**, *82*, 4624.
133. Clauson-Kaas, N.; Li, S.-O.; Elming, N. *Acta Chem. Scand.* **1950**, *4*, 1233.
134. Noyori, R.; Baba, Y.; Hayakawa, Y. *J. Am. Chem. Soc.* **1974**, *96*, 3336.
135. Noyori, R.; Makino, S.; Baba, Y.; Hayakawa, Y. *Tetrahedron Lett.* **1974**, 1049.
136. Daum, S. J.; Martini, C. M.; Kullnig, R. K.; Clarke, R. L. *J. Org. Chem.* **1972**, *37*, 1665.
137. Pham, V. C.; Charlton, J. L. *J. Org. Chem.* **1995**, *60*, 8051.
138. Wenzel, T. J. *NMR Shift Reagents*, CRC Press: Boca Raton, FL, 1987.
139. Parker, D. *Chem. Rev.* **1991**, *91*, 1441.
140. (a) Derome, A. E. *Modern NMR Techniques for Chemistry Research*, Pergamon Press: Oxford, 1987.
(b) Freeman, R. A. *Handbook of Nuclear Magnetic Resonance*, Longman: Harlow, UK, 1988.
141. Gupta, A. K.; Kazlauskas, R. J. *Tetrahedron: Asymmetry* **1992**, *3*, 243.
142. (a) Francis, P. G. *Mathematics for Chemists*, Chapman and Hall: New York, 1984.
(b) Harris, D. C. *Quantitative Chemical Analysis*, 2nd ed. W. H. Freeman and Company: New York, 1987.
143. Sullivan, G. R. In *Methods in Stereochemical Analysis*, Morrill, T. C. Ed.; VCH Publishers Inc, New York, Vol. 5, 1986.

144. *Asymmetric Synthesis*, Morrison, J. D. Ed.; Academic Press Inc: Vol. 1 *Analytical Methods*, Toronto, 1983.
145. Fodor, G.; Soti, F. *Tetrahedron Lett.* **1964**, 1917.
146. Rubottom, G. M.; Gruber, J. M. *J. Org. Chem.* **1977**, *42*, 1051.
147. Hardegger, E.; Ott, H. *Helv. Chim. Acta* **1955**, *38*, 312.
148. Leonard, J.; Lygo, B.; Procter, G. *Advanced Practical Organic Chemistry*; 2nd ed. Blackie Academic & Professional: Glasgow (Chapman & Hall: New York), 1995.
149. Still, W. C.; Khan, M.; Mitra, A. *J. Org. Chem.* **1978**, *43*, 2923.
150. Harwood, L. M. *Aldrichimica Acta* **1985**, *18*, 25.
151. *Handbook of Chromatography*, Zweig, G.; Sherma, J., Eds.; CRC Press Boca Raton, Florida, 1972; Vol 2.
152. Wittig, G.; Thiele, U. *Liebigs Ann. Chem.* **1969**, *1*, 726.
153. Borch, R. F.; Bernstein, M. D.; Durst, H. D. *J. Am. Chem. Soc.* **1971**, 2897.
154. Overberger, C. G.; Marullo, N. P.; Hiskey, R. G. *J. Am. Chem. Soc.* **1961**, *83*, 1374.
155. Keller, O.; Keller, W. E.; van Look, G. *Org. Synth.* **1985**, *63*, 160.
156. Ando, A.; Shioiri, T. *Tetrahedron* **1989**, *45*, 4969.
157. Shirai, R.; Aoki, K.; Sato, D.; Kim, H.-D.; Murakata, M.; Yasukata, T.; Koga, K. *Chem. Pharm. Bull.*, **1994**, *42*, 690.
158. Hobson, J. D.; McCluskey, J. G.; *J. Chem. Soc. (C)*, **1967**, 2015.
159. Montzka, T. A.; Matiskella, J. D.; Partyka, R. A. *Tetrahedron Lett.* **1974**, 1325.
160. Lounasmaa, M.; Pusset, J.; Sevenet, T. *Phytochemistry* **1980**, *19*, 949.
161. Bick, I. R. C.; Gillard, J. W.; Leow, H. *Aust. J. Chem.* **1979**, *32*, 2523.

162. Sinnema, A.; Maat L.; Van der Gugten, A. J.; Beyerman H. C. *Recueil* **1968**, *87*, 1027.
163. Campbell, H. F.; Edwards, O. E.; Kolt, R. *Can. J. Chem.* **1977**, *55*, 1372.
164. The Aldrich Catalog of Fine Chemicals 1994-1995.
165. Lin, Y. Y.; Jones, J. B. *J. Org. Chem.* **1973**, *38*, 3575.
166. Parr, A. J.; Payne, J.; Eagles, J.; Chapman, B. T.; Robins, R. J.; Rhodes, M. J. C. *Phytochemistry* **1990**, *29*, 2545.
167. Evans, W. C.; Major, A. J. *Chem. Soc. (C)* **1966**, 1621.
168. Bick, I. R. C.; Gillard, J. W.; Leow, H.-M.; Preston, N. W. *Aust. J. Chem.* **1979**, *32*, 2071.
169. Wharton, P. S.; Bohlen, D. H. *J. Org. Chem.* **1961**, *26*, 3615.
170. Luche, J.-L. *J. Am. Chem. Soc.* **1978**, *100*, 2226.
171. Hoffmann, H. M. R.; Haase, K.; Ismail, Z. M.; Preftitsi, S.; Weber, A. *Chem. Ber.* **1982**, *115*, 3880.
172. Normant, J. F.; Piechucki, C. *Bull. Soc. Chim. Fr.* **1972**, *6*, 2402.
173. Li, J.; Quail, J. W.; Zheng, G.-Z.; Majewski, M. *Acta Crystallogr.* **1993**, *C49*, 1410.
174. Trost, B. M.; Hiroi, K.; Kurozumi, S. *J. Am. Chem. Soc.* **1975**, *97*, 438.
175. Wang, P.; Yao, T.; Chen, Z. *Huaxue Xuebao* **1989**, *47*, 1002; *Chem. Abstr.* **1990**, *113*, 78746u.