

Home Distillation Handbook

**How to distil quality alcohol
at home inexpensive and safely**

By Ola Norrman (Pseudonym)

Ola Norrman

Home Distillation Handbook

Internet publishing: Bokforlaget Exakt, Malmoe

Photo setting: Bokforlaget Exakt, Malmoe

Set with: Times och Franklin Gothic

Drawings: Tord Haegg, Malmoe

Layout: Bokforlaget Exakt, Malmoe

Printed by: Bokforlaget Exakt in Malmoe 1999

Bokforlaget Exakt

Box 50336

202 13 Malmoe, Sweden

ISBN 91-970694-5-0

Please note that it is illegal to put to practical use the contents of this book in certain countries.

However home distillation is a good talking point, and acquiring such knowledge is an easy burden

© Bokforlaget Exakt, Box 50336, 202 13 Malmoe, Sweden.

Bokförlaget Exakt

ISBN 91 970694-5-0

Contents	5	Basic instructions	48
Copyright and Internet	6	What makes for a "good" Turbo?	49
Copyright	6	The key to making world-class spirits	49
Books downloaded from the Internet	6	Understanding the science of fermentation	50
Introduction	7	Yeast is a living organism	51
Natural home distillation	8	All about temperature	52
Equipment for fermentation	9	Different Turbo's www.partyman.se offer	53
Fermentation vessel	9	Some words from Gert Strand	54
Fermentation lids, rubber plug	10	A last trick to improve quality	55
Rubber caps, fermentation locks	11	Large volume fermentation	55
The syphon	12	Instructions for large volume fermentation	56
Measuring	13	Picture of Turbo yeasts	57
Hydrometer (with Oechslescale)	13	Mash fermentation with Turbo yeast	58-59
Hydrometer, instructions	13	Mash fermentation with baker's yeast	60-61
Measuring glass for alcometer and hydrometer	14	Distillation	62
Alcometer	14	Redistillation	63
Laboratory Thermometer	15	Fractional distillation	64-66
Quality in general on instruments	15	How to distill extra pure alcohol	66
Distillation apparatus	16	Temperature	67
The Still	16	Theoretical thresholds in distillation column	68
Distillation column filling	17	Actual location of thresholds	68
Counter-flow rinsing of column	18	Distillation procedure	69-71
Heat source for the still	18-19	Danger of accidents\important points	72
The thermometer	20	Implosion	72
Electronic temperature control	20-21	Explosions	73
2 reliable solutions that function well	21	Risk of fire, flooding	74
Lab-Master distilling apparatus	22	Poisoning	75
The boiling vessel	23	Trouble shooting	76
Distilling apparatus materials	24	Distillation fails to start	76
Thermometer connection point	25	Contaminated spirits flows from the apparatus	76
Column viewed from base	26	Spirit comes out but is not clear	76
Mounting of column filling retention strip	26	The mash surge boils	76
Fixing of column retention plate	27	Alcohol is too weak	77
Circulation of cooling water	28	Too little output	77
Quicker distillation	29	Dilution	78
Ingredients	30	Formula for calculating dilution	78
Quantities	30	Fusel oil	79-80
Water, sugar	31	Purification using activated carbon	81
Yeast	32	Procedure	82-83
Yeast nutrients	32	Different brands of activated carbon	83
Turbo Yeast	33	Activated carbon filtrat unit	84
Clearing agents (Finings)	33	Connoisseur method	85
Activated carbon	34	Purification several times through the same activated carbon	85
Activated carbon is always active	35-36	Purification must be perfect	85
How much activated carbon is used?	36	Blending with essences	86
Aquarium charcoal	36	Basic prerequisites	86-87
Deposits in the spirit	37	Blending with spirits essences	88
Essences	38-39	Blending with liqueur essences	89
The advantages of essences	40	Formula for calculating dilution	89
Which essences are best?	41	Table of original alcohol content of liqueurs	90
Liqueur extract and drink mixers	42	Original gravity of liqueurs	91
Fill Up essence	42	Original gravity of aperitifs and bitters	91
Drink mixers	43	Legislation	92
Literature about home distilling	43	Freedom of the press	92
Sources of essences	44	It is obvious	92
Mash fermentation	45	Punishment	93
Preparing the mash	45-46	Is the law wrong in your country	93
How much sugar is required?	47		
Purer fermentation with Turbo yeast	48		
Turbo's	48		

Copyright and Internet

Copyright

Reproduction of the contents of this book, in whole or part is forbidden, and is a breach of the Law of Copyright without the express permission of the author. Neither is it permitted to reproduce figures or illustrations and applies to all forms of reproduction, by copying, printing, duplicating, stenciling, tape recording, etc., and also includes copies of this book downloaded from the Internet.

© Bokforlaget Exakt, Box 50336, 202 13 Malmoe, Sweden.

Books downloaded from the Internet

Books downloaded from the Internet and bought and paid for are, in the case of a single copy the property of the purchaser. According to Copyright Law no book may be printed out and sold.

Where a book is purchased and one or more books remain, or are present on other media, for example as a file downloaded from the Internet, this is a breach of Copyright. It is forbidden to sell or give away such books in any form and at the same time retain an example in any form. The book is the property of the purchaser and can be sold once only providing the complete example is sold to the next purchaser, and no duplicate copies remain with the vendor.

Introduction



The Law on Freedom of Information makes possible the publishing of this book. That described in this book is still illegal in Sweden and in many other countries, and what "one" does in the book is not intended to tempt the reader. But knowledge is an easy burden and amateur distillation is free in several countries.

Pleasant reading.

The Author

PS

I would again like to stress that the contents of this book are not intended to encourage the reader to break the law. If it is illegal in your country to distill alcohol you should naturally not do so. This book describes the technical aspects of home distillation as it is practised in countries where it is legal.

Natural Home Distillation



Natural home distillation comprises mash fermentation followed by distillation and after-treatment. This can be split up into the following stages:

- * **Equipment**
- * **Ingredients**
- * **Fermentation**
- * **Distillation**
- * **Dilution**
- * **Purification**
- * **Flavouring**

Natural home distillation has been a tradition for many hundreds of years in Sweden. Domestic distillation has been taxed at various times, allowed or forbidden since the sixteen hundreds. Currently home distillation is forbidden and the processes covered by this book are illegal in Sweden. However, knowledge is not a heavy burden and home distillation is allowed in many countries of the world today.

Equipment fermentation

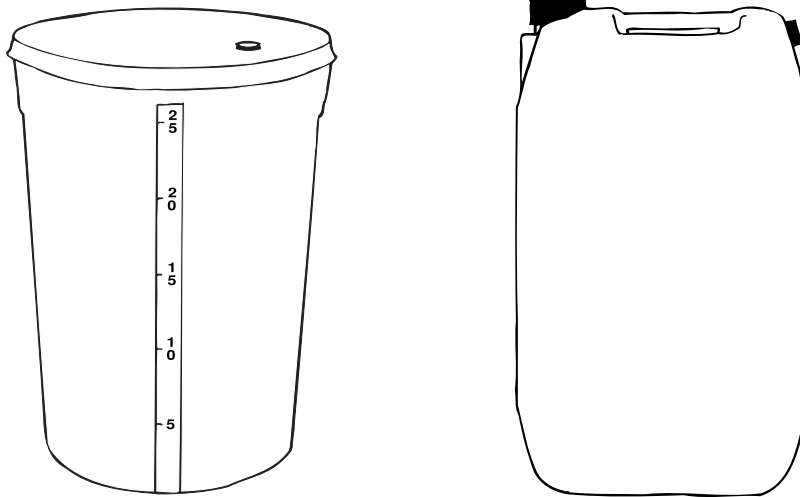

Fermentation vessel

One of the best fermentation vessels for mash is a winemaking container. These are graduated from 1-30 litres (or in pints and gallons) and the graduation is very useful. The lid is removable so that sugar can be dissolved directly in the water. The vessel is wide at the top so that the carbon dioxide leaves at the widest point, which speeds up fermentation. Such vessels are very easy to keep clean.

The next most useful type is a polythene container (a water container of the type used for camping) in white and approved for containing foodstuffs. This type of container is easier to handle than a glass demijohn and is much less fragile.

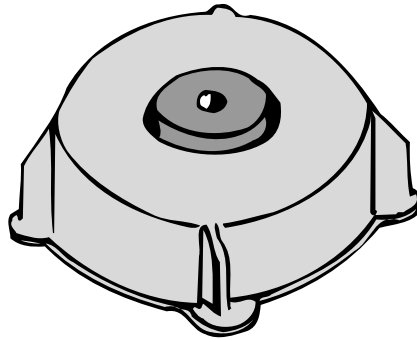

Fermentation lid

Lids or caps are available for plastic containers. They screw on and are provided with a hole and rubber grommet for the fermentation lock. These covers are *unsatisfactory*. They often leak or leak after a time.

Conical rubber plugs provided with a hole for the fermentation lock are better as they never leak.

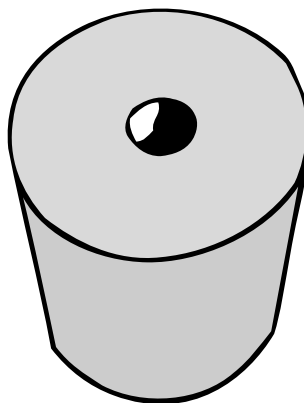

Rubber plug (Bung)

A rubber plug is better than a lid or rubber cap for plastic containers. A rubber plug (bung) never allows carbon dioxide to escape from around the fermentation lock. Larger rubber plugs are available for glass demijohns. These are good but often several times more expensive than rubber caps.

Rubber plugs (bungs) last 2-3 times longer than rubber caps.



Rubber caps

A rubber cap does not leak between glass demijohns and the fermentation lock. *However, note that rubber caps leak if they are used on plastic containers.* Even if they are sealed with wire or jubilee clips leakage will occur. It is suggested to use food grade bungs if possible.

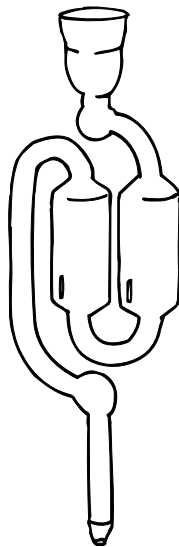

Fermentation lock

The fermentation lock should be of plastic. It contains a water trap that allows the venting of carbon dioxide but prevents the fermentation coming into contact with air. When fermenting with Turbo yeast or other rapid fermenting yeast a fermentation lock should *not* be used for the first few days. Fermentation will be so violent that the water will be forced out. The carbon dioxide, which is heavier than air, protects the fermentation from air. The fermentation lock should be fitted when the violent fermentation has subsided.

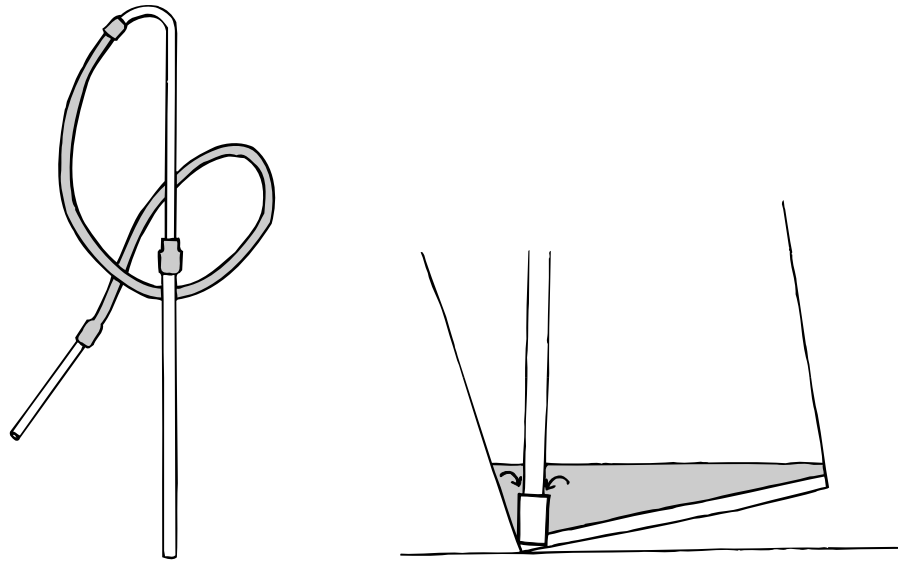

The syphon

Syphons should be of plastic. Syphons incorporating rubber tubes can cause off flavours if used for alcohol - which sometimes happens. The syphon is used for transferring the finished mash. The mash is transferred to the still but is designed to leave the yeast deposit behind. The syphon leaves about 20 mm of deposit behind in the fermentation vessel.

Measuring

The Hydrometer (with Oechslescale)

The Hydrometer indicates when fermentation has ceased in the mash. When the instrument shows -10° - -20 Oechsle (spec. gravity 980-990) or below (in the coloured field) the fermentation is complete. Fermentation usually starts at $+80$ (spec. gravity 1080) or higher. The hydrometer should be 300 mm long. It should be free floating, and read at the surface of the liquid. (Rather like checking the specific gravity of battery electrolyte).

Many different makes are available, mostly from China. One of the best makes is Widder from Germany. The hydrometer is the only way of determining that the mash fermentation has ceased. It is no indication when the bubbling from the fermentation lock ceases, as carbon dioxide can be leaking from somewhere.

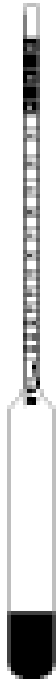

Hydrometer Instructions

Allow the hydrometer to float freely and read off from the surface of the liquid.

If one wants to know the alcoholic content of the mash the hydrometer must be used.

The hydrometer reading of the finished fermentation divided by 8 equals the percentage of alcohol by volume.

Example: Starting value = 80 (white field) and final value -16 (coloured field). Finished fermentation reading is 80 on the plus scale and 16 on the minus scale, giving 96 degrees. 96 divided by $8 = 12\%$, which is the alcohol in the mash.

If the hydrometer is graduated in specific gravity $+80^{\circ}$ Oechsle = 1080, -16° Oechsle = 984.

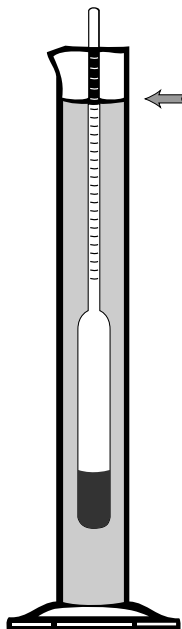

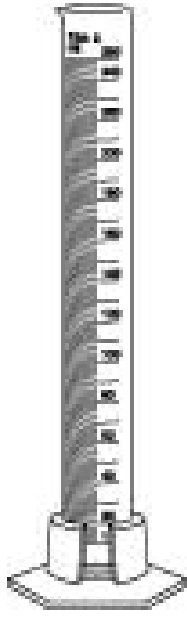

Measuring glass for the alcometer and hydrometer

Assuming one has a 250 or 300 mm instrument, a measuring glass is best. For a 250 mm instrument a 100 ml high glass is best, and for a 300 mm a 250 ml high glass is suitable. With a measuring glass it is not necessary to use so much spirits, and the glass will be the correct height. The measuring glass should be

graduated in millilitres so that it can also be used for measuring volume. With an alcoholmeter and a measuring glass much mixing and measuring can be carried out. Refer to sections covering dilution, essences, tables, etc.

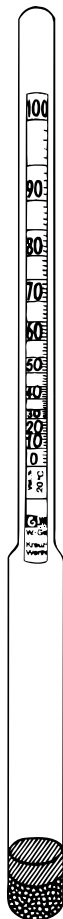

Alcometer

Measures the alcoholic strength of the distillate. Functions only in pure mixtures of alcohol and water. Graded from 0-100%. The alcohol meter functions in the same way as a hydrometer, it should be allowed to float on the surface of the spirits.

The longer the instrument is the more accurate it will read. One should not be satisfied with less than a laboratory model 250 to 300 mm long. These have an accuracy of $\pm 1\%$, whereas the shorter models of 150 mm can give a reading which is up to 15% wrong.

In the case of the short instruments the graduation is so fine that it is very difficult to read when showing under 50%. The alcohol meter shows the alcoholic content by volume. Instruments are available that are extremely accurate with a scale between 30 and 60%. One model also with thermometer. For exact reading 0,3% shall be added for each degree under and 0,3% deducted for each degree over 20°C . Widder, Germany is the leading brand.



Laboratory Thermometer

The most important task for the thermometer is to determine the temperature at the top of the column during distillation. When required it is also used to check the temperature of the fermenting mash. It is important that the thermometer is accurate at 78°C. It must be a finely calibrated spirit thermometer, and can be graduated in whole degree divisions. Thermometers can be obtained ranging from 40°C to 90°C with 2/10ths degree accuracy. These are considerably more expensive. The right temperature is of highly importance. Widder in Germany supplies thermometers that are calibrated at 78°C under the brand ACA.

Quality in general on instruments

Measuring instruments sold in department stores and home brew shops are usually made in the far east, have lower quality and are cheaper. Thermometers can be made calibrated during production or after you purchase them. After purchase, if used or not, the thermometer's calibration may be off by 5-15 degrees. The reason is poor (cheap) material and workmanship in those thermometers. Hydrometers and alcohol meters break very easy as they have to thin glass walls in some sections (It is already difficult enough not break quality items). Scale is not always fixed correctly and slides downwards or falls down to the bottom. Inaccurate readings of upwards of 10% occurs. Poor material and bad workmanships is common. But it can be difficult to see the difference. You have to buy in a real laboratory shop or demand quality from your supplier. Always buy well known name brands as Widder, Germany.

Distillation Apparatus



The Still

A still of stainless steel is to be preferred, and will virtually last a lifetime. This type of still is quite expensive to buy, but use brings no deterioration in value. Stainless steel always looks new.

A good still has a column. The column filling provides a good contact surface area, resistance that is not too high and good runback. A good stainless steel milking machine coupling is located between the column and the boiling vessel. The length of the column and the dimensions of the cooling tubes, etc. are designed so that high steam resistance is avoided. The apparatus is scientifically dimensioned so that when the spirit is exhausted the process stops. No more spirit comes out of the cooler.



Distillation column filling

A good column filling should be 5-8 mm in size, have a large surface area and be smooth (glazed, polished or glass) in order to impart a fast and even runback. Glass spheres (marbles) and the like are generally too large to give a good fractionation in the column. One can say that a column filling should be one tenth of the diameter of the column, but this is not absolutely correct. For example, with

5 mm glass spheres in a 50 mm wide column the vapour resistance will be too high. If the spheres are the right size, the surface area will be too small. The column filling is a once-only cost, so it must be correct from the start. Raschigrings of porcelain (should be glazed) are the best for 50 to 75 mm wide columns. They look like small pieces of cup tube and have an enormous surface area (both inside and out). The surface area is 930 against less than 300 for the corresponding spheres without holes through, and they are the best that is available.

Raschigrings are used widely as boiling stones (for distributing heat in boiling vessel) both in the chemical industry and for boiling wort, for example, where it is desired to keep an even and exact boiling rate. Raschigrings are available from specialist suppliers. 1 litre of filling is sufficient for a normal column (600 mm high and

50 mm in diameter). As a stopgap one can use the small glass cubes resulting from breaking safety glass (a toughened vehicle windscreen with plastic laminations between layers), brass, or stainless steel scrubs pads or lath fillings or 6 mm stainless steel nuts (expensive), etc.

If one wishes to compare the results of using Rachi rings and most other fillings the difference is as night is to day. Both the column and column filling must be cleaned thoroughly before each distillation, and must be cleaned after each distillation. A good cleaner is a winemaking cleaning agent used for cleaning of demijohns and bottles.

Counter-flow rinsing of column

After the apparatus has been used the column should always be rinsed out with (preferably hot) water. *One flushes water through the distillation channel in the opposite direction through the entire column.* This flushes out most of the impurities that have stuck in the column and column filling. Then it is a simple matter to remove the column filling for a thorough cleaning.

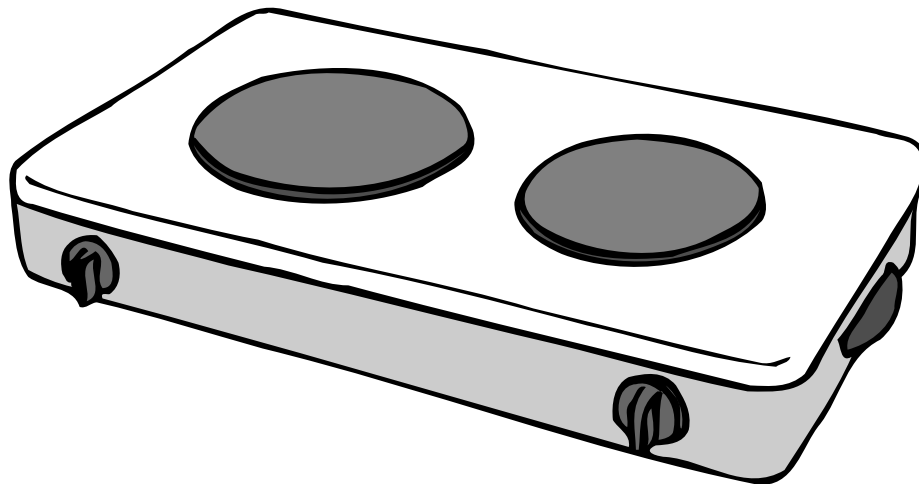

Heat source for the still

For a modern stainless steel still, both gas and electricity are suitable sources of heat, but electricity is safer to work with than an open flame. If the still has straight run-through cooling in the column the hotplate need not be infinitely variable. An ordinary boiling plate is suitable, but the best is a standard hotplate. These have a higher capacity. If the cooker has a cooker hood above it,

hindering placing the still upon it just roll out the cooker from the wall. 99% of domestic cookers are provided with castors. NOTE: *Hotplates with a thermostat are unsuitable* as the temperature is too variable, and

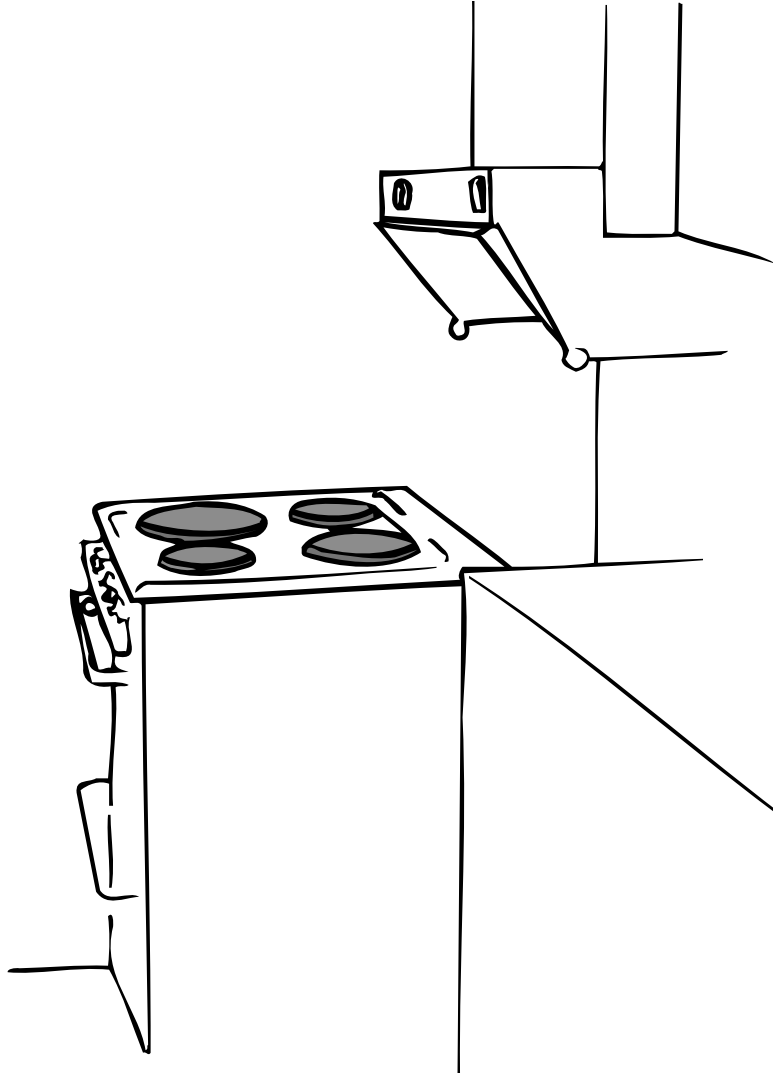

also the mash vessel will surge boil. An integral heating element is an *excellent* solution, but one must ensure that the mash vessel does not boil dry. If the element is not covered with liquid it will melt. A heating element heats the mash up faster and uses less electricity. For determining temperatures for various purposes and also for reading the column top temperature one usually uses a laboratory thermometer graduated from -10 to 100°C or thereabouts. A thermometer can give a false reading so test it in boiling water, which should read $+100^{\circ}\text{C}$. If the thermometer is not correct it will also read incorrectly at 78°C . Just make allowances for the error.



The Thermometer

The most important task for the thermometer is to determine the temperature at the top of the column during distillation. It is important that it is accurate at 78°C and is a finely calibrated spirit thermometer. Graduation in whole degrees is sufficient. Always buy a well known brand name or it can lose accuracy after a time and you get incorrect reading and spoil the control over the process and the quality of the spirit.

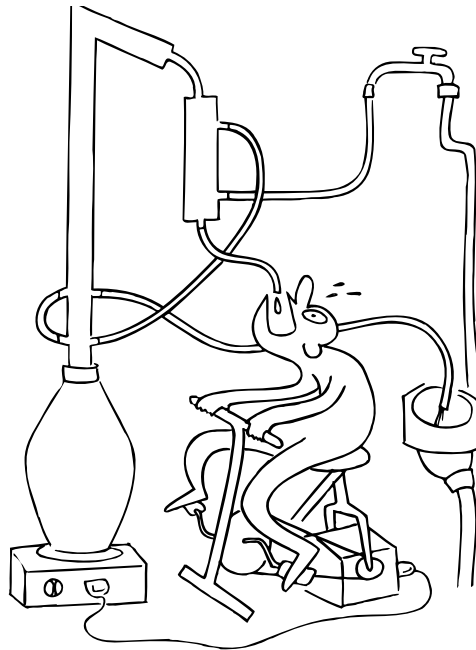

Electronic Temperature Control

The distillation apparatus functions satisfactorily without such equipment. Using equipment for automatic temperature control frees one from personally monitoring the temperature. Many types of such controls are available. A transducer is mounted in the top of

the column set at 78°C. It then controls the heating or the through-cooling (using solenoid valves) if the temperature becomes too high. Normally on the Lab-Master, no electronic temperature control is necessary. Of course it can sometimes be fun and need not cost a lot. The first solution is to put a thermostat in the top of the column. The thermostat then switches off the heating current if the temperature becomes too high. In practice this is not a good solution as the system is slow to respond as the thermostat requires a few degrees before responding. Distillation ceases as the heat source takes some time to heat up again on being once more switched on. Distillation will be 50% slower. The only use for such a system is as a "safety valve". If the temperature is set a few degrees too high or rises for any reason the thermostat will stop the distillation.

There are two reliable solutions that function well

1. A thermostat is placed in the top of the column. When the temperature becomes too high the thermostat switches off **THE LAST** element of the heat source. The distillation continues with a little less heat applied and does not stop in the "slow period". Then the thermostat switches on the current again, an inexpensive and effective solution.
2. An electronic temperature transducer is fitted in the top of the column. Note that this is a low voltage component and must be connected electronically.
When the temperature becomes too high the control redirects the current to the heat source via a rheostat (stepless power control) which is set to give slightly lower power to the heat source. This does the same thing as solution 1 but more accurately. An electronic temperature transducer is sensitive to one tenth of a degree, whereas a thermostat is accurate to 1-2 degrees. The electronic control can also be connected to a solenoid valve that opens an extra through-cooling in the column.

The LAB MASTER distilling apparatus

Illustrations



Column height 590 mm

Length of cooler 200 mm

Distance between first and second through-column 50 mm

Distance between the milking machine connector and the first through-column cooling tube 60 mm

Comments: One of the best units on the market. The length of cooler is only 200 mm because the manufacturer will not make it longer. This is to prevent too rapid distillation with consequent bad results (one soon reduces distillation speed if warm spirit starts to run). The cooler can be made 50 to 100 mm longer but this is not vital.



The boiling vessel

The boiling vessel is fabricated from two stainless steel buckets welded rim-to-rim of 10-15 litres capacity each. The capacity of the boiling vessel is 20-30 litres. If the base buckles outwards when stood on a hotplate hammer it carefully slightly concave with a mallet or similar.

If two stainless steel bread pans are used instead the boiling vessel will be lower and wider. This is almost better as heating up is quicker. The boiling surface (vapour area) is bigger and distillation is more rapid.

These are the two most used types of boiling vessels. By using bread pans or buckets which are manufactured as standard products one saves much money. Custom or special purpose fabricated vessels in stainless steel are quite expensive.

The boiling vessel can be designed differently to give a faster distillation (wide vessel with a broad column junction), but the increase in speed compared with a bucket or dough trough vessel is of no consequence.

Material

Austenitic stainless steel

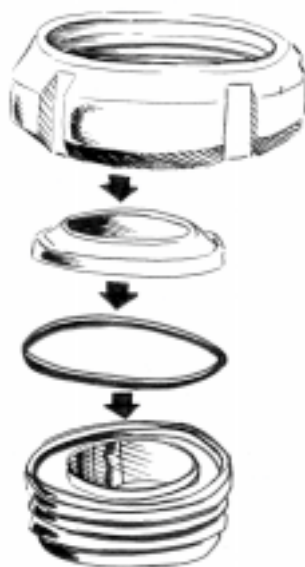
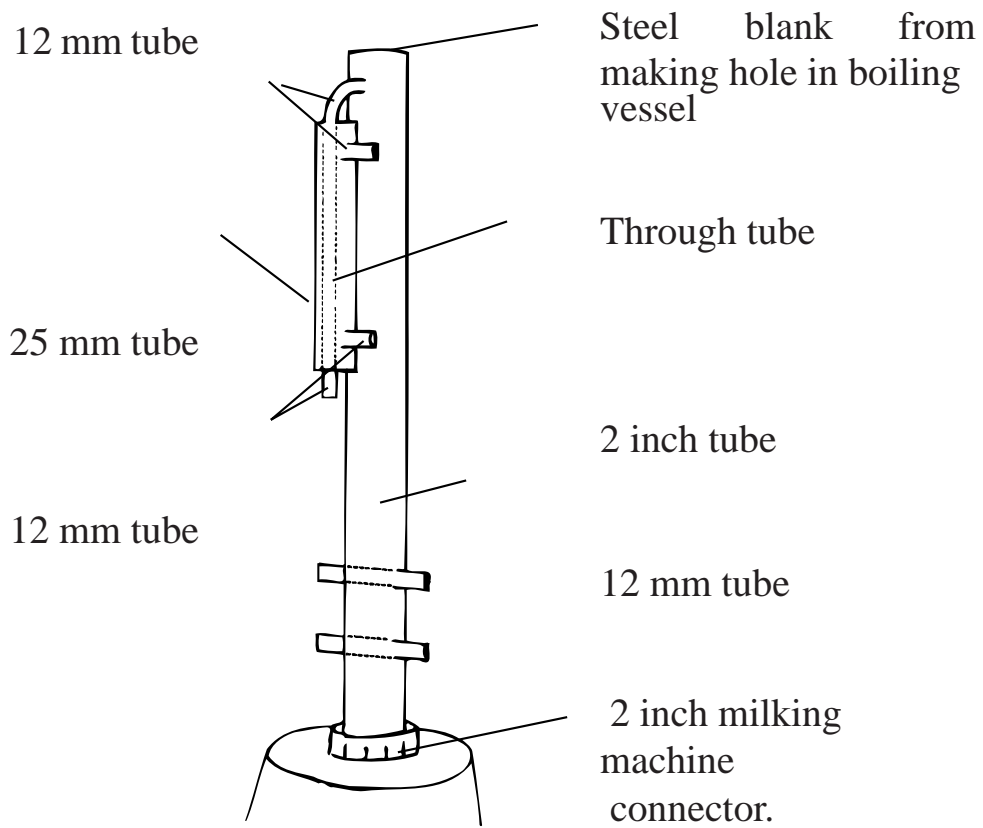

Milking machine connector



Thermometer connection point

The connection point is a 12 mm hole drilled in the top. In this a rubber grommet for the thermometer is placed. The same type as used in electrical equipment. An ordinary laboratory thermometer is inserted in the grommet.

As viewed from base of column.

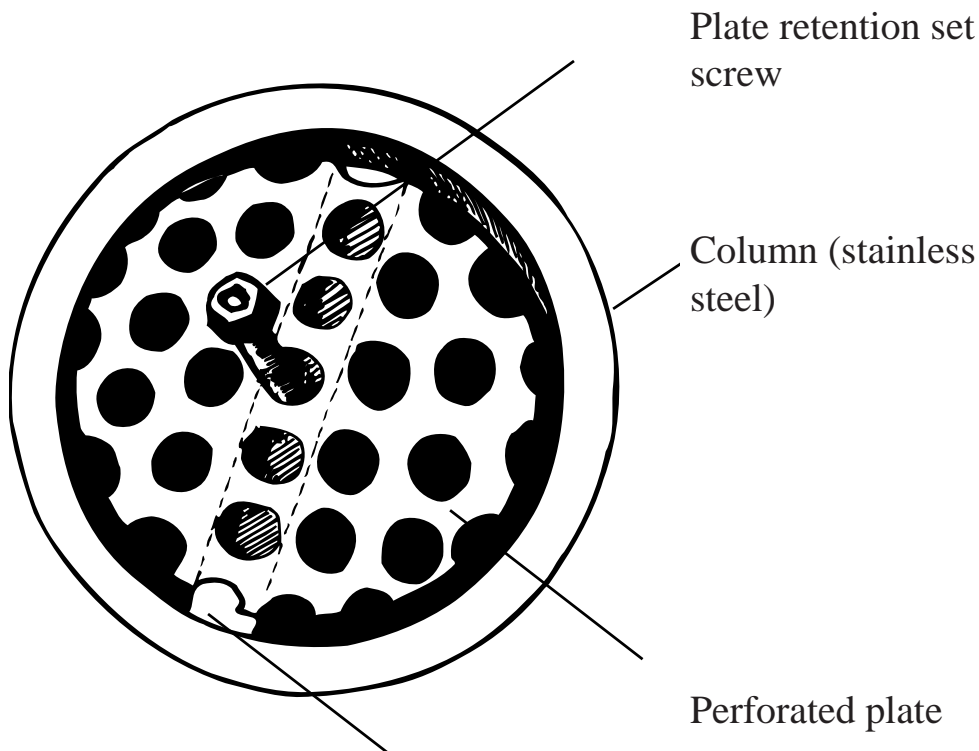

Strip welded at both ends mounted across column

Mounting of column filling Retention strip

A small strip of stainless steel is welded across the column, with fixing for a 5 mm stainless steel set screw. The plate for the retention of the column filling is provided with a centre hole as well as a number of other holes for the passage of the vapour. Place the plate with centre hole on to the set screw and retain with a stainless steel nut. The plate can subsequently be easily removed when the column filling is to be removed or filled.

Fixing of column filling retention plate



A small stainless strip is welded across the base of the column, onto which is welded a small stainless steel set screw. The perforated plate is then attached to this.

The perforated plate is provided with a centre hole which receives the set screw and a stainless steel nut holds the perforated plate, which in its turn retains the column filling.



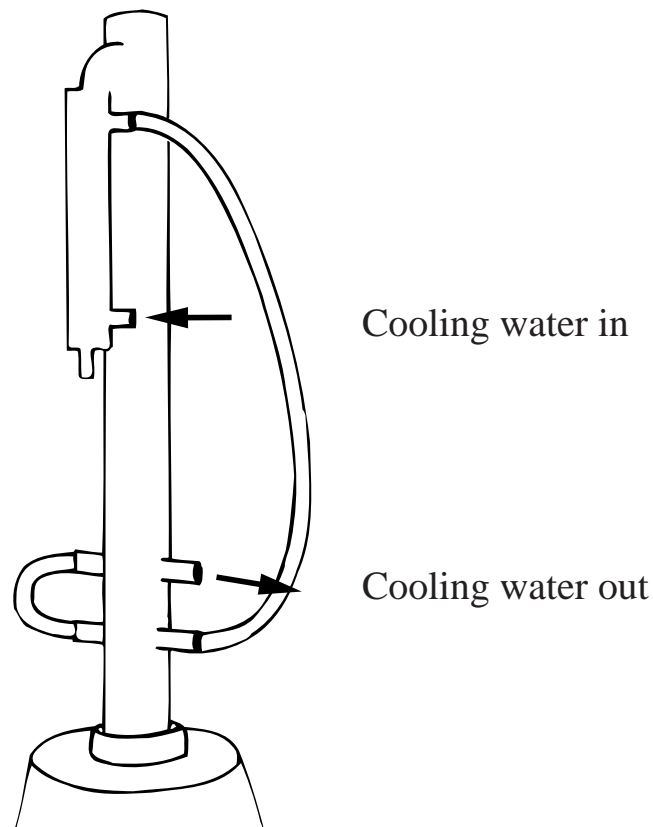

Circulation of cooling water

To ensure perfect distillation it is necessary for the cooling water to circulate in the correct direction. The cooling water is to pass into the base of the cooler, through the discharge point at head of the cooler and then through to the lower through-cooler. Then on to the next upper through-cooler (and then to the next, where provided) and on to the drain. This sequence ensures that the coldest cooling water is provided in the correct sequence.



Quicker distillation

The distilling sequence is slow and many want to speed this up without reducing the quality of the end product. In the case of proprietary apparatus there is not much that can be done, but for the DIY enthusiast there are a number of things that can be done. Starting from the base, a low broad boiling vessel (two dough troughs) offers quicker vaporisation than the usual twin stainless steel bucket type. Then one can increase the diameter of the column from 2" to 2 1/2". The volume of the column will be considerably increased and the vapour resistance reduced. And a reduction in resistance increases distillation speed.

A significant resistance for the vapour is when it goes from the column to the cooler and "falls over the edge". This is also a critical point where temperature is monitored. From the wide tube of the column the vapour has to enter the smaller tube of the cooler. If the column is cut here at an angle and the part cut off downwards at an angle (as illustrated) a transition area is obtained that is the same width as the column. Finally, one can increase the dimension of the cooling tube. Between the innermost and outermost tube of the cooler there should be as little space as possible. This allows the water to flow through quickly and cooling is efficient. Column lengths of over 600 mm are very difficult to heat up and give a slow distillation. But 600 mm is sufficient to give good results.

Ingredients

Quantities

The quantities given in this book are Metric, which is the system used in Scandinavia. Equivalents are as follows:

METRIC	USA	UNITED KINGDOM
1 litre	1.06 US quart	0.88 quart
1 kilogramme	2.20 US pounds	2.20 lbs.
1 hectogramme	3.50 oz	3.50 oz
1 gramme	0.56 drams	0.56 drams
12 mm	0,468 inch	0,468 inch
25 mm	0,975 inch	0,975 inch
51 mm	1,989 inch	1,989 inch
59 mm	2,39 inch	2,39 inch
12 mm	1/2 inch	1/2 inch
25 mm	1 inch	1 inch
51 mm	2 inches	2 inches
59 mm	2,4 inch	2,4 inch
1 cm = 0,39 inch	1 inch = 2,54 cm	1 inch = 2,54 cm
1° Centigrade	34° Fahrenheit	
20° Centigrade	68° Fahrenheit	
30° Centigrade	86° Fahrenheit	
78° Centigrade	147° Fahrenheit	

CONVERSION

$$\text{Fahrenheit} = \text{°C} \times \frac{9}{5} + 32$$

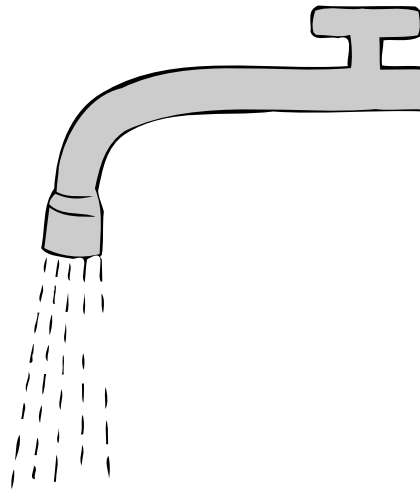

Water

We use ordinary tap water. Water supplied by the Water Board contains chlorine which can sometimes hinder the start of fermentation. If such is the case the water can be filtered through a half decilitre of activated carbon. It can also be allowed to stand in the fermenter for a day prior to using starting the fermentation. Stirring with a large mixing paddle or oxygenating with a aquarium bubbler will also reduce chlorine content. We run the water from a tap with an aerator or from a shower head to oxygenate the water.

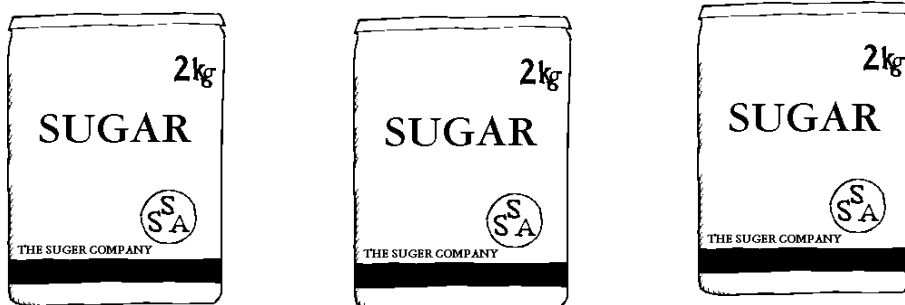

Sugar

We use ordinary granulated sugar.

Yeast

We use ordinary baker's yeast, usually fresh packet (blocks) from a baker or yeast supplier. Dry yeast is just as good. Much yeast sold is a by-product of the alcohol industry and is supplied to the bakery trade in large blocks.

Yeast Nutrients

In order to feed the yeast and to reduce the production of fusel oil we use yeast nutrients. The most important nutrient for yeast is nitrogen. Usually one adds 25-50 grams of ammonium carbonate or ammonium phosphate for the fermentation of 25 litres of mash. With rapid fermentation, however, Turbo yeast gives a faster and purer fermentation.



Turbo Yeast

To achieve a faster fermentation **Turbo yeast** is used. It is available in a number of brands, e.g., Turbojast, Alcotech, Turbo 3 and Norsk Turbo. Fermentation will be completed in 2-3 days, depending on how much sugar is used and the temperature, giving an alcohol content of 11-14%. To obtain a stronger mash **Gold Turbo 8 kg** is one of the best. It does what is claimed of it and gives a mash containing 16% alcohol, in optimum cases 18%. This means 50% more spirit from the apparatus with the same quantity of mash.

Clearing Agents (Finings)

When the mash has fully fermented it must clear. The mash will clear of itself if it is cooled down, it is just a question of waiting. To speed this process up a clearing agent is used, of the same type as is used for wine.

The mash is transferred to another fermentation vessel, leaving the yeast deposit. A clearing agent is added. Clearing is very rapid taking from 4 to 24 hours. Clearing can be speeded by cooling, placing the mash in a cool or cold location.

Mash that has been fermented using Turbo yeast usually clears quickly without the need to use a clearing agent. After clearing the, crystal clear mash is transferred over to the distilling apparatus with a syphon. The bottom deposit (lees) are then discarded.

Activated Carbon

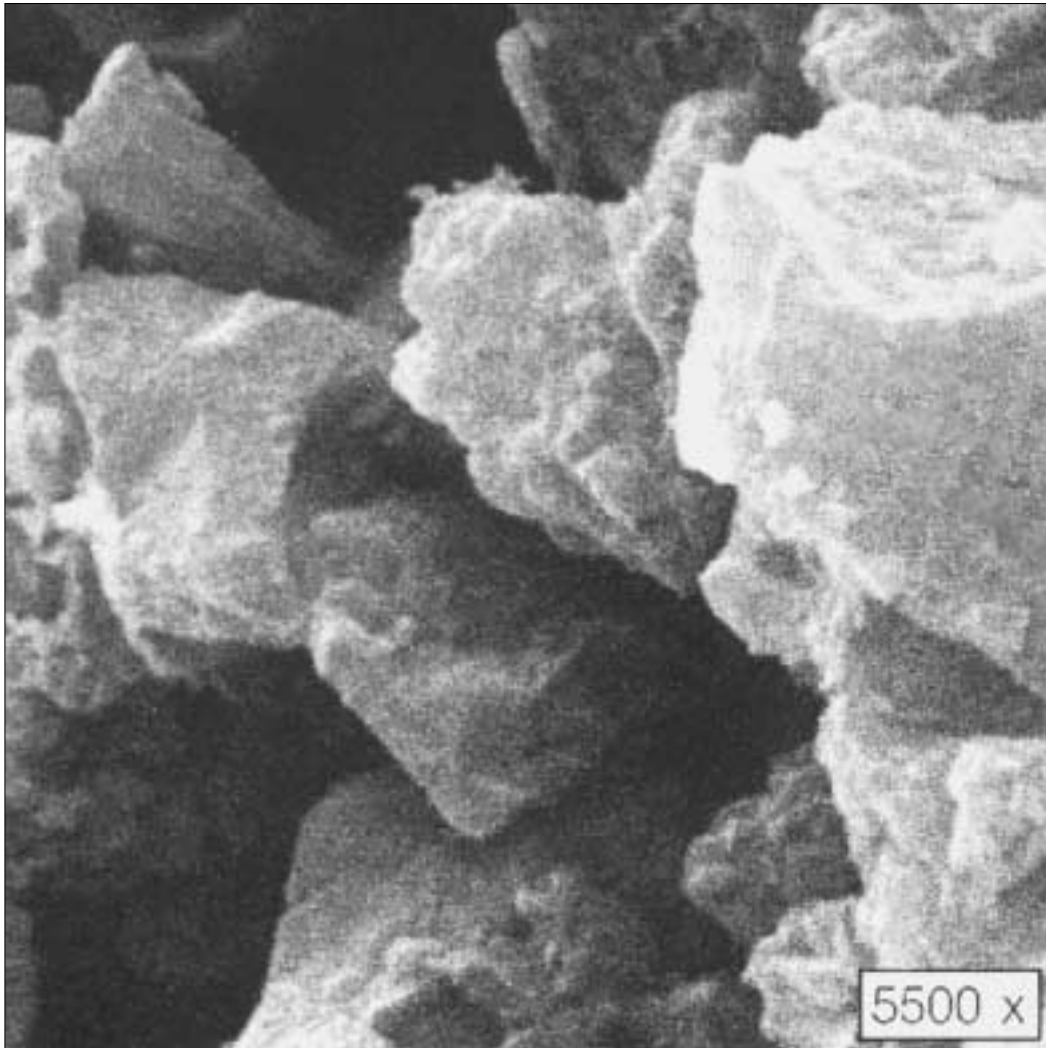

Activated carbon is available in hundreds of different forms that are characterized by their absorption structure and special porous makeup. The carbon gets its characteristics from the method of manufacture and the basic raw material. The carbon absorbs impurities by virtue of many different effects. The carbon is very porous with a large surface area, usually 500-1200 square metres per gramme. The pores can be described as an enormous number of naturally occurring cracks or pores that have randomly fused together into a coherent structure. Carbon can be compared to small sponges where impurities fasten in the holes.

Absorption comprises an interaction of the exterior and interior surfaces that powers the active strength. Carbon has chemical, physical and electrostatic attributes.

Activated carbon can be made from crushed coal or made from various materials such as wood, coconut husk, peat or by-products of the oil industry. Ordinary coal is not active and contains many substances such as tar, etc. When coal is used as a fuel these substances give off heat. When activated carbon is made ordinary carbon is heated to a very high temperature of over 1000°C. The various substances are driven off as gas and leave the carbon. The process also charges the carbon electrically. What remains is a spongelike porosity. Certain substances in various raw materials are driven off at different temperatures, and using this effect the porosity can be controlled. In order to make further pores steam at 130° C is injected into the carbon. By selecting the raw material, temperature and form of treatment (steam, hydrogen superperoxide, etc.,) the appearance of the pores, the number of pores, (measured in square metres per gramme, usually being between 500 and 1 200) and the electric charge can be tailor made.

Raw materials differ in weight, thus coal, for example, weighs twice as much as peat, which for the same volume gives it double the price for the carbon. Certain materials contain a large amount of substances that are removed by steaming, thus giving a big absorption area. These pores are tailor made for the purpose (they are formed so that fusel oil, etc. fit exactly in the pores). In consequence there are only a small number of suitable forms of activated carbon for purifying alcohol. Apart from the pores formed so that the relevant impurities are trapped in them, the activated carbon is also electrically charged. Impurities fasten onto the surface of the carbon as though magnetically attracted. When filtering through a tube do not filter through twice, as the second time the impurities attracted to the outside of the particles will be removed.

*Apart from the structure of the carbon, three other factors are significant: particle size, contact time and contact area. Refer to: **Purifying with activated carbon.***

Activated carbon is always active

Activated carbon is electrically charged (can be compared to a magnet) and always remains active. However, it can happen that the carbon can be *saturated* with impurities. When saturated there is no

room to absorb the impurities, both in the pores and on the surface. If the impurities are removed the carbon will function again. Regeneration is more expensive than buying fresh activated carbon, so using new activated carbon is cost effective in the domestic context.

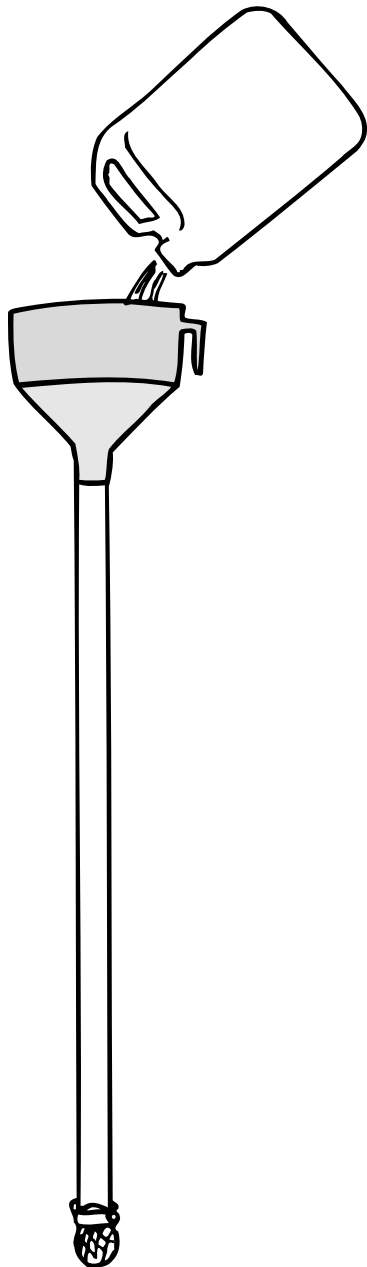

How much activated carbon is used?

Most types of carbon have the same characteristics. 1.8 to 2 litres is sufficient for 4-5 litres of 40% spirit. Some brands can purify double this amount. **THE BEST** purifying method is by filtering through a carbon layer through a long tube. The tube usually takes about 2 litres of activated carbon.

Sometimes purification is not perfect. Filtering again with new carbon will give brilliant results. The new carbon will retain most of its absorption ability and can be used as the first filter for the next distillation. This method costs only one portion of carbon.

Aquarium charcoal

Note that aquarium charcoal cannot be used with satisfactory results. It is manufactured from the most varied of raw materials, such as animal bones, blood, sphagnum moss, etc. Its purifying efficiency is very poor and the Grain size is unacceptably coarse. The use of cheap raw materials means that the charcoal some times imparts off-flavours, and can even leave the alcohol tasting worse than if it had been unfiltered.

Deposits in the spirit

Sometimes a deposit is seen in the spirit. Usually this is calcium and minerals from the water used for dilution. Soft or mineral free water should *always* be used for dilution. Certain type of activated carbon can give a grey carbon deposit in the spirit. Sometimes this can be cured by re-cycling the first half litre. It is also important to use a good quality filter paper.

Essences



Essences

Briefly about the background to essences:

In the commercial spirits industry many products are flavoured with essences. This is very common but little known by the general public. Such essences are of high quality and impart a good flavour (whisky and brandy are improved by the addition of 10% of the real thing).

Essences have been developed almost to perfection. As a consequence, even the essences intended for home use have been improved, as they are a consumer version of the commercial ones. Many buy Vodka and essence and blend a good drink more cheaply, especially in Scandinavia.

Essences are manufactured from various raw materials, often working with oils, concentrates or solutions of the original

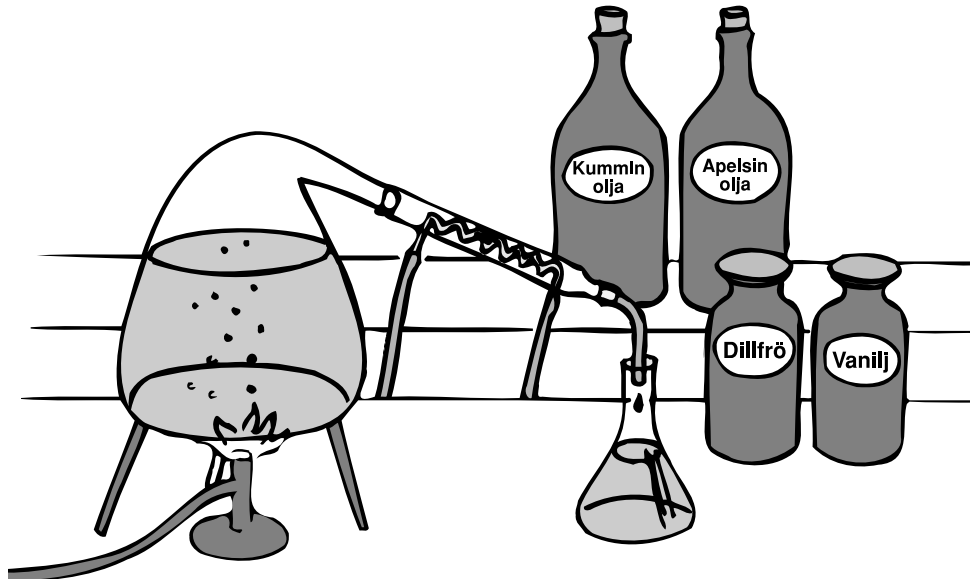

substances. These can be, for example: brandy oil, coffee oil, orange oil, caraway oil, dill oil, oil of aniseed or natural fusel oils. Also with these are herbs, oak and spices. Sometimes these extracts are distilled so that they are stronger and purer. The large international aromatics companies also offer finished essences such as gin and rum. There are also aromatics made by analyzing natural aromas and then manufacturing identical artificial substances. There are also synthetic aromatics, but these are used less and less. The technology is advancing at a very rapid pace, giving products of a quality one could only dream of just five years ago. A new technique, carbon dioxide distillation is the process behind many of these advances.

If we take a rum essence, this can, for example, comprise one or several base aromatics that are rum flavoured. Each of these aromatics can be made from a large number of ingredients. The rum flavour can then be tweaked with oils, vanilla, oak extract, spice extract and maybe a little glycerine and cane sugar molasses. On top of this, sometimes concentrated rum, if possible, will be added. Burnt sugar (Sugar colour E150) is used both for colour and for fullness and taste. The process can take a long time, sometimes many years to develop a good essence. Often hundreds of samples are used. Gert Strand in Sweden is the leader in essences, which are sold under the brand name **PRESTIGE ESSENCES**. Refer to the Internet at www.partyman.se.



The advantages of essences

All spirits stored in oak casks contain fusel oil. This is part of the aroma of brandy, whisky, dark rum, etc. Excess fusel oil intensifies a possible hangover. Spirits blended from essences contain little or no fusel oil, hence one is more likely to feel fine the next day, unless one has drunk far too much, at which point they will suffer from alcohol poisoning by upsetting their body chemistry. For making liqueur, essences are superior to using fresh fruit. All liqueurs (except coconut where the flavour is attenuated naturally with storage) made with essences can be stored indefinitely. If fresh fruit is used shelf life is limited to 3-6 months. Flavour can be better with essences, which are often made with natural raw materials selected for fine flavour, suitable for making liqueur, and subsequently concentrated. Precise amounts of vanilla and other refined ingredients are also added. It is cheaper to have essences in stock at home than finished spirits, as essences can be stored for years without problem. If one has some bottles of essences at home, most tastes can be catered for, from a cold gin and tonic to Skane akvavit for the pickled herring, and a "Hot Shot" Italiano. A "Hot Shot" with 1/2 Italiano and 1/2 Sambuca is good, and a "Hot Shot" with Hazel nut liqueur is really the tops.



Which essences are best?

In the opinion of the author the **PRESTIGE** essences from Gert Strand, Malmö, Sweden, are in a class of their own. Prestige essences are also sold to the liqueur industry in bulk.

Gert Strand also produce essence for alcopops. This essence contains the flavour that forms when alcopops are fermented. The essence is blended with spirit and about 4 cl of the mix is added to a glass to which is added a 33 cl bottle of mixer. The result is a superb alcopop with no taste of the spirit. **Winecoolers** were introduced at the same time using the same system.

Winecoolers have no taste of spirits and are very good.

Liqueur extracts and drink mixers



Fill Up - The concept that succeeded

Today most liqueur extracts are sold as Fill Up bottles. The bottles simply contain the correct amount of extract. One just fills the bottle with spirit and the liqueur is ready. This method is simple for the customer and ensures success.

I consider **PRESTIGE** Fill Up the best on the market. **Fill Up** extracts are the latest method for mixing your own liqueurs. One buys a bottle of extract, the amount of extract varies from type to type. One only needs to fill up the bottle with 40% spirit and the flavour, sweetness and final alcoholic strength will be correct.



Drink mixers and cocktail mixers

In my opinion HISAB drink mixers and cocktail mixers are the best. Sold in liquid form in bottles as per the Fill Up concept. Only sold in Fill Up bottles. Those are only sold in Scandinavia. Bartenders instant mixes are also very good and sold world-wide. Made in USA.

Literature about home distilling

The author also recommends the book "Making Gin & Vodka" by John Stone, www.gin-vodka.com.

Places where one can buy essences

Sources

There are many places one can buy essences and accessories. The most usual are the Internet, mail order, specialist shops, hardware stores and department stores. Look on the net at www.destill.com, (remember the Italian spelling) where there is information and links to retailers of Original Prestige Essences. Or fax +46 40-183025 or write to Gert Strand AB, Box 50221, S-20212 Malmo and enquire.

If you are a retailer, wholesaler or importer:

I recommend you to contact those companies in Europe if you want to sell super quality products

Gert Strand AB

Box 50221

S-202 12 Malmoe. Sweden

Fax.: +46 (0)40 18 30 25

Internet: www.destill.com

Prestige essences, Prestige activated carbon, Turbo yeast, Raschigrings and more. Manufacturer of essences. Wholesaler for German quality laboratory instruments. .

Franz Widder GmbH

Lengfurterstr. 35

D-97889 Kreuzwertheim am Main, Germany

Fax: +49 9342 21 122

Stainless steel stills of German super quality. Glass instruments.

Mash fermentation

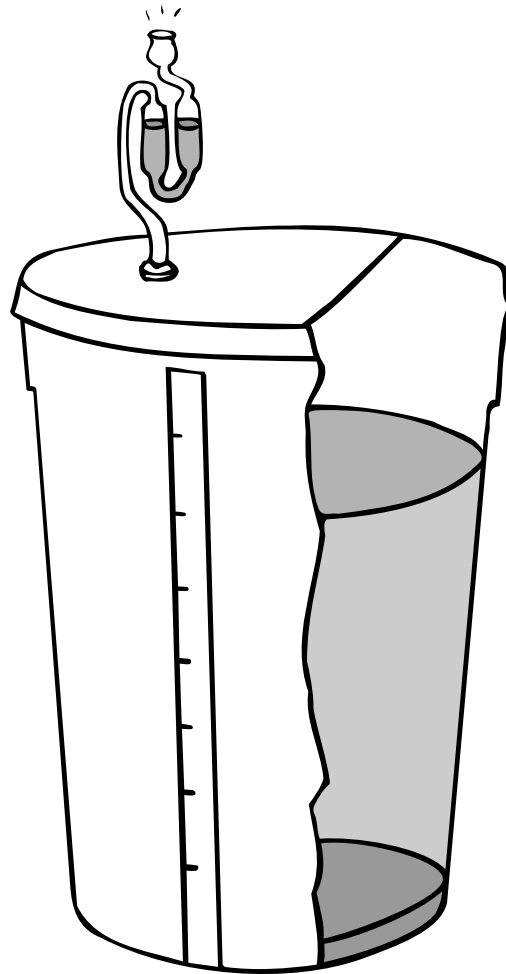

Preparing the mash

In principle, mash is cheap wine with no demands concerning taste. Only the alcohol is required, but the mash must contain as few impurities as possible, in order to give good results. Later the alcohol is removed by distillation. The purest and most simple mash is comprised of sugar, baker's yeast, yeast nutrient salts and water. The yeast "consumes" the sugar and produces carbon dioxide and alcohol. The carbon dioxide bubbles out through the fermentation lock and the alcohol remains in the mash. But the yeast cannot "consume" endless quantities of sugar. If the concentration of sugar or alcohol is too high the yeast cannot work. Ordinary baker's yeast, which we use, can ferment the mash up to 13%, then fermentation stops. Baker's yeast cannot work in a higher concentration of alcohol. To add more sugar than can be converted by the yeast is nothing but wasteful.

Mark the quantity of mash to be fermented on the outside of the fermentation vessel. Allow a headroom of 20 cm, otherwise the mash will foam over.

So that the sugar is fermented properly it must be completely dissolved in the water. 17 grammes of sugar gives 1% alcohol in one litre of mash. A 200 mm space should be left above the mash to allow for foaming. A 25 litre container cannot ferment 25 litres, but nearer 20-22 litres.

During fermentation the yeast consumes the sugar, leaving two by-products, alcohol and carbon dioxide. The carbon dioxide "plops" out through the fermentation lock and the alcohol remains in the mash. So that the yeast is able to last as long as possible, it must be given optimal conditions. The yeast starts best when it is given oxygen-rich water from a nozzle. It is then given the best possible nutrition in the form of a yeast nutrient salt and a temperature of between 20-25°C. The fermentation process adds heat of about 5°C. If the temperature falls below 18°C fermentation will stop until the temperature rises once more. A large surface area for the fermentation helps the carbon dioxide to leave the mash (so don't fill demijohns up to the neck). Fermentation can be speeded by shaking the mash to get rid of the carbon dioxide, but do not shake rapidly fermenting yeast or the mash will leave the container. A bigger fermentation, for example in a container of 100 or 200 litres ferments more rapidly than a smaller fermentation. At 11-13% alcohol, the yeast rests and sinks to the bottom. This can be speeded up by using a wine clearing agent. The clear mash is then transferred to the distillation apparatus and is distilled. Cleared mash must not stand on its lees for more than 3 weeks. It should be removed from the lees before the lees cause souring or oxidization. Where a mash does not ferment violently a fermentation lock filled with water must be fitted.

The fermentation lock prevents air from coming into contact with the mash. If this happens the oxygen in the air will oxidize the alcohol to acetic acid. During fermentation the carbon dioxide, which is heavier than air, protects the mash like a protective cover.

This is again a reason to leave 200 mm of space between the cover and the surface of the mash.

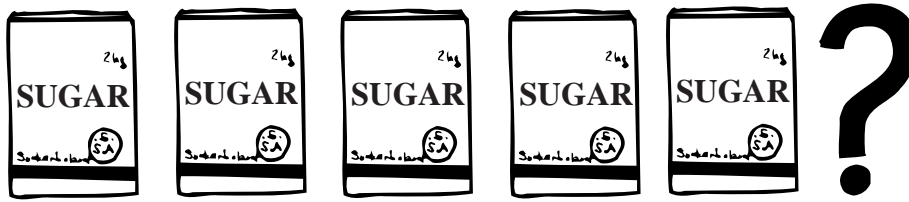

How much sugar is required?

Bakers yeast only manages to ferment up to 13% alcohol. 17 grammes of sugar gives 1% alcohol in 1 litre of mash. More sugar cannot be fermented out, so it is unnecessary to add more.

221 grammes per litre of mash is used (13 x 17 grammes).

20 litres of mash needs 4.5 kg sugar

21 litres of mash needs 4.7 kg sugar

22 litres of mash needs 4.9 kg sugar

23 litres of mash needs 5.1 kg sugar

24 litres of mash needs 5.3 kg sugar

25 litres of mash needs 5.5 kg sugar

26 litres of mash needs 5.8 kg sugar

27 litres of mash needs 6.0 kg sugar

28 litres of mash needs 6.2 kg sugar

29 litres of mash needs 6.4 kg sugar

30 litres of mash needs 6.6 kg sugar

With no scales sugar can be measured with a litre measure. 1.15 liters of granulated sugar weighs 1 kg.

Special yeasts are available (Gold yeast 8 kg Turbo, Willes 10 kg Turbo) that can ferment up to 16-18% alcohol. Measure how many litres are to be fermented, then calculate number of litres x 18% alcohol x 17 grammes sugar. Example: 22 litres of mash is to be fermented: $22 \times 18 \times 17 = 6.732$ g sugar or about 7 kg. Dissolve sugar in hot water until it is a syrup, then fill up to 22 litres with cold water and add the yeast.

Note that baker's yeast and ordinary Turbo yeasts cannot ferment out more than 12-14% alcohol. Only high alcohol-tolerant yeasts can manage this, but take longer, 1-2 weeks and liquid temperature may not go over 26°C.

Purer fermentation with Turbo yeast

By using "Turbo yeast" (the generic name) it is possible to ferment a mash with more alcohol and less volatiles in a short time. The first Turbo widely sold was probably "Superjasten" (The Super yeast) by Gert Strand in Sweden, over 10 years ago. The following information about Turbo yeast is copied from www.partyman.se with the permission of Gert Strand.

Turbo's

A Turbo is a mix of yeast and complex nutrient which will ferment a pure sugar solution into alcohol quickly. There are 2 types of Turbos, one making 14% of alcohol in 3 days and one making 18% of alcohol in 7 days. With this 18% yeast one will get 50% more alcohol from the same distillation. With the 14% type you will get a fast distillation and 2-3% more alcohol than with bakers yeast. Both types of Turbos give less volatiles than with bakers yeast.

Basic instructions;

- 1.** Dissolve sugar (usually 6 kg) in warm water, then fill up with cold water to give a volume of 25 Litres. The sugar must be completely dissolved to be able to ferment to alcohol.
- 2.** Add the Turbo sachet contents then leave some where warm for a few days for the yeast to convert all the sugar into alcohol (called fermentation). Using 6 kg sugar you end up with a liquid (called the "mash" or the "wash") of approx. 14% alcohol.

The crystal clear mash is then drawn off and distilled to concentrate the alcohol to as near to 95% v.v. ethanol as possible and then treated with activated carbon to remove off-flavours and smell. More will be said about these instructions later.

What makes for a "good" Turbo?

It should be able to ferment to 14% alcohol in 3 days even when the temperature is not ideal (see later) equally important is that the mash produced contains only a small amount off-flavours or smell (the volatiles). The benefits of a rapid fermentation are obvious, but the importance of making a clean mash may not be so obvious since later treatment with activated carbon should remove these volatiles anyway. An explanation follows;

The key to making world-class spirits and liqueurs in the home

1. First make clean, pure ethanol.
2. Then use the best available essences to convert it.

A common mistake is to try to copy the traditional way spirits and liqueurs are commercially made. You will fail unless you use all the same raw materials, the same equipment, the same process control and the same maturing processes. Get just one thing wrong and your result will be nothing like the commercial drink you are trying to match. To illustrate what I am saying, look what happens when a Scotch whisky manufacturer changed just one detail of his traditional process;

Ten years ago this Scotch whisky maker decided to buy a new still. He went to great expense to ensure the new stainless steel still was exactly the same shape and size as his old copper one, knowing full well that any changes to shape or size would alter the character of his whisky. The new still was installed and the virgin whisky (before maturation) was produced exactly as it had been before. The virgin whisky produced had an unpleasant turnip-like smell! The scientists could not explain why the move from copper to Stainless steel made such a difference, they put some copper back in the still to solve the problem!

So unless you can copy everything down to the last detail, you will fail. In this case "Simplest is best" use white granulated sugar and a good Turbo!

Understanding the science of fermentation

You don't need to understand the science of fermentation to make good spirits and liqueurs in the home unless you want to experiment with the fermentation system i.e. fermenting larger volumes or higher alcohol levels. So, if you intend to be sticking to the instructions, to the letter (see later) then skip this section. Seeing fermentation from the yeast's perspective helps in understanding the science.

Yeast is a living organism actually very similar to the individual cells in our own body. It is easy to think of dried yeast as "just another ingredient" like the nutrients or the sugar but nothing could be further from the truth.

Yeast's sole aim in life is to reproduce, it does this by "budding" to produce a daughter cell identical to the parent.

Given a plentiful supply of oxygen, sugar, minerals, enzymes and amino acids it will reproduce itself every 30 minutes and you will end up with a bucket full of yeast! Take away the oxygen and you get much less growth and a bucket full of alcohol.

As far as the yeast is concerned, sugar is a source of energy the yeast cell imports (eats) a sugar molecule eg.

Glucose which has 6 carbon atoms joined together by chemical bonds it breaks these bonds one by one, each time liberating energy which is used for growth.

Without oxygen it can only break just one bond and so liberates only a little energy (so only a little growth), what's left is thrown out of the cell as a waste product this is ethanol. So, if you want to make alcohol, keep the oxygen out!

To grow, yeast also needs amino acids, enzymes and minerals as well as the energy it extracts from sugar. These are needed to build new proteins (by creating bonds between amino acids) and carry out the many enzymatic reactions within the cell. A good Turbo sachet will contain all of these essential growth ingredients collectively we call these "yeast nutrients". If you have ever tried to ferment pure sugar with just yeast, you will know that you get very little alcohol, this is because yeast needs these other nutrients as well as sugar.

Yeast is a living organism

So yeast is a living organism which uses sugar to make energy for growth. If there is no oxygen around yeast cannot extract all the energy from sugar and throws out ethanol as a waste product. To function, yeast also needs amino acids, enzymes and minerals which collectively we call nutrients. As well as throwing out ethanol as a waste product, yeast throws out another 1300 other compounds which we can call "volatiles". These volatiles fall into chemical categories;

Higher alcohols (also called Fusel oils)

Esters

Carbonyl compounds

Organic acids

Sulphur compounds

All fermented alcoholic drinks contain these volatiles, whether made in the home or made commercially. Indeed, it is basically the amounts and types of these volatiles that make say dark Rum taste and smell like dark Rum, or that make whisky taste and smell like whisky. Now this is important to make clean, pure ethanol in the home we don't want these volatiles. This is why activated carbon is used after distillation, to remove these volatiles. But, even the best activated carbons will not remove a large amount of volatiles so it is important to try not to make them in the first place. The choice of yeast strain and nutrients have the greatest influence on keeping volatile production to a minimum. *The only control you have here is to buy a good Turbo sachet.* It is the Turbo manufacturers job to select the best yeast strains for the job and use the correct nutrition. However, the temperature you use through out fermentation, and the activated carbon used all influence volatile concentration.

All about temperature

There are two types of temperature we need to talk about;

- 1: The air temperature
- 2: The liquid temperature

Because yeast generates heat during fermentation, the liquid temperature will be higher than the air temperature. The difference between the two will increase as the volume you are fermenting increases. High temperatures will kill yeast. Where there is no alcohol yeast dies at 40°C but as the alcohol increases this "killing temperature" decreases. At 14% alcohol (which is what you get using 6 kg sugar in a 25 L volume) the killing temperature drops to 33°C and at 20% alcohol down to 25°C. 17 grams of sugar ferments to 1% of alcohol in 1 liter mash. Providing you keep the liquid temperature below 30°C all the way through fermentation (25°C for very high alcohol) you will not kill the yeast. This is easy with volumes up to 25 Litres because the difference between air and liquid temperatures is only a few degrees. But it is not so easy to keep the liquid temperature below 30°C when fermenting larger volumes you either need to keep the heat generation down or cool the liquid by say introducing frozen 5 L water containers after about 12 hours into the fermentation. Gold Turbo 200 sachet has been designed with this problem in mind, it is "fully stackable" up to 200 L so use 1 sachet for 25 L, 2 for 50 L etc up to 8 sachets for 200 L. Above 200 L you need to introduce cooling or use fewer sachets (eg 16 sachets for 600 L). You should now understand why it is important to keep the liquid temperature below 30°C. There is another reason to keep the liquid temperature below 30°C - to keep volatile production down to a minimum. In fact, the lower the fermenting liquid temperature, the lower the volatiles. So you could say "the cooler the better" however, in practice the amount of volatiles produced at a very cool temperature like 15°C is not much less than at say 25°C But there is a huge difference in fermentation time, at 25°C fermentation of 6 kg / 25 L will take 3 days but at 15°C it will take nearly 2 weeks!

To keep down production of volatiles a liquid temperature of 25°C is recommended.

Different Turbo's www.partyman.se offer

This is copied (with permission) from Internet. There are more companies world-wide offering those Turbos.

Turbo Gold 200. To make 14% ethanol in 3 days, use 1 sachet + 6 kg sugar in 25 Litres or use 8 sachets + 48 kg sugar in 200 Litres (or anything in between e.g. 5 sachets + 30 kg sugar in 125 Litres etc).
Turbo 8 kg To make 18% ethanol in 7 days, use 1 sachet + 8 kg sugar in 25 Litres. It is not recommended to scale up to larger volumes unless you have good control of liquid temperature.

Turbo Gold 200 instructions for 25 Litres.

- 1.** You need a 30 L sized plastic bucket, clean it with hot water (it does not need to be sterilized unless it is very dirty). Calibrate to 25 Litres if it is not already graduated.
- 2.** The point of this step is to end up with a final volume of 25 Litres which contains 6 kg sugar and has a start liquid temperature of around 25-30°C. First add either 5 Litres boiling water or 10 Litres hot water into the bucket. Add 6 kg ordinary white granulated sugar (sucrose) and stir until completely dissolved (about 2 minutes). Now top up to 25 Litres with mains cold water and stir well for 2 minutes to ensure an even sugar solution. Ideally the cold water used for topping up should be between 15-20°C although water as low as 5°C can be used, this will just make the fermentation 1-2 days longer.
- 3.** Add the sachet contents and continue to stir until no more particles of yeast are visible to the naked eye. The liquid should have a milky appearance with no bits in it.
- 4.** Now leave it at warm room temperature (around 20-25°C is best) to ferment for 3 days. Any air temperature between 18°C and 30°C can be used but the time taken for fermentation will be different. At 30°C it will take only 2 days (but make more volatiles!) and at 18°C it will take 7 days.
- 5.** After fermentation this "mash" should be distilled, diluted to 40% ethanol then passed through activated carbon to remove volatiles before adding essences. See elsewhere for further details.

**Some words from Gert Strand at
www.partyman.se**

This is copied (with permission) from Internet. There are more companies world-wide offering those Turbos.

There are many manufacturers of Turbos and frankly, there is only one who is that excellent. Our policy is to sell top quality world-wide. All Turbos we sell are variations from this very excellent producer. For example, the nutrient of a certain Turbo contains 22 different ingredients. Some competitors only contains one ingredient, ammonium phosphate. Another example: some competitors yeast ferment much faster when you use a mono sugar like grape sugar (glucose) or fruit sugar (fructose). Turbos we sell ferments sucrose (ordinary household sugar, sucrose) with the same speed. All those Turbos are also designed to make as few volatiles as possible. To make a good Turbo you need a great deal of know how. To make a bad Turbo you need only bakers yeast and ammonium phosphate. You can be sure that I am serious about this. The first widely sold Turbo here, and probably in the whole world, was my product, SUPERJASTEN. I have *not* sold this since 1996 because it was no longer, in my honest opinion, the best. Today I have sold this Trade Mark and do not sell this product. Scandinavia is considered worlds leading market in essences, activated carbon and yeast. To give an example, one of our competitors have sold essences for 100 years. Many products has been invented here. I will produce a Turbo again and work to get maximum quality. But we will not rush with this as we have these superior products to sell under Trademark such as Alcotec and others.

For the future, yeast scientists are working very hard. The strains used today are natural and so it will be for a while. New strains will tolerate higher temperatures and higher alcohol contents and make less and less volatiles. After this, genetically manipulated strains will take over. Then it will be possible to ferment 25% alcohol, a liqueur, maybe even more. How long this will take is impossible to know. My estimation is that it will occur within 10 years from today, but no sooner then 5 years. Kindest regards Gert Strand

A last trick to improve quality

When the mash has fermented out completely (use a Hydrometer to check), let it clear until it is crystal clear. Then draw off the mash with a siphon, leaving all yeast and impurities in the fermentation vessel. By this method you have a crystal clear mash without yeast to distill. The mash should be able to clear by itself in a day or two. You can speed this up by adding a clearing agent for wine or place the mash in the cool. The mash must have fermented out completely before clearing.

Large volume fermentation

1. Instructions to make more than 200 Litres using Gold Yeast 200. The larger the volume the more difficult it gets to keep the liquid temperature below the lethal 37°C. The best number of sachets to use is as follows;

<u>Fermentation Volume</u>	<u>No of sachets</u>	<u>Sugar (sucrose)</u>
200 Litres	8	48 kg
250 Litres	9	60 kg
300 Litres	10	72 kg
350 Litres	11	84 kg
400 Litres	12	96 kg
450 Litres	13	108 kg
500 Litres	14	120 kg
600 Litres	15	144 kg
700 Litres	16	168 kg
800 Litres	17	192 kg
900 Litres	18	216 kg
1000 Litres	19	240 kg

Instructions for large volume fermentation

- 1.** Dissolve required amount of sugar into the same volume of hot water (e.g. use 48 Litres hot water to dissolve 48 Kg sugar). Make sure the sugar has completely dissolved before continuing.
- 2.** Top up to final volume with cold water, continue to stir until the liquid specific gravity is 1090.
- 3.** Make sure the liquid temperature is below 25°C then add relevant number of Gold Yeast 200 sachets. Continue to stir until no more yeast particles are visible.
- 4.** Allow to ferment at 15-20°C air temperature for 3 days.

NB. Make sure the liquid temperature is kept below 35°C throughout fermentation.

Introduce frozen CONTAINERS of water after 12 and 24 hours to reduce liquid temperature if necessary.

I do not recommend the use of high alcohol Turbo's after reflection for any volume above 25 Litres.

For larger volumes the liquid temperature must be tightly controlled between 24 - 26°C and this will not be possible in practise even by the most experienced people.



Turbo Gold 200 yeast.

Willes 8 kg Turbo yeast

Mash fermentation with Turbo Yeast

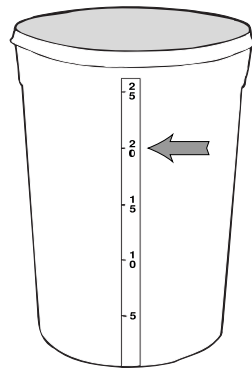

1. MARK OUT THE VOLUME

Mark a level mark on the fermentation vessel indicating how many litres are to be fermented. Remembering to leave at least 200 mm for foaming.

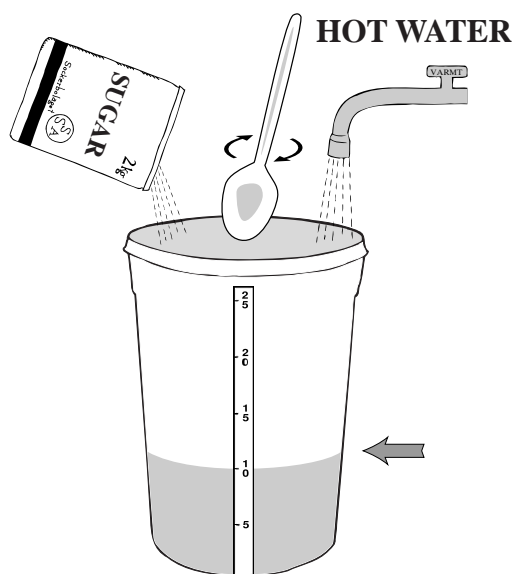

2. MIXING

Add 10 litres of hot water from the hot water tap to the fermentation vessel. Add the sugar. Shake or stir until the sugar is completely dissolved. *NOTE: the sugar must be completely dissolved before it can be fermented to alcohol.*

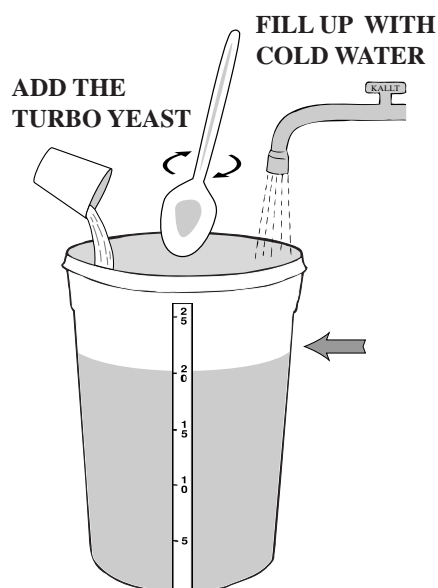

3. ADD YEAST

Fill up the fermenting vessel with cold water, preferably oxygen rich water from a spray head. Fill up to the level marking. Add the Turbo yeast and shake vigorously. Fermentation will start in a few hours. Put the cover on without using the fermentation lock.

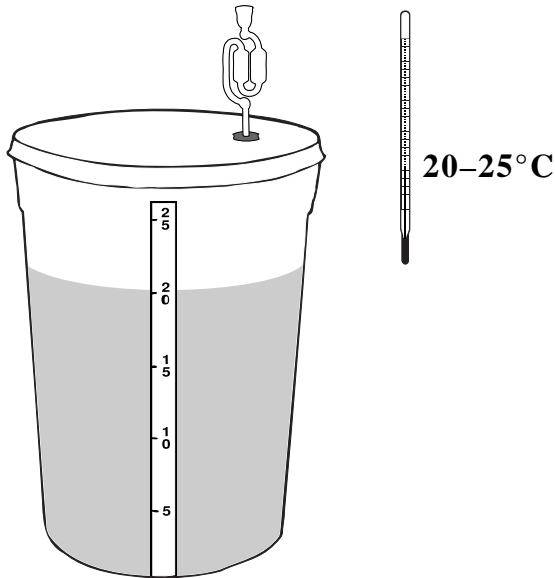

4. FERMENTATION

Fit the fermentation lock with water in it after 2 days fermentation and press tight the cover. If water is ejected from the fermentation lock by the speed of fermentation, wait 1-2 days before refilling.

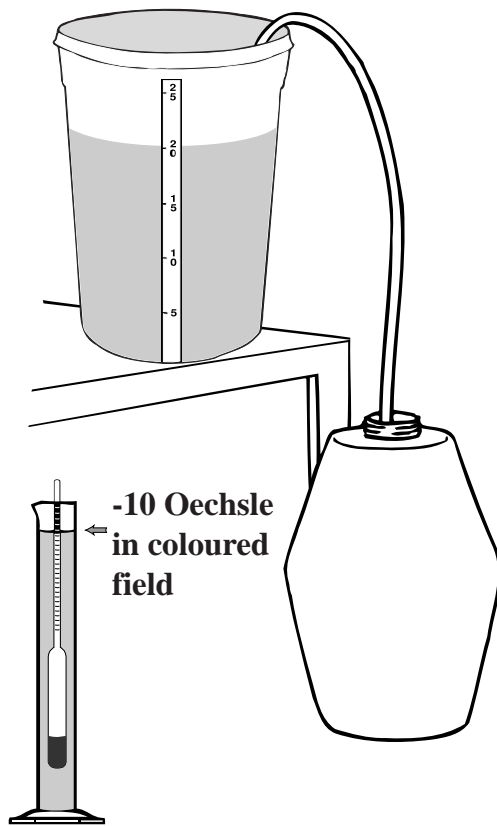

5. TRANSFERRING

When the fermentation has stopped, take a reading with the hydrometer. This should read -10 - -20 (coloured field, spec. gravity 980-990). If the mash is crystal clear transfer to the distillation vessel. If the mash has not cleared transfer to another vessel, ensuring the lees are left behind. Then simply wait a few days and the mash will clear. If time is a problem use a clearing agent for wine. This works in 4-24 hours. Transfer the clear mash to the distillation apparatus, ensuring the lees are left behind.

Mash fermentation with baker's yeast

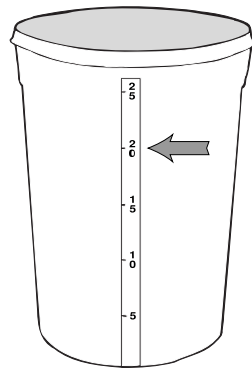

1. MARK OUT THE VOLUME

Mark a level mark on the fermentation vessel showing how many litres is to be fermented. Remembering to leave at least 200 mm for foaming.

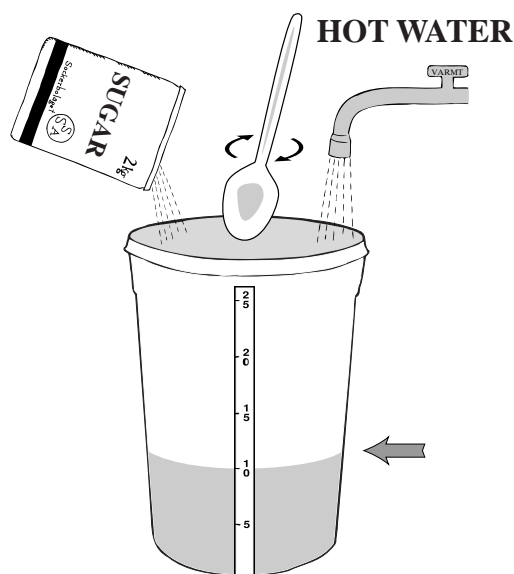

2. MIXING

Transfer 10 litres of hot water from the hot water tap. Add the sugar. Shake or stir until the sugar is completely dissolved.

NOTE: sugar must be completely dissolved to be fermented to alcohol.

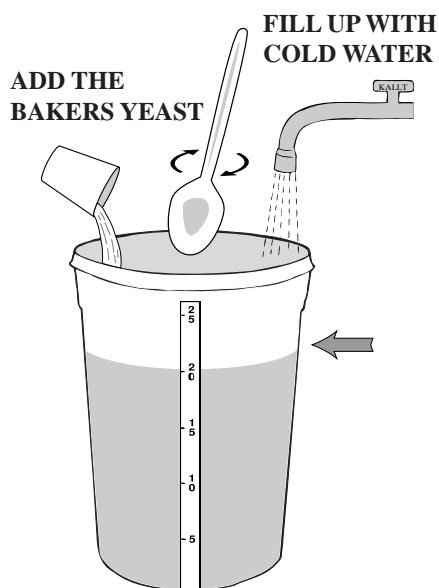

3. ADD YEAST

Fill up the fermentation vessel with cold water, preferably oxygen rich water from a spray head. Fill to the level mark. Add the yeast and yeast nutrients. If fresh baker's yeast is used dissolve in a tea cup of granulated sugar and 2 decilitres of water first. Shake to mix well. Put the cover on without using the fermentation lock.

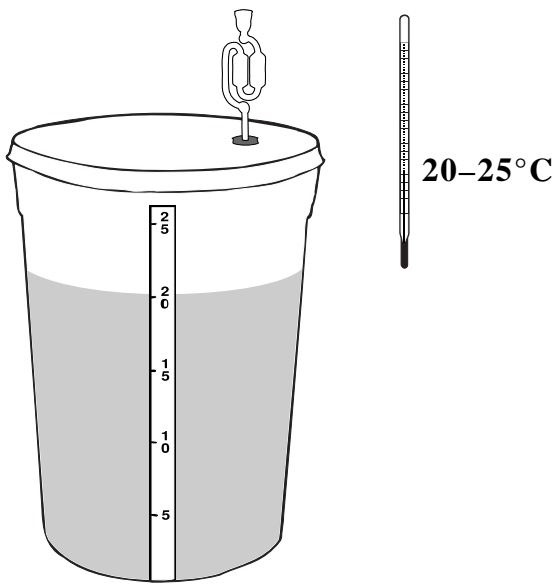

4. FERMENTATION

Fit the fermentation lock with water in it after 2 days fermentation and press tight the cover. If water is ejected from the fermentation lock by the speed of fermentation, wait 1-2 days before refilling.

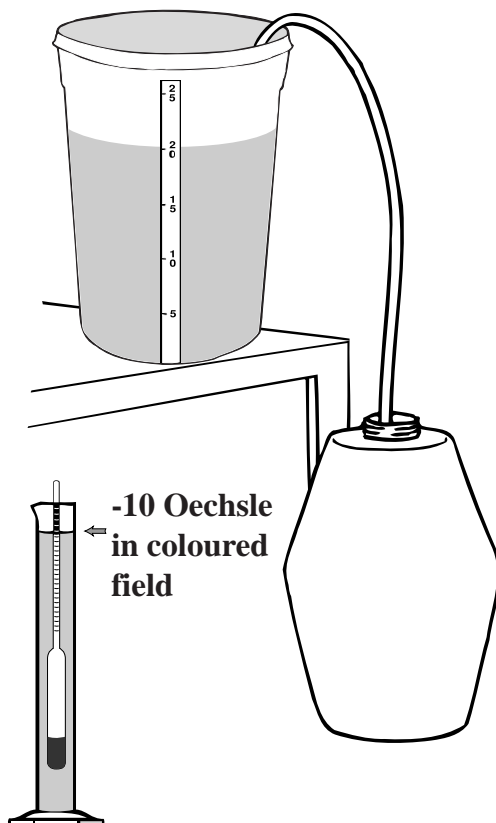

5. TRANSFERRING

When the fermentation has stopped, take a reading with the hydrometer. This should read -10 - -20 (coloured field, spec. gravity 980-990). If the mash is crystal clear transfer to the distillation vessel. If the mash has not cleared transfer to another vessel, ensuring the lees are left behind. Then simply wait a few days and the mash will clear. If time is a problem use a clearing agent for wine. This works in 4-24 hours. Transfer the clear mash to the distillation apparatus, ensuring the lees are left behind.

Distillation

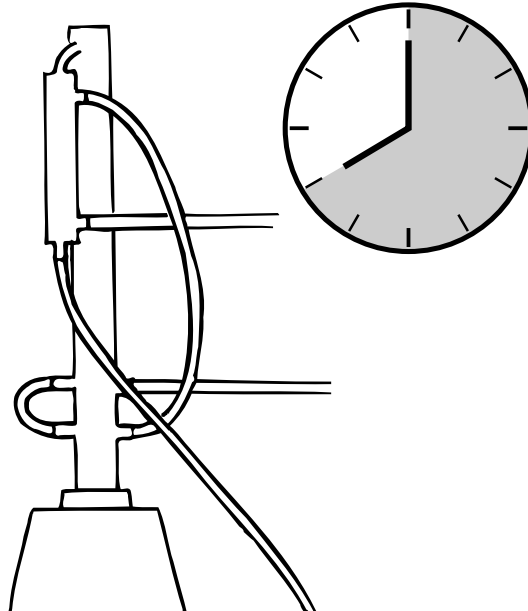

The principle of distillation is that one heats up the mash to boiling point and cools down the steam (condensation) to a liquid. Alcohol has a lower boiling point (78.3°C) than water (100°C) and so boils first. By this means the alcohol is separated from the mash.

The strongest alcohol possible to achieve by distillation is 95%. This is because a mixture of 95% alcohol and 5% of water has a lower boiling point of ($78,15^{\circ}\text{C}$) then 100% alcohol ($78,3^{\circ}\text{C}$). This is called an azeotrope.

Redistillation

As a rule only one distillation is required. If one wishes to distil twice usually one distils once quickly, dilutes the resultant distillate with water to 50% and redistils. The second time slowly and accurately (78°C).

After this the alcohol should be diluted to a maximum of 50%, or preferably less and is then filtered through activated carbon. This gives a very satisfactory result and the first distillation is done very quickly. If one wishes to distill twice with better results, the best is to double distill as perfectly as possible at the correct temperature for the initial distillation and then dilute to 38-42% (activated carbon has its maximum purifying effect at about 38-42% alcohol) and purify through activated carbon according to my instructions. Before the second distillation one should wash out the boiling vessel, distillation column and extra carefully the column filling, using a good wine cleaning agent or other proprietary cleaner. Then the spirit should be redistilled at exactly the right temperature. This will give a pure strong alcohol (95%) because the distillate has already been purified in activated carbon. A prerequisite for pure alcohol is that the column has been thoroughly cleaned so that the spirit cannot acquire off-flavours from old deposits. Towards the end of the distillation process the alcohol content drops despite its being very pure, so if one wants 95% alcohol this should be kept separate. If this alcohol is to be diluted to normal strength spirit one should filter it through activated carbon to remove any small traces of impurities that may remain.

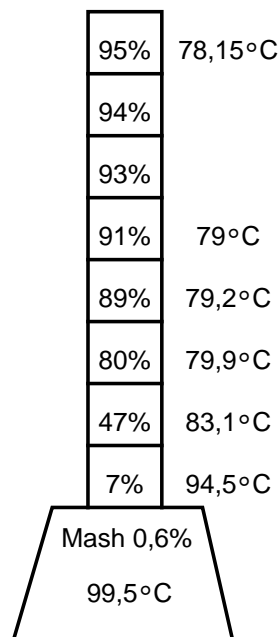

Fractional distillation

The slower one distills the mash, the purer the alcohol will be. To obtain as pure spirit as possible one should use a still with a distillation column. A column is a vertical tube that extends 590 mm or more from the boiling vessel. The column is usually filled with an unsymmetrical filling with as large a surface area as possible. The vapour passes up through the column until it is cool down to a liquid alcohol. Boiling takes place all the way up the column. Because of the differing boiling points of water and alcohol a separation of these occurs in the column and which is termed fractionization. The temperature at the base of the column becomes the same as that of the boiling vessel (towards that of water, 100°C) and the temperature at the top is regulated by the heat source to 78°C. Passing from the bottom to the top the temperature drops off all the way up. So the mash (water) with a higher boiling point condenses and runs back down into the boiling vessel, whereas the alcohol gets through without condensing. One can further improve the column by fitting 2-3 thin tubes through it, through which cold water is passes through. The tubes cool down the column filling, and by this through-cooling, water and fusel oil are separated extremely effectively by faster condensation on the cooled filling. By regulating the speed of the cooling water one can

regulate the temperature in the top of the column. With more powerful cooling (increased water flow) the temperature cools and lowering the cooling effect raises the temperature. This means that one is independent of a stepless heater for the still. One sets the heat source roughly, and adjusts with precision using the amount of cooling water running through the column. The taller the column the more effective is the fractionalisation. But for home distilling only a 590 mm (2 foot) long column is needed. A longer column only fractionally improves the results, but one needs considerably more heat for the vapour to make it through the column. One distillation with a distillation apparatus provided with a column corresponds to eight ordinary distillations. After the column is located a condensation cooler where the alcohol is condensed to liquid form.

Distillation gives best results with the distillation temperature set 1 to 2 tenths of a degree under boiling point. The boiling point of alcohol is 78.319°C is the temperature that produces the best distillate. 95% alcohol has a boiling point of 78.15°C.

If one uses a boiling plate connected directly to a power source for the distillation apparatus, one can, with advantage, use a stepless power regulator (triac) between the socket and the boiling plate. This gives a "volume control" of the heat, and the boiling plate can be set on maximum. During the initial heating up stage, the regulator should not be used. It should be connected when the column has become hot about 150 mm above the still.

If one only has recourse to limited cooling water and a low heat the apparatus will be affected quite easily by such factors as draughts (drafts), when opening doors, etc. If this should occur, increase the heat and water supply slightly so that the distillation becomes more stable at the same head temperature. Distillation apparatus should be located in a draught-free place. The first drops of distillate to emerge (fore shots) are primarily comprised of acetaldehyde. Acetal is also present, a product very similar to acetaldehyde. So-called aromatics are also present. They are not toxic but taste will be considerably improved if they are discarded.

When we have finished the distillation process, the apparatus

should be allowed to cool and the mash should be emptied down the lavatory (toilet). Hot mash has an foul smell. If the apparatus is allowed to stand and cool one must never block the outlet for the distillate. It is easy to get a kink in the tube from which the distillate emerges. If this outlet is blocked, during cooling a vacuum is formed in the boiling vessel. This is because the warm air and mash shrink as they cool and takes up considerably less volume. If the boiling vessel is of glass this underpressure will cause it to implode. If it is of stainless steel it will be screwed up like a steel rag. To avoid this the thermometer and the connection between the column and boiling vessel should **ALWAYS** be undone after distillation process to allow air to enter and equalise within the still and the column.

How to distill extra pure alcohol

First distill 20 litres of mash once and dilute the alcohol to 40-50%. Then redistill this alcohol. Throw away the first 4 cl. Lower the temperature so the distillate drops *very* slowly. Put away the first 3-4 dl (head) for redistilling. Collect 2 liters of alcohol approx. 95% when distilling as slow as possible. This will take 15-20 hours. Take away the rest (tail) for redistillation.

Your 2 liters of alcohol will need only a little activated carbon for purification.

If one want to produce alcohol so pure that activated carbon is not needed, this is possible but there is more work (example: some hours equilibrating the column). One can read about this process in "Making Gin & Vodka" by John Stone, www.gin-vodka.com.

Temperature

The slower the distillation, the purer will be the spirit. To achieve maximum quality the temperature of the thermometer on the top of the column should read 78°C ($\pm 0.2^{\circ}\text{C}$). The temperature is regulated by the supply of heat under the distillation vessel and by regulating the flow of the cooling water. Rough adjustments should be made with the heater and fine adjustments with the cooling water flow rate. A correctly adjusted distillation apparatus does not require any attention. The distillate holds to 85% or more. When the spirit is exhausted no more comes out of the apparatus. The temperature falls in the column and the mash condenses and runs back into the boiling vessel. The heat source must not have a thermostat as it is not then possible to set the temperature so the mash surge boils up the column. With elements built into the boiling vessel, the initial rapid heating can be made with several elements and then distilling can be done with one or two heating elements.



← 78°C

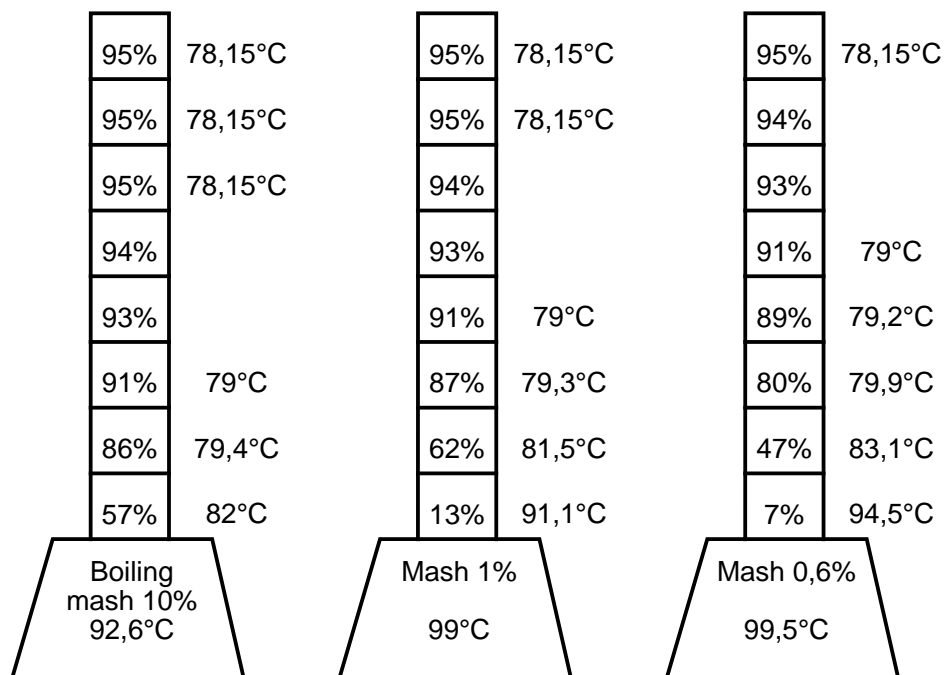

Theoretical thresholds in a distillation column

There are 8 thresholds in the distillation column of a proper home distillation apparatus. Here the thresholds have been simplified for the sake of clarity.

The actual location of the thresholds

In reality there is quite some distance between the two first thresholds and very little between the last. This means that if one only raises the heat a little to move the thresholds up a bit one can drive out the top 6-7 thresholds and get weaker impure spirits. This illustrates the importance of keeping the temperature accurate. If the temperature is held the thresholds are kept in place. That is why it stops dripping from a correctly calculated and accurately adjusted Lab Master still when the alcohol nears exhaustion.

Distillation procedure

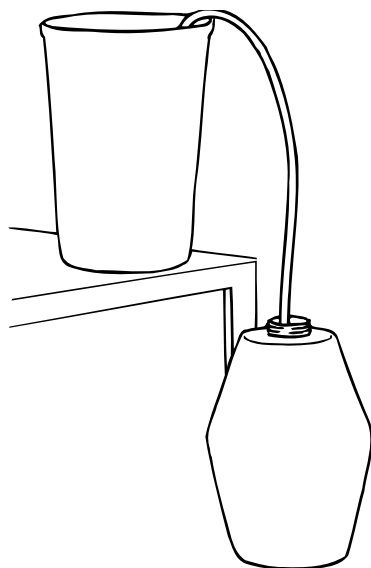

1.

We transfer the crystal clear mash to the boiling vessel using a syphon without disturbing the lees. The boiling vessel must not be filled right up, allow at least 200 mm for boiling. The mash expands when it is heated and spare volume for this is necessary.

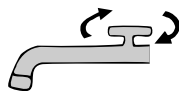

2.

The distilling apparatus should be assembled and the cooling water connected up. The cooling water only needs to run slowly. After 1-3 hours (depending on mash volume and boiling plate capacity) the distillation starts. The first 4 centilitres should be thrown down the drain as they are comprised of by-products (including aldehydes) which are formed during fermentation. These can most accurately be described as scent-like substances and have a boiling point of about 65°C. They are entirely harmless and can be retained, but the flavour will be improved if they are not included.

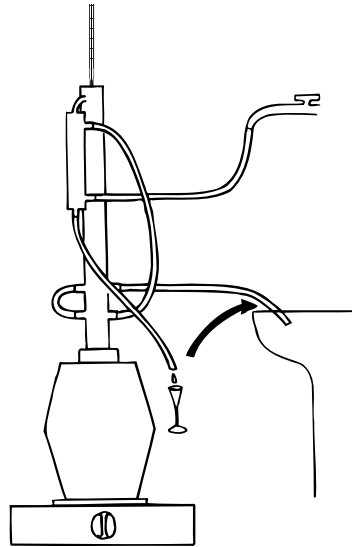
**3.**

Now set the temperature at the column head. This is done by roughly setting the heat source and a fine adjustment of the cooling water. A perfect distillation takes place 1-2 tenths of a degree centigrade under boiling point of alcohol. Try to set 78°C . It is imperative that the temperature is under 80°C .

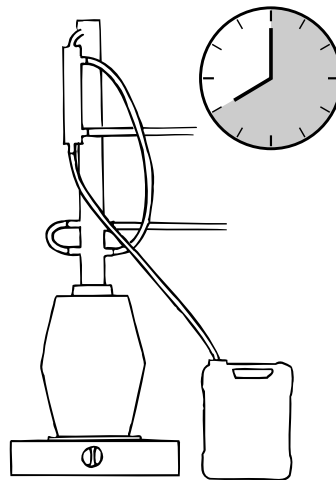
**4.**

After 8-12 hours distillation (or other period of time) it is time to finish the process. Exactly when will be seen by the temperature at the column head. Either the temperature rises, so one switches off at 90°C . The temperature can also drop $10\text{-}20^{\circ}\text{C}$ or more and the spirit stops dripping from the apparatus. This is because one has succeeded in setting the temperature so accurately and with the alcohol all gone from the mash the water cannot get through the

column. From a batch of 22-25 litres of mash, one should be able to produce 2-2 3/4 litres of 90-95%, concentrated alcohol. In practice this means 4-6 litres of 40-45% spirit. Sometimes more with the use of Turbo yeast.

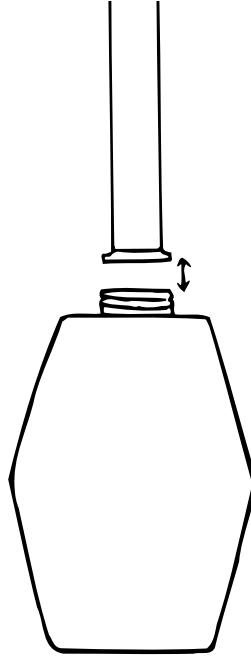

5.

Undo the connector between the column and the boiling vessel and set aside the apparatus to cool. Air *must* be allowed into the vessel, otherwise the resultant vacuum can cause the boiling vessel to implode.



6.

When the mash has cooled pour it out into the lavatory. Rinse out the vessel and reverse rinse the column. Use a detergent when washing the boiling vessel, column and column filling.

SAFETY: Danger of accidents and other important points

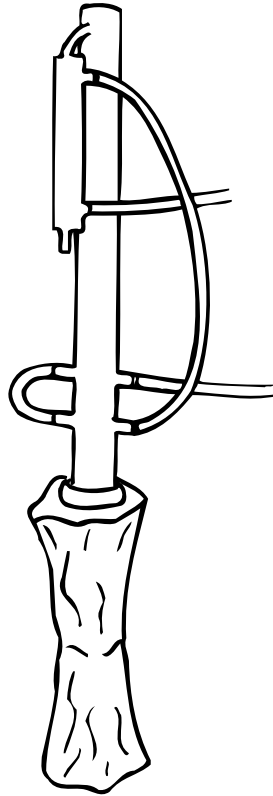

Implosion of the boiling vessel can occur. After distillation the mash cools in the boiling vessel and a vacuum forms. Air cannot get into the vessel through the column in time (the hose can also be twisted) so the boiling vessel shrinks like a rag.

Following completion of the distillation the thermometer shall be disconnected and the connector between the vessel and the column should be undone immediately. This allows the entry of air. The forming of the vacuum begins as soon as the heat is turned off.



Explosions have also occurred. This is nearly always when mixing chemical mash comprising ethyl acetate and sodium hydroxide. Alcohol in gaseous form (the mixture gets hot) spreads into the air. The gas formation is ignited by an open flame or a spark, such as from a thermostat.

Alcohol vapour can leak from a distillation apparatus in a few ways. The column can leak from a welded joint, not be tightly connected, etc., or distillation has started without the cooling water tap being turned on. When one have built a distilling column and/or still, the column should be mounted on the still, and tested by placing under water and connecting a source of compressed air to the outlet of the condensation cooler, to ensure that there are no leakings. If there are any leaks the air will bubble through the water.

If the apparatus leaks, or the cooling hose jumps off, pure alcohol vapour will enter the room when you use the still. Therefore cooling water must be turned on from the beginning, Equipment must be in good condition, and *all hoses fastened with hose clips*. Absolutely no provisional (ad-hoc, short-term, quick & dirty) solutions should be allowed in connecting the cooling hoses to the equipment or the cold water tap. If alcohol vapours do leak the smell will be immediately apparent.



Risk of fire is not relevant as we use electric heating. There have been cases where heating has been speeded up by the use of open flame propane, butane, natural gas or spirit heaters. The first 2 dl of output have been measured off, then the distillation has progressed unattended, with the cooling water on. All has been well until the container has filled up and the alcohol has spilled over and run towards the open flame and ignited. Therefore one only uses electricity and don't smoke either.



Flooding can arise if the cooling water hose jumps off. All cooling water hoses *must* be properly fitted with hose clips. There must also be a proper coupling between the tap and the cooling water hose. The exiting cooling water discharge must be fixed properly, connected or fixed to the sink or a drain.



Poisoning from spirit can never occur. Not even impure spirit is toxic, it just tastes bad because of the fusel oil (which exacerbates any hangover). However, one can drink too much, with known results....

Trouble shooting

Distillation fails to start

Check that the heating is on. Check that the heat source has sufficient capacity and is set fully on. It can take several hours to heat up the mash.

Is there mash in the boiling vessel?

Is there free passage for the steam/distillate through the column, cooler and hose?

Contaminated spirit flows from the apparatus

Too much mash in the boiling vessel. Pour some off.

Spirit comes out but is not clear

The column filling is dirty or home made. Clean or change.

Too much mash in the boiling vessel. Pour some off.

The mash surge boils

There can be a thermostat on the heater. Remove it or change the ring.

The cooling water hose is reversed. Check against the sketch in this book.

Too much mash in the boiling vessel. Allow for at least 200 mm space.

One litre of boiling stones (i.e., Rachi rings) in the bottom of the boiling vessel spreads the heat more evenly and reduces surge boiling. Add some anti foaming agent for example M10 Stabil. If you have a water well and pump, water pressure can vary which can cause surge boiling. There are several solutions to this.

Alcohol is too weak

The temperature is too high in the column. Lower to 78°C.

Too little output

At least 10-13% of the amount of mash should come out, giving alcohol of 84-95%. If less appears it is nearly always because the mash has not been fully fermented. This is usually due to poor Turbo yeast, which can be avoided by only using well-known brands. Always check the mash with the hydrometer before distilling. It should read on the minus scale (coloured field -10 - -20 Oechsle or s.g. 980 - 990). It is meaningless to add more sugar than the yeast can handle.

Dilution



Calculation of the amount of concentrated alcohol required to make up 75 cl of spirits or liqueur to a particular strength

When working with 95% spirit and one wishes to impart a particular strength to the liquor being blended it is calculated in the following way (in this case for a 30% strength):

Volume (litres) x required alcohol strength x 1.05 (1 : 0.95 = conversion of 95% alcohol to 100% alcohol for the purpose of calculation) =

$$0.75 \times 0.30 \times 1.05 = 0.236 \text{ (236 millilitres-use a measuring beaker)}$$

If spirit with another strength is used (for example 80%) then calculate thus: $1 : 0.80 = 1.25$. this gives us the figure that converts the 80% alcohol to 100% alcohol for the purpose of calculation. This method of calculation can be used to work out any strength of alcohol (just a case of changing the % value).

Then: Volume in litres (0.75) x required alcohol % (30) x 1.25 = 281.

281 millilitres of 80% spirits should be used.

When the alcohol content is being reduced one must ensure that there is room for the sugar and essence when blending liqueurs. For example, it is not possible to blend a 40% liqueur using a 45% alcohol as there will be no room for the sugar. If the volume is not made up fully when mixing sugar syrup, essence and alcohol the remainder is filled out with distilled water.

Fusel oil

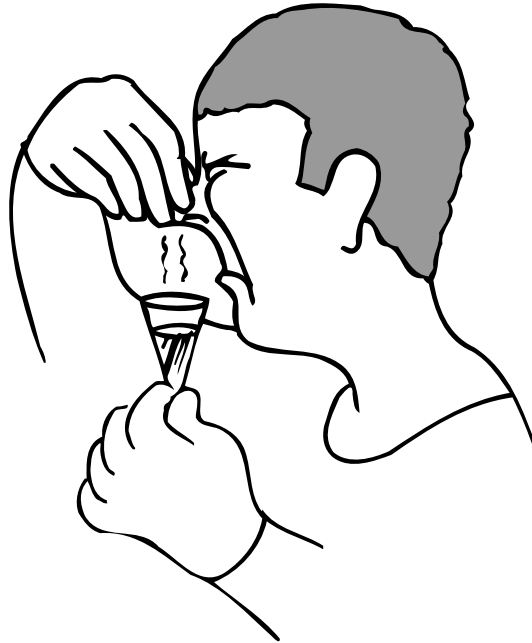

Facts about fusel oil

Fusel oil is the common name for by-products as well as higher alcohols formed in the fermentation process. The principal ingredient of fusel oil is amylalcohol which comprises 65-80% of fusel oil. It comprises all forms of isobutylcarbinol and d-amylalcohol. It also contains 15-25% of isobutyl- and approximately 4-7% of n-propyl alcohol. Amyl-, butyl- and propyl-alcohols comprise the principal components of fusel oils, but there are other substances although none of these is present in significant quantities. They appear in such small amounts that one needs only consider the principal components.

The make up of fusel oil depends principally on the ingredients of the fermentation and the fermentation temperature, and fusel oil is the aroma of the mash. For example, in brandy and other fruit-base spirits (for example, slivovitz, calvados, etc) the fusel oil content is 0.6% or more. This is the principal aroma of the drink and after storage and maturing most of the fusel oil constituents have taken the form of esters.

In basic raw spirit distilled from mash based on sugar the fusel

content is usually between 0.4-0.7% of the 95% alcohol. In an experiment with 200 grammes of sugar in 2 litres of water and using 40 grammes of baker's yeast the fusel content of the raw spirit was 0.40%. As this mash was no more than 6% one must reckon with a little more fusel in practice (despite the overdose of yeast in the experiment).

The addition of ammonium salts to the mash reduces the formation of fusel oil, i.e. yeast nutrient salt (ammonium phosphate).

In total, fusel oil is soluble in water up to 33%. When the raw spirits is diluted down to 40-50% some of the fusel oil goes out of solution and takes on an oily consistency. (The process is facilitated if kept cool). These are the insoluble fusel oils, principally amylalcohols. The separated fusel oil floats up to the surface due to its lower specific weight, where it can be removed by various methods. If the temperature is a maximum of 15°C and circumstances good one can separate 0.3% of the fusel oil (1.5 cl = 15 ml of 5 litres of raw spirits) calculated on concentrated raw spirits. This is over one third of the fusel oil present. Some home distillers usually fill the diluted raw spirits into a bottle right up to the stopper. When the surface has become oily one discards the first millimetre and the rough separation of the fusel oil has been done. Then the results are purified using activated carbon.

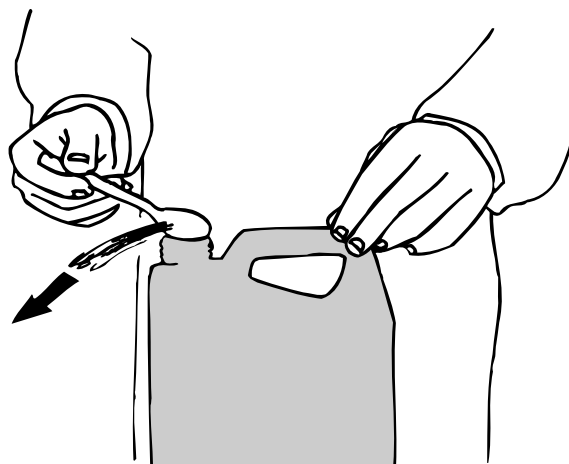

Purification using activated carbon

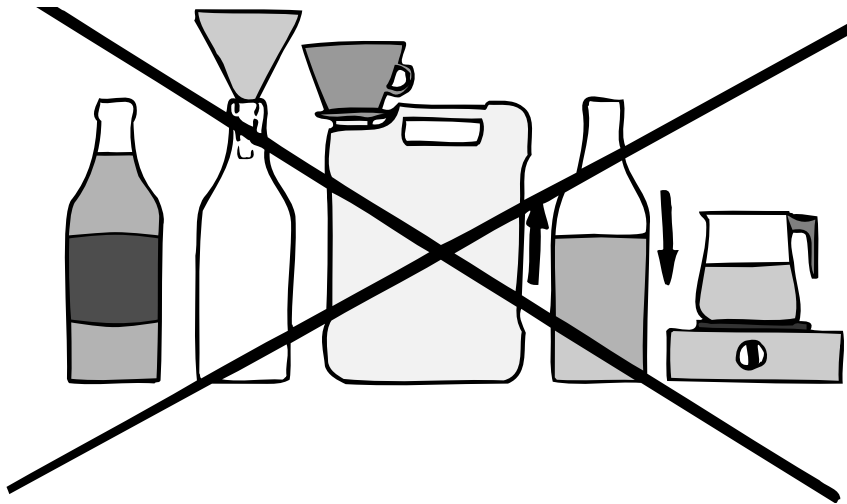

Purification of the spirit is the most important in the entire manufacturing process. It is principally down to purification for the best results. The purification method I describe gives 70% better results than those usually used. *It is the only method that gives an absolutely pure spirit.* If a good activated carbon is used of a small grain size then 2 liters (0,5-1 kg) is sufficient for 4-5 litres of spirit (diluted to under 50%). The same purification method is used around the world. The only difference is that commercial spirits manufacturers filters the spirit from below, percolating upwards for 2.5 meters, with a constant flow rate of the spirit. This is in order to be able to precisely control the filtering at a speed of 0.2 - 0.5 metres per hour.

Activated carbon can be compared to small sponges full of holes. The absorption capacity of the activated carbon is measured in the area of these holes per gramme (expressed in m²/gramme). The grain size of the activated carbon determines how fast it absorbs impurities. Effective activated carbon should have a grain size of a maximum of approx. 1 mm. Larger grains work too ineffectively and are unable to use the surface area inside the grain. Powdered carbon can not be used for the best purification method as the powder consolidates and blocks the process.

The impurities are absorbed by the channels in the activated carbon, including fusel oils and the flavour of yeast. To take best advantage of the channels one filters slowly through a high layer of activated carbon (1.5-2.0 metres).

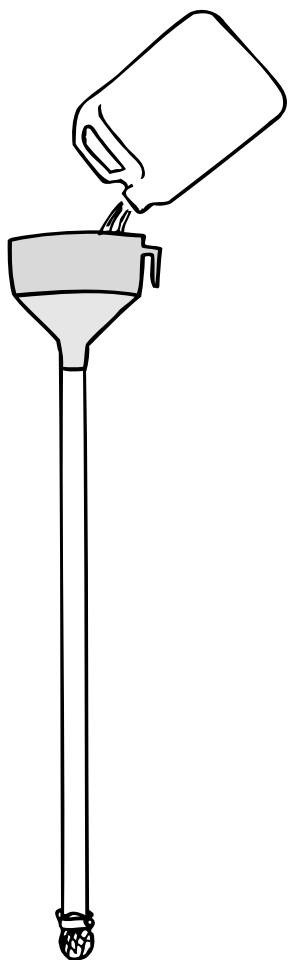

Procedure

Obtain a piece of 40 mm pipe (1 1/2" PVC building grade pipe, a 1 1/2" ABS water pipe, a stainless steel tube, a copper tube for example), with a length of 1.5 metres. Using a stainless steel jubilee clip to close one end with 2 filter papers or 2 linen coffee filters. This end is the base. At the top, place a funnel. The seal between the funnel and the pipe must not leak. The funnel should preferably overlap the pipe. We now have a filter unit. The pipe should be filled with activated carbon through the funnel. The filter paper or linen at the base prevents the carbon from running out. The entire 1.5 metre length of the pipe should be filled. Fill carefully. Some types of activated carbon have such small particles that it cannot be settled very much. If the carbon is settled too tightly the tube will not pass a flow. Normally one can tap the pipe lightly to settle the carbon a tiny amount. If one taps

too much the carbon must be removed and the filling sequence repeated. Usually the pipe remains unblocked with a grain size of 0.25-1 mm or 0.5-1 mm. If larger grain sizes are used the pipe must be tapped a great deal in order to settle the grains as much as possible. Despite this the spirit will almost run straight through without being properly purified (i.e. with grain sizes of 1-3 mm, 3-5 mm etc). If pulverised carbon is used the pipe will be immediately blocked.

Before the spirits are filtered it must be diluted to under 50%. At such lower alcohol concentrations the activated carbon can work much more effectively (with maximum efficiency at approximately 38-42% alcohol) and at the same time we have diluted the impurities to half the original concentration. The spirit should be

diluted with boiled, softened, or preferably distilled water (not distilled water sold for topping up batteries as this is only purified for its intended purpose) to prevent the deposition of calcium in the finished spirit.

Then we filter the spirit through the tube. The procedure takes about one hour per litre of spirit. If a large funnel is used it need only be charged a couple of times and the filtering can look after itself, for example during the night. The pipe will normally manage 4-5 litres of spirit. When the carbon stops functioning as a filter it is soon noticed by the deterioration in the taste and odour of the spirit. If one is not satisfied with the results then re-fill the pipe half full and start again. Activated carbon is relatively cheap so it is better not to be mean with it and use its full capacity to the last drop. Even if there is still some capacity left in the carbon one can discard it without trepidation. Most suitably down the drain.

When one filters spirit through a high layer of activated carbon a peculiar thing happens at the start. Spirit is lighter than water so the first to come out of the pipe is water. You have not been cheated, and the spirit has not been converted into water. It is just a natural physical phenomenon. Very soon afterwards spirit will issue from the pipe.

When all the spirit has been filtered one can pass a litre of water through the funnel. The water will drive out the spirit that remains in the pipe and spirit is collected until water emerges. The gain is quite a few centilitres.

If one want to purificate more then 4-5 liters one can use a tube with a larger diameter, but the same length.

Different brands of activated carbon

There are not so many brands that is suitable for alcohol purification. There is also a big quality difference from one delivery to next, specially on coconut based carbon.

The Brands Chemviron, Suprasorb and Prestige use to have good quality all times and are exported world-wide. I suggest you try those safe cards first and if you want to try other brands you have something to compare with.

Activated carbon filtrate unit

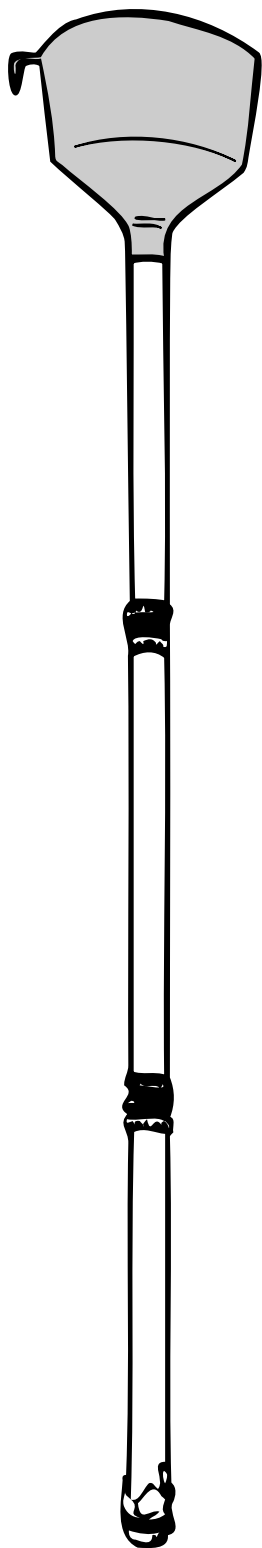

Large funnel

Pipe filled with activated carbon

Height 1.5 metres

Diameter 40 mm

Instructions:

Fill the entire pipe with activated carbon up to the funnel. Double filter paper is fastened with a stainless steel jubilee clip to the base of the pipe to retain the activated carbon. Then it is only necessary to pour through the spirit that is to be filtered. Place a cardboard disc or similar over the funnel to prevent evaporation of the spirit.

Granulated activated carbon is suitable.

Filter paper fixed with stainless steel jubilee clip.

Connoisseurs method

Following filtration in the pipe the same sequence is repeated using new activated carbon. The second charge absorbs very minute traces of impurity (because that is all there is) and is still almost fully effective. Save the carbon for the next filtration. This way you achieve good results without using more activated carbon, as it is only the contents of the first pipe that have been used and discarded. Highly recommended.

Purification several times through the same activated carbon

If one purifies spirit through activated carbon in a pipe and pass the same spirit twice or more through the same pipe the result will be a deterioration.

This is because the pipe method, apart from giving excellent absorption of impurities, has a further function. The impurities are loosely bound to the carbon granules (activated carbon has an affinity charge) most being bound at the top of the pipe and the least at the base. This is one of the reasons why the pipe method (percolation through a thick active carbon layer) is superior to all other activated carbon filtering methods.

So if the same spirit is passed through a second time the loosely bound impurities are pulled down a bit further and some come out with the spirit. Double filtration using the same activated carbon gives inferior results.

Purification must be perfect

Purification must be perfect. Carbon has the capacity to purify the spirit so that it is *entirely* free from off-tastes and bad odours. If the spirit is not perfect it must be purified again. Using the connoisseur method one can purify the spirit by the effective use of activated carbon, without the use of more activated carbon.

Badly purified spirit (off tasting from fusel oil) will from the perspective of flavour conflict with certain essences. If one mixes North Sea Oil (liquorice schnapps, very good with beer) with poor spirit it tastes abominable. This applies to most flavours. However certain flavours such as whisky, dark rum, brandy and bitters can accommodate some off flavours and still taste good.

Blending with essences



There follows some advice on the procedure for getting the best results when blending spirits and liqueurs. The information is taken from a book with manufacturing instructions for spirit manufacturers. The book originates from a leading manufacturer supplying the European liqueur industry.

Basic prerequisites:

- Only use best quality spirit without off flavours.
- Only use neutral softness chlorine-free water which does not contain manganese salts and iron.
- Only the best essences of the highest quality must be used.
- For liqueurs only best absolutely clear sugar syrup made from the finest sugar. The sugar syrup must not suffer from the "boiled sugar taste" and must not have burned. Glucose for liqueurs must be of the highest best-tasting quality.
- At least 6-8 weeks maturation before consumption.
- Whisky must have 10% real whisky added in order to achieve good quality.
- Accuracy and exact attention to detail during blending.

These are the basic prerequisites for a good product. In particular the quality of the spirit and the water for mixing is stressed. Many pages cover water, and in particular the degree of hardness of the water. The different bound and unbound forms of chalk, iron and magnesium salts, which are the principal substances forming the degree of hardness of the water are much more soluble in water than in alcohol. If alcohol is added to hard water the chalk and salts fall out of solution. The fall from solution is faster the greater the higher the alcohol content. The home blender can avoid this problem by the use of distilled water (not battery water) but for the commercial manufacturer it is more economical to use softened well water and then filter through different filters such as activated carbon filters. If a small amount is saved for each litre used this becomes a considerable sum for a years production for a medium or large liqueur manufacturer.

In the case of liqueurs one uses 96% spirit and ready mixed absolutely clear filtered sugar syrup. Granulated sugar contains small particles that can float about in the liqueur one mixes oneself. But it is not more difficult than simply filtering the syrup to remove the particles through a sieve or cloth. Commercial manufacturers filter the product one last time before bottling. For the home blender it can sometimes be an advantage to dissolve the sugar directly in the spirit.

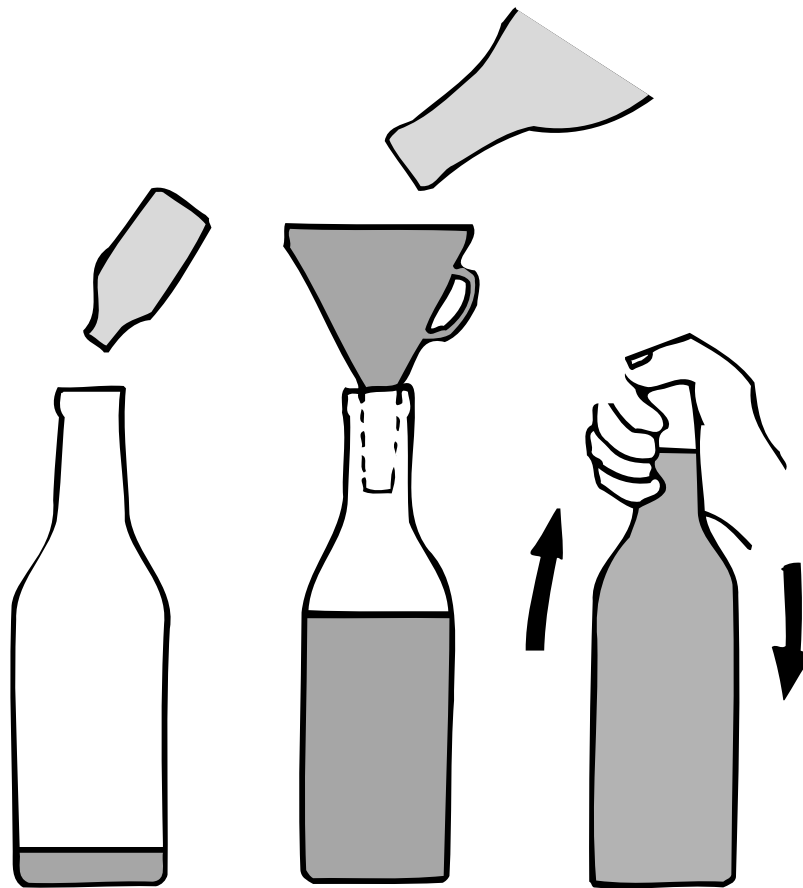

Blending with spirit essences

Pour the essence in an empty bottle and fill three-quarters full with spirit. Shake the bottle. Fill up and shake again. Lay down according to type. Even types that do not require laying down (gin, akvavit, rum, etc.) should be kept overnight, or preferably for some days. Storing improves the flavour of even these types, although the improvement is more marginal.

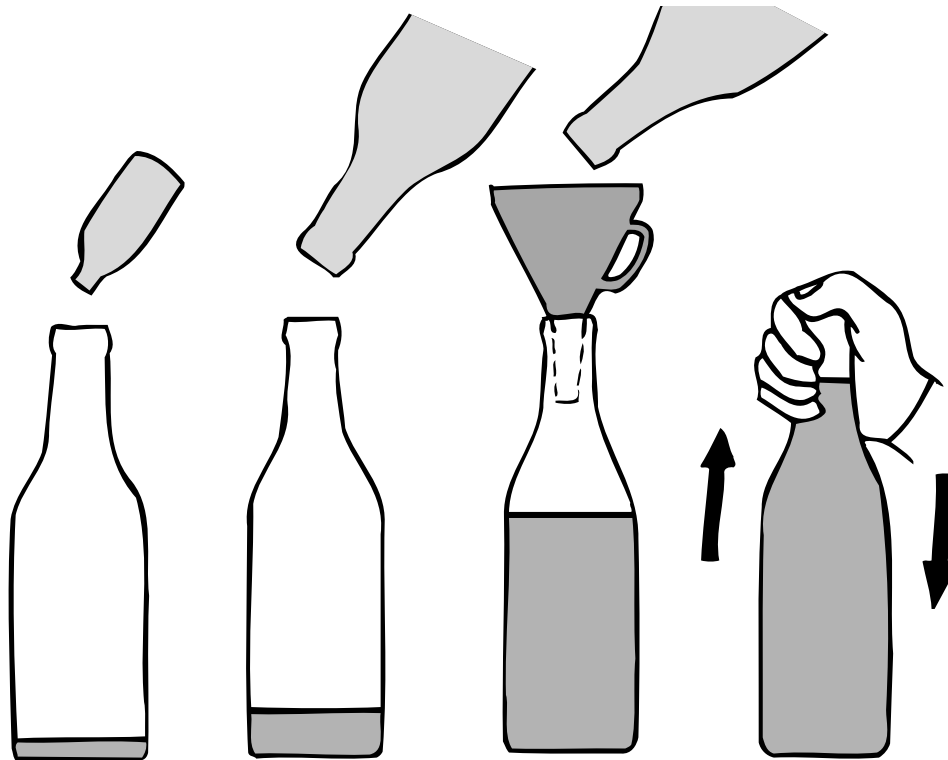

Blending with liqueur essences

Pour essence and sugar in an empty bottle. Fill the bottle three quarters full with spirit and shake until contents are dissolved. Fill up and shake again. Store. No liqueur manufacturer releases stock until it has been matured.

Formula for calculating dilution

How much spirit of a given strength shall be used in order to obtain, for a given volume of liqueur with a lower given strength?

$$\frac{\text{Required alcohol strength} \times \text{volume required}}{\text{Alcoholcontent (\%) of the strong alcohol}} =$$

= how many cl strong alcohol we need

Example: We have spirit at 60% and wish to make a 75 cl liqueur of 25% alcoholcontent:

$$\frac{25 \times 75}{60} = 31$$

We must use 31 cl of spirit.

Begin with the spirit, add the essence, sugar and water. When a volume of 75 cl is reached the required alcoholic strength will be correct.

Table of original alcohol content of liqueurs

Advokaat	Yellow egg liqueur	15%
Apricot brandy	Light brown	29%
Benedictine	Golden brown herbal liqueur	40%
Blackberry Liqueur	Red	27%
Creme De Cacao	Brown	25%
Creme De Cacao	White	25%
Cherry Brandy	Red	25%
Chocomint	Brown	27%
Cointreau	White	40%
Cordial MÇdoc	Red fruit liqueur	38%
Creme De Bananas	Light yellow	29%
Creme De Cassis	Dark Red	24%
Curacao	Brown	40%
Curacao	Green	34%
Curacao	Orange	32%
Cusenier Orange	Light brown	40%
Drambuie	Whisky liqueur	40%
Grand Marnier Jaune	Light golden	38%
Grand Marnier Rouge	Red brown	38%
Green Chartreuse	Herbal liqueur	55%
Yellow Chartreuse	Herbal liqueur	40%
Coffee Liqueur	Brown	26%
Kahlua	Brown coffee	26%
Kaptenlojtnant	Swedish liqueur	40%
Kloster Likor	Swedish liqueur	43%
Lakka	Finnish cloudberry liqueur	28%
Licor 43	Golden herbal liqueur	43%
Mandarin	Orange	25%
Marachino	White cherry liqueur	32%
Parfait l'Amour	Violet	29%
Pernod	Liquorice	31%
Slivovitz	Plum brandy	30%

Original gravity of liqueurs

Peppermint	White or green	30%
Peter Heering	Cherry brandy	24%
Poire William	Pear brandy	30%
Polar	Red	29%
Royal triple sec	White Curacao	39%
Seve fournier	Light brown	38%
Strega	Yellow	40%
Tia Maria	Brown	31%

Original gravity of aperitifs and bitters

Underberg		49%
Angostura Bitters		45%
Fernet Branca		40%
Campani		21%
Ouzo	Liquorice	40%
Rikard	Liquorice	31%

The alcohol strengths given above are based on the strength of the products as sold in Sweden. Local tax laws, excise duty, etc, can affect the alcohol content for a particular market.

Legislation

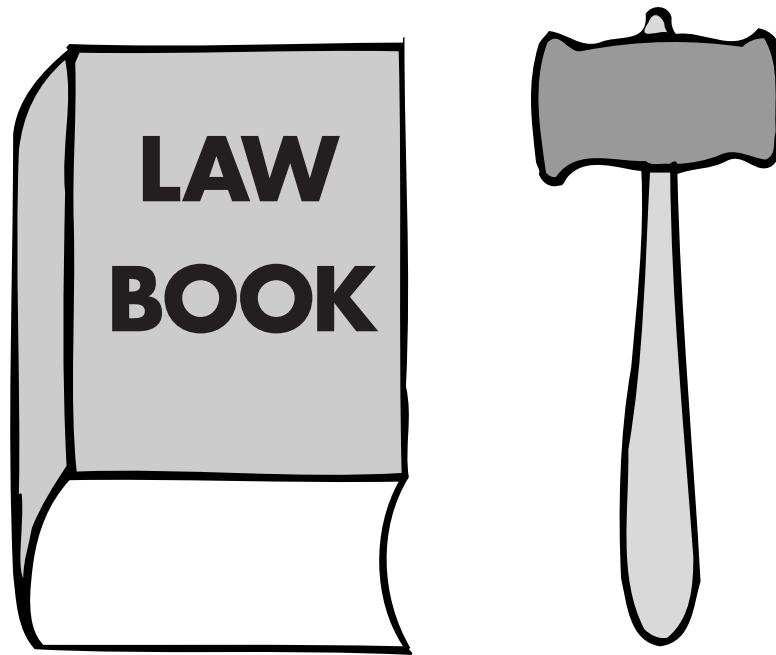

Freedom of the press

This book is permitted to be read and sold in democratic countries with freedom of the press.

Once again it must be pointed out that the contents of this book do not comprise an invitation to put into practice anything that is unlawful in the country of the reader. The reader is urged to follow the current laws that apply where he or she lives.

It is obvious

It should be obvious that this book is not a dare nor a challenge to the reader to engage in distillation of spirits if it is considered a unlawful offense by the legal administration in which he or she resides in. Surely there is no one who seriously believes that?

Home distillation is a current topic of discussion in many countries, and such knowledge is a light burden. This book imparts knowledge that makes intelligent discussion even more pleasant.



Punishment

In countries where it is unlawful to read this book, to make spirits or to own distillation apparatus, the above can happen if one breaks the law.

Is the law wrong in your country?

If amateur distillation for your own use is prohibited in your country, and in your opinion this is wrong, tell your politicians. Mail them, phone them, write to newspapers, make a homepage. Work democratically. But do not break the law. Try to change it instead.

