

RECREATIONAL  
DRUGS

A diamond-shaped collage of various recreational drugs, including pills, capsules, and tablets in different colors and shapes, arranged in a diamond pattern. The collage is centered and surrounded by the text 'RECREATIONAL' at the top and 'DRUGS' at the bottom.

**Professor Buzz**

# TABLE OF CONTENTS

Preface.....	1
Safety.....	4
Equipment, Technique and Reagents.....	7
Crystallization.....	10
Chromatography.....	15
Distillation.....	18
Reductions.....	30
Amphetamines.....	40
Hallucinogens .....	53
THCs.....	70
Analgesics .....	85
Hypnotics, Sedatives And Tranquilizers.....	98
Buying Precursors.....	107
Making Precursors .....	115
The Work Area.....	131
Additional Information Sources.....	137
Abbreviations.....	138
Chemical Sources Nationwide.....	140
Glossary.....	142
Understanding The Periodic Table.....	145
Miscellaneous Tables.....	147

# PREFACE

Congratulations. You have just purchased the most complete and informative book on recreational drug manufacture available. It is based upon a great deal of experience and a tremendous amount of research. I have used easy to understand terms to aid in comprehension of the formulas given and in the theory involved. I have patterned this book after what would appear to be a college textbook or a college accredited correspondence course in illicit drug manufacturing. Please follow carefully my instructions and advice on safety, purification, and referred to reading.

If you have any questions about even seemingly trivial details, then ask someone that knows. Call a college professor, an analytical laboratory, or one of the chemical consulting firms that exist in metropolitan areas. Aldrich Chemical Co. has a toll free number (1-800-558-9160) that enables you to ask the chemist on duty questions concerning what you may need to order from them and what cheaper analogs you may be able to substitute in the formula that you are interested in. Something that may appear to be insignificant may turn out to be the difference between completing or failing a formula and this chemist on duty gets paid to answer any questions you may have. Do not be afraid to ask them (many other chemical suppliers have this type of service also), but do not be a total idiot in doing this. Use common sense, read up on your subject thoroughly and then you will sound like a legitimate operation, not a clandestine drug lab. You will also be able to understand this person instead of having his educated talk go in one ear and out the other. Try not to let them realize what you're making, if possible, find another use for the chemicals or reaction that is not illegal and tell them that is what you're doing. Never give a real name or address, if possible.

Always put safety and caution before time, ease, and expense. If these formulas can be carried out by taking short cuts or by using cheaper reagents, then the scientists who invent them will explain how to do them this way. I have a total hatred towards underground chemists who rush out impure, improperly made drugs with unclean, half-assed equipment. These people are not chemists at all and deserve to go to prison. If I heard of someone running this type of operation I would turn them into the police personally. They take the fun out of recreational drugs and replace it with danger. I do not intend this book to be used for making drugs, but maybe the chemists who are producing drugs will use this material to make better, healthier drugs.

Most drugs are made from or with highly toxic or poisonous chemicals, if used improperly they can cause disease, cancer, or immediate death. Even the most simple of chemical reactions are not to be taken lightly or unprofessionally. Go to a college or some other type of professional laboratory and ask if they will show you around; seven times out of ten they will give you a tour. Look over their equipment; notice the cleanliness of even the floor. Look at the chemists themselves; see how serious and professional they act. This is how your laboratory should look.

As I said above, I do not want to have this book used for the illicit manufacture of drugs, but if you are going to, or have been making drugs, then I have accomplished everything if I have taught you how to make them right. Many analogs of some drugs can be legal to produce, but this does not mean that you can skimp on purification or other important operations described in the formulas. I do not approve of "kitchen crank" or other high speed, slipshod operations. This is how drugs get much of their bad reputation. If drugs were not illegal, we could buy them from major pharmaceutical manufacturers and eliminate much of the bad dope that is being abused today. Unfortunately, we have given up many of our rights over the years, due to ignorant, hypocritical assholes in positions of power, and we are forced to make these drugs ourselves. So we must act as though we are the major pharmaceutical manufacturers and we need to force ourselves to abide by the same rigid rules that the Food and Drug Administration imposes upon them. Besides, the recreational drug abusers are paying good money, they deserve good drugs, after all they're only trying to have a good time.

Laboratories, like any other investment, require a certain amount of capital to start and operate. Spend the necessary cash to buy the proper equipment to do the procedures required. Faulty equipment (not to mention insufficient knowledge) can cause fires, explosions, asphyxiation, and many other hazards. You can have one hell of a nice laboratory for the price of a funeral these days. Also hospitals are in excess of \$150 a day if you are not in intensive care or requiring special services. \$150 a day can operate even the most elaborate of laboratories. Therefore, if you have to beg, borrow, or steal to obtain a functional laboratory, then do so. Is three to five thousand dollars too much to spend on a lab that can easily produce a quarter of a million dollars worth of THC every week? It takes money to make money, but very few, if any, investments can pay off as well as an underground laboratory run by competent chemists.

Although this book is written in easy to understand language and the formulas have been greatly simplified, they should not be attempted by the chemically incompetent. The chemically incompetent are those who never took, passed or remember freshman college level chemistry. I suppose that if you were an A student in high school chemistry, you may be smart enough to understand what you're doing with these formulas. If you do not fall into these categories, then stop reading this book right now. You have no business in an organic laboratory.

Most of the organic compounds listed in this book are highly flammable and have irritating, toxic, and/or poisonous vapors. Many of the reactions in the following formulas are potentially violent and if performed improperly will become violent. If people understand why atoms and molecules behave the way they do under all conditions, they will know how much reagents to use, how fast to add the reagents, what kinds of poisonous byproducts may be formed and what dangers are involved. It is not enough for me to tell you that heating this and that, then reducing it makes a drug. This is unprofessional and dangerous. I want you to understand *why* you do what is required of you to complete a given formula, and a basic knowledge of chemistry is a definite prerequisite. If you forgot, or never knew the meaning of enthalpy, chemical bonding (ionic, polar, non-polar, bond energies), elemental and molecular properties, proton donating, dynamic equilibrium, entropy, reaction mechanism, orbital, phase, redox, pH, photon, rate of reaction, atomic mass, reduction, etc., etc., then you must put down this book and read one or more of the following references until you completely understand what is going on while you are performing these or any other formulas or reactions:

*NEW ORGANIC CHEMISTRY*, by H.L. Keys

*PRACTICAL ORGANIC CHEMISTRY*, by Vogel

*ORGANIC CHEMISTRY*, by Butler & Berlin  
*PRINCIPLES OF ORGANIC CHEMISTRY*, by Geissman  
*C.R.C. HANDBOOK OF LABORATORY SAFETY*  
*BASIC PRINCIPLES OF ORGANIC CHEMISTRY*, by Roberts & Caserio  
*PRINCIPLES OF MEDICINAL CHEMISTRY*, by Foye

This is a short list. Hundreds of good chemistry books are available at any library or book store. It should only take a week or two to read and the importance of this cannot be overstressed. Try to find one that has questions at the end of each chapter, so you can see if you can answer the questions. If you can, great, go on to the next chapter; if not, read it again, Reading is nothing without understanding.

These books will teach you how to solve and balance chemical equations, find molecular weights, how to double or triple the scale of your formula (multiplying the given formula by two or three rarely works as rates of reaction and dynamic equilibrium change much more differently as the mass of reagents and precursors are increased) and other necessary information. I would like to have included this information but it would take several decades to do so and the finished book would be longer than four holy bibles combined. With so many good chemistry books available, it would be impractical for me to do this.

Most of you will not heed my advice to read some chemistry literature until after you waste \$800 worth of chemicals on one small mistake or maybe it will take a laboratory explosion to explain how important some simple chemistry book can be.

# SAFETY

Before commencing any procedures in organic chemistry, you must become familiar with the safety, hazards, apparatus and methods described here in this book and in the referred reading. Those of you who think "I don't need to learn all this preliminary bullshit, because the formula is in easy to understand language" are wrong — dead wrong.

It is true I have reworded the formulas so that the average high school student can understand and complete the operation easily. However, I do not have time to warn the unknowing and incompetent every time a potential hazard is encountered, as most every chemical has dangerous properties. Ethyl ether, as an example, has more BTU's than dynamite and is much more easily ignited. I will not waste time or paper to describe the properties or dangers of every chemical encountered in every formula. It is the duty of any chemist, amateur or professional, to learn these properties. Know what you're dealing with at all times, under all conditions. I have taken much time compiling a superb glossary of most every chemical, operation and apparatus encountered in this book. If you find something I have not listed in the glossary, or if you use a formula not listed in this book, do *not* assume it to be unimportant. Look it up in the *Merck Index* and remember its properties.

Anyone who has been asphyxiated or even seen some large third degree burns caused by chemicals or heat, will be able to relate to the rigid safety measures I will impose on you in this chapter.

## FORES

A small fire extinguisher is cheap and very effective. It should be purchased and located in an accessible position before any chemistry is undertaken. I have known underground chemists that thought it more important to spend \$40 on a glass flask than to spend that same \$40 on a simple little fire extinguisher. One such chemist experienced a small fire that escalated into a massive inferno, destroying hundreds of dollars worth of glassware, chemicals, books and thousands of dollars of property. A small fire extinguisher would have stopped the small fire before it became out of control, even for the local fire department. Also, all fire calls must be investigated by the fire marshall, who would undoubtedly call the authorities when discovering that the cause of the fire was a drug laboratory. The result, an easy bust.

Other fire prevention items include:

1. *A fire blanket.* This is useful for tossing onto table tops and floor fires. Even more important, it can be used to wrap around yourself or a helper who has caught fire. These blankets can be made easily and cheaply by going to fabric or upholstery stores and purchasing a generous

length of non-flammable material. It must be thick enough to keep air from passing through it. Ask the sales person what types of material are flame resistant and how much they cost. You should also ask how much they charge to sew an apron for you, as they are extremely protective in acid spills, fires, explosions, etc. It should be known that some chemicals (i.e. tetranitromethane, nitromethane, concentrated hydrogen peroxide, etc.) are very strong oxidizers, allowing them to burn vigorously without oxygen. So, not only can they be used in a monopropellant rocket motor, they can make fires that are difficult to put out and they may explode violently when exposed to impurities or the wrong chemicals, metals, etc. That's right, folks, no spark or flame necessary for combustion. If you should use a chemical labeled "oxidizer" be extra careful with storage and handling.

2. *Sand bucket.* Flammable liquids tend to spread out when spilled, and when spread out these liquids give off much more volatile, flammable fumes increasing the hazard of fire greatly. If confronted with this type of fire, resist the urge to fight these flames with water, as this will just make the fire bigger by adding more volume to the liquid under the flames. As with any fire, remain cool and collected, quickly go over to the five gallon bucket full of sand (that you conveniently stashed by your work bench) and toss heaps of sand directly onto the fire and its fuel. If the fire still burns after most of the liquid has been soaked up, smother the flames with your blanket or give them a quick burst with your extinguisher. Extinguishers sometimes have so much pressure that they blow and spatter the fire all over the place before putting it out, so when large quantities of flammable liquids are spilled and burning, use sand first, it makes clean-up easier.
3. *Fire extinguishers.* Never use a carbon tetrachloride extinguisher, as these cause phosgene formations. Always use a CO<sub>2</sub> (carbon dioxide) extinguisher. A box of baking soda can be used to smother small fires. Fires inside a flask or beaker can be smothered by covering the mouth of the container with a nonflammable item, i.e., a glass plate.

If your clothes are on fire do *not* run. I know this sounds stupid, but the faster you move the faster and hotter your clothes burn. Walk to your fire blanket or a nearby shower. If you were too stupid to get a blanket and there is no nearby shower, try rolling on the floor and dumping sand or baking soda on yourself. If you have received a severe burn, do not touch or anoint it with anything, get medical attention at once.

Two important rules that are to be observed without exception are:

1. Eye protection must be worn at all times. Safety goggles are the ultimate; safety glasses with side shields are acceptable; prescription glasses are better than nothing, but should be worn with goggles; hard and soft contact lenses are useless.
2. Never work without someone near enough to hear a cry for help. This person should make visual checks on you frequently to make sure you are not gassed or asphyxiated.

Here are a few minor rules to practice:

1. Never taste any compound until the formula requires you to do so. Drug testing should be tried on animals first.
2. When smelling a chemical or compound, never inhale, sniff from a fair distance.
3. Avoid contact of chemicals with your skin. Playtex type gloves are cheap and effective. If contact occurs, wash immediately.
4. Never heat any flask or apparatus that is not open to the atmosphere (have an outlet for pressure to escape) unless properly equipped (see reductions chapter).

5. Use water bath, steam bath, heating mantle, or hot plate when heating or distilling volatile, inflammable solvents (inflammable means BOOM!). Never use a bunsen burner and turn off all pilot lights.
6. Never smoke in the lab. Vapors collect and hang around long after escaping from bottles and flasks.

What to do if you are burned by:

- a. *Acids*. Wash immediately with lots of cold water, then with diluted sodium bicarbonate (2 or 3 tablespoons of baking soda in one cup of water). Rinse again with water and seek medical attention if irritation persists.
- b. *Alkalis, bases*. Wash in turn with water and vinegar. Diluted acetic acid may be used in place of vinegar. If the burn is severe or irritating, see a doctor.
- c. *Bromine*. Same procedure as acid burn.
- d. *Phenol and like substances*. Remove with a solvent that is not very toxic (ethanol or methanol). Then rinse with very diluted bromine solution (one teaspoon per quart of water) in glycerol.
- e. *Phosphorus*. Wash immediately with sodium carbonate solution followed by warm 1% copper sulphate, then remove any copper coated phosphorus with forceps and/or gently running water.

Let's say you thought that goggles were a waste of time and a real pain in the ass. So you took them off, or never even purchased them. Now you experience caustic spurting (very common), or maybe the stopper blows out of your flask and you have reagents in your eyes. Chances are two to one that you are now permanently blind.

What to do if reagents get in your eyes:

- a. *Acids*. Wash with running water or wash bottle, clean water from beaker, or anything with clean water, and do it fast. Follow with diluted (1 to 2% sodium bicarbonate to 98% water) baking soda solution. Then drop several drops of castor oil into eye(s).
- b. *Alkalis*. Wash with water, then with dilute boric acid solution, then a drop of oil.
- c. *Glass shards in eye*. Unless this is easily removed with forceps, do not attempt to dislodge; hold eye open, no blinking (yes, this takes great will power) and absolutely no rubbing until a doctor can remove fragment(s).

In case of asphyxiation, remove victim to fresh air first, and remove restrictive clothing around neck and chest. Perform artificial respiration and send for doctor. If gassed while working alone, you will pass out and continue to be gassed until death.



# EQUIPMENT, TECHNIQUE, AND REAGENTS

*Glassware.* A typical set of glassware with standard taper ground joints like those shown in Figure 1.1 would be employed in an undergrad course. The joints permit you to assemble apparatus quickly and securely, but they must also be greased carefully (do not let the vaseline squeeze down into reaction vessel), and they are acceptable only with joints that have the same exact taper. Never use 24/40 joints with 19/22 or 14/20 or vice versa. Never use ground glass joints with formulas requiring diazomethane; clear seal joints are available at a small extra charge. Never perform a reaction without greasing glass ground joints.

Rubber stoppers may be used if you cannot afford ground glass jointed glassware. Rubber stoppers may be used in conjunction with ground glass joints. Make sure your rubber stoppers fit properly and lightly grease inside and outside with vaseline. Bore holes in stoppers carefully and size them to fit apparatus snug.

Cork stoppers can react with or contaminate certain chemicals and should not be used.

Other glassware necessary are as follows:

*Erlenmeyerflasks and beakers.* These are fairly expensive and may be replaced with heat proof pitchers found on coffee makers. Corning and several other companies make many different types of heat proof glassware that can be picked up at yard sales dirt cheap and used effectively in the laboratory. Remember, even the best glass can be broken by a rapid change in temperature. Separatory and addition (dropping) funnels are sometimes the same piece used in either role. In some reactions they are a must. They have a valve at one end and can be stoppered at the other end and the entire funnel, even the valve, is made of glass.

*Filtration and pouring funnels.* These should be glass or stainless steel unless working with very "mild" compounds, e.g.,  $H_2O$ ; then plastic and aluminum are acceptable. Buchner funnels and their substitute will be discussed under filtration in the methods chapter.

*Graduated cylinders.* These are necessary and inexpensive. You should have a small size for measuring small amounts accurately (25 ml) and a large size for measuring large quantities rapidly (250 ml).

*Capillary tubes.* These are made from glass pipets by heating a pipet or glass tubing and pulling them in two when the glass has reached a workable temperature. These items are inexpensive and practice makes perfect.

*Thermometers.* A high quality thermometer is only about \$8. It is best to purchase two — one for high temps and the other for low temps. Make certain it is for measuring degrees in centigrade as this is what all formulas require, unless specified differently. Candy, meat and other types of thermometers will not fit your apparatus, are not accurate enough for most reactions and are unacceptable.

*Stirring.* Stirring is usually unnecessary in reactions that require boiling as the turbulence of boiling is sufficient. In other reactions a stirring device shown in Figure 1.1 cannot be beat. If the reaction can be carried out in a beaker, then an eggbeater can be used if set up exactly as shown on the work bench diagram. Variable speed eggbeater type mixers are powerful, fast, cheap, plentiful and with a little ingenuity can easily be adapted to any stirring device, but they must be housed in a vapor proof box and must be mounted securely. Low amperage, sparkless, stirring motors can be bought from an electrical repair shop dirt cheap. Make sure they are sparkless or mount them inside a vapor box, like the eggbeater. Every lab should have at least two mixing devices, in case one mixer breaks or in case two different compounds need to be stirred at the same time. Low amperage motors should be available for those formulas that require long periods of stirring. Magnetic stirring devices can be bought or built, but I feel they are weak, troublesome, expensive and inferior to a good mechanical setup.

*Heating.* There are three different sources for heating and your lab should have all three.

*Bunsen burners.* These are of very limited use, as most reactions require flammable substances. Their purpose is mainly for gkss work, generating and super heating steam (see work bench diagram for safe usage).

*Steam heat.* It is very easy to produce and can be used safely for so many things: steam distillations, steam cleaning, creating a vacuum, etc. No lab should be without it. Make sure that steam does not get into anhydrous or dry reactions.

*Electric heating elements.* These should also be available in your lab. They are sometimes the only heating device capable of producing higher temperatures.

*Heating mantles.* These are state of the art devices and are worth the cost. Show the plans from the work bench diagrams to someone electrically inclined. A good electrician can make you one of these in a matter of minutes and he should have all the parts laying around his shop. He should charge just a fraction of the price of a heating mantle. (*Note:* Make sure he knows that the element he made will be exposed to flammable vapors.)

*Heating plates.* Even if you have a good heating mantle you should get a heating plate. These are made from electric fry pans if done as shown. If you are unsure of what wire to use, ask someone who knows. Fry pans are usually good for developing 400°F (205°C). This is sufficient for most distillations, refluxing, and drying.

## JOINTWARE

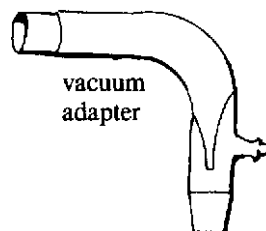
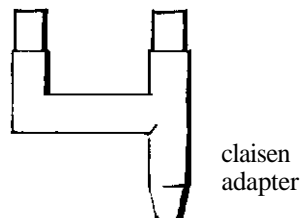
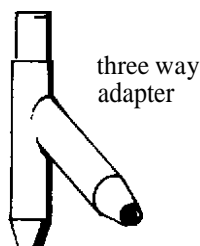
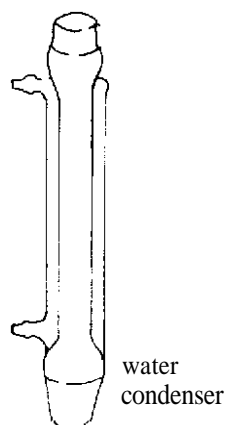

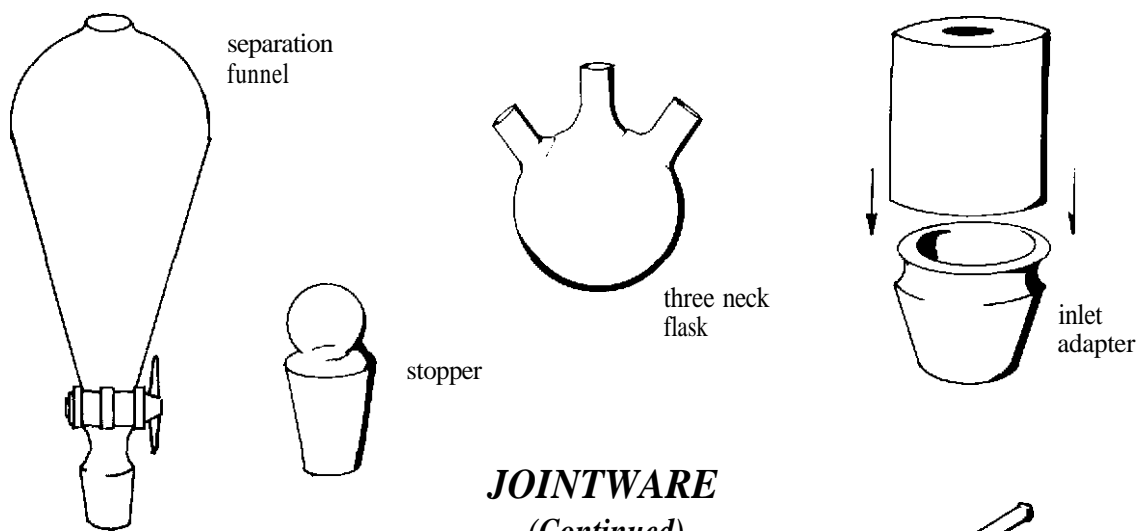

**JOINTWARE**  
(Continued)

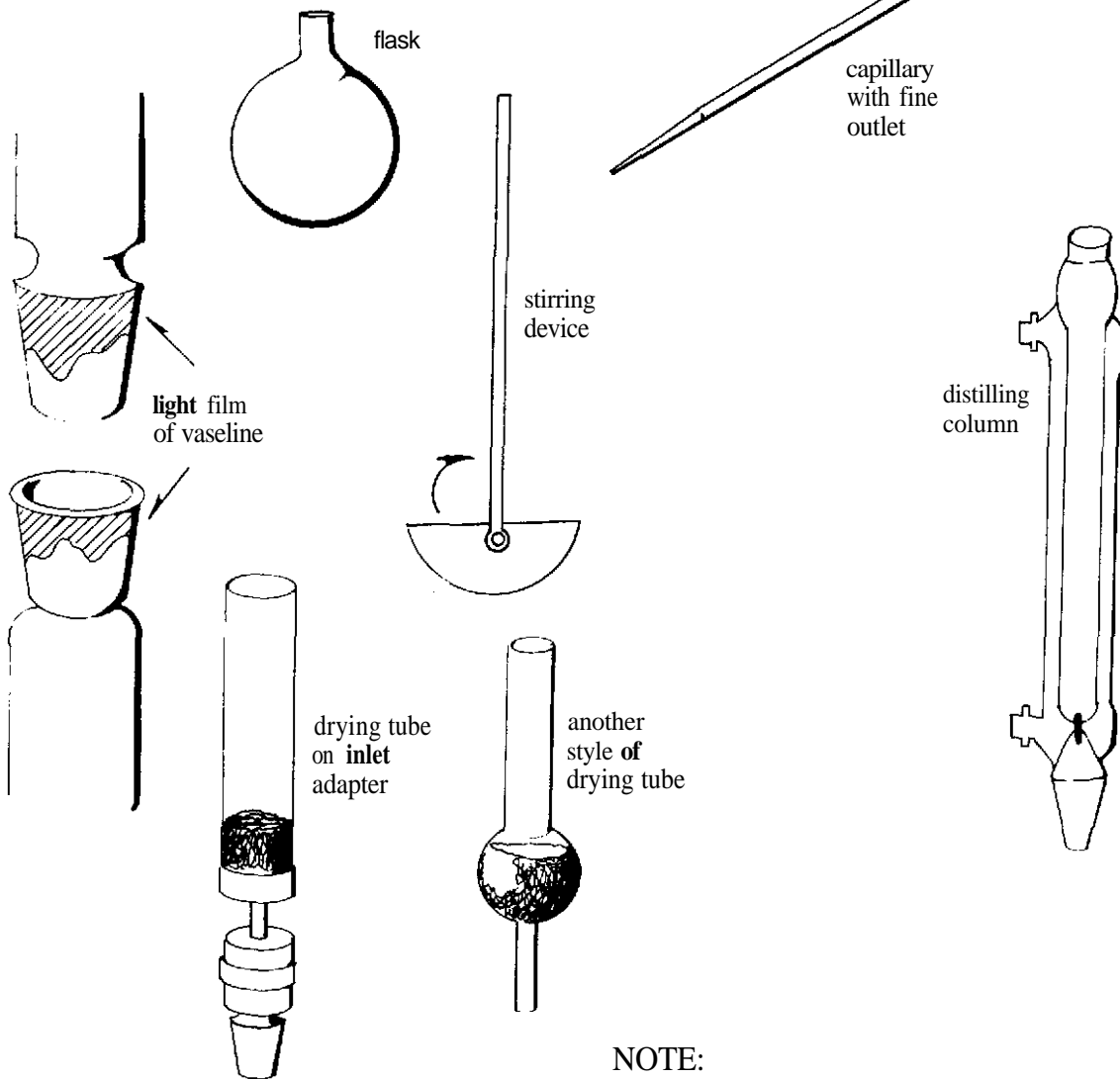

NOTE:  
These are *not* scale drawings.

# CRYSTALLIZATION

The solid product is seldom pure when obtained from a chemical reaction, being contaminated with various impurities, reagents and byproducts. For purification, the process of crystallization, sometimes called recrystallization, is generally employed. When dealing with large quantity formulas, the utmost care should be taken to obtain the maximum yield of a pure crystallized compound.

*Crystallization by Cooling.* The ideal solvent is one in which the compound to be obtained in pure crystalline form is insoluble at cold temperatures, but readily soluble at hot temperatures. Also the impurities should either be insoluble or else very soluble and filtered accordingly to remove. In real life operations, this perfect solvent cannot always be found, so the nearest approach to it should be selected.

The solvents most commonly employed are: water, ethyl and methyl alcohol, ether, benzene, petroleum ether, acetone, glacial acetic acid; also two or three solvents may be mixed to get the desired effect as described later. If you still cannot dissolve the compound, try some of these: chloroform, carbon disulfide, carbon tetrachloride, ethyl acetate, pyridine, hydrochloric acid, sulfuric acid (acids are usually diluted first), nitrobenzene, aniline, phenol, dioxan, ethylene dichloride, di, tri, tetrachloroethylene, tetrachloroethane, dichloroethyl ether, cyclohexane, cyclohexanol, tetralin, decalin, triacetin, ethylene glycol and its esters and ethers, butyl alcohol, diacetone alcohol, ethyl lactate, isopropyl ether, etc.

If unsure of what solvent to use, look in the *Merck Index* or in a chemistry handbook. This may save you the time and expense of testing for the best solvent.

*Choosing a Solvent.* In order to select a suitable solvent, place small quantities, (50 to 100 mg) of product into several test tubes and treat with a few drops of single solvents of the above class. If the product dissolves easily in the cold upon shaking or if it does not dissolve appreciably on boiling, the solvent in question may be regarded as unsuitable. Where the product or substance dissolves on heating or boiling, and separates out again on cooling, the solvent used is suitable; make sure that you choose the solvent that gives good crystals in the greatest abundance. At times, crystallization will not take place due to cooling or even supercooling; in such a case, the side of the glass container should be rubbed with a glass rod, and/or "seeded" by the addition of a very small amount of crude product, since such operations often induce crystallization. With substances which are sparingly soluble in the common solvents, solvents of high boiling points such as toluene, nitrobenzene, etc., should be used.

Where no single solvent is found suitable, a mixture of two mixable solvents, one of which the product is soluble and the other insoluble, may be used. The substance is dissolved in a small quantity of the solvent that has the strongest dissolving power, then the solvent that does not dissolve the product, is added until complete crystallization occurs. This process can be carried

out with or without heat. Let me use an example. You just dissolved a few grams of nitrostyrene in a small (always use a small amount of solvent if possible) quantity of boiling ethanol and upon cooling in a freezer no crystals appear. Next, you try "seeding" and another hour in the freezer, but still no luck. By testing small amounts of the styrene with different solvents you find something that will not dissolve it, so you add this solvent slowly to the hot or cold styrene solution and the product crystallizes, if not you must now take much time to evaporate both solvents. Needless to say that this does little purification and may take days. Evaporation is greatly speeded up if done under vacuum conditions.

*To Prepare Solutions.* If considerable heating is necessary, a reflux condenser should be employed to avoid loss of solvent. Where the resulting solution does not require filtration, a conical flask should always be used. During any heating, the contents of the vessel needs to be frequently shaken or stirred, since the crystals melt to a heavy oil settling on the bottom of the vessel making the vessel liable to crack.

In preparing the solution, an excessive amount need not be employed at first; successive small quantities should be added to the boiling or near boiling solution until the substance just completely dissolves, or until nothing but impurities remain undissolved. With substances of low melting point, care should be taken that concentrated solutions from which the substance commences to separate at temperatures above its melting point are not used,

*Crystallization by Evaporation.* This method is employed when the substance is so easily soluble in all solvents (hot or cold), that it will only crystallize after, partial or complete evaporation. If complete evaporation must be employed, impurities will remain. So, if possible, filter off the mother liquor (solvent), as this is where the dissolved impurities will be. If you should need to heat the product with an effective solvent until thoroughly dissolved, pour through filter paper to remove solid impurities.

The type of vessel employed depends on volatility of the solvent; obviously the conical flask already recommended for "crystallization by cooling" is not suitable for spontaneous evaporation, while a beaker or shallow dish is. When the latter type of vessel is used, "crusts" often form on the sides above the surface of the liquid. Such crusts seldom consist of pure substance so they should be removed carefully with a spatula or spoon before attempting to filter off the crystals.

Another method that can be used, if the above methods fail, is to dissolve the substance in some solvent, then add a second solvent mixable with the first solvent, but in which the substance is not soluble or sparingly soluble. The first solvent is then gradually removed and the substance crystallizes back out. If the first solvent is more volatile than the second, it can be evaporated out of the solution leaving the non-soluble solvent behind to crystallize the substance. If the first (dissolving) solution is not as volatile as the second solution, place the solution in a desiccator over some substance which absorbs the first solvent but not the second; in this way water may be removed from a water-alcohol solution by caustic potash or quicklime.

If a substance can only be crystallized by total evaporation, it can usually be purified by distillation first.

## ***FILTRATION***

Filtration by means of suction is employed, when possible, as this gives a more rapid and complete separation of mother liquid from substance. Most any funnel can be made to work if

equipped with a platform on which the filter paper can lay. Such a platform can be made from a small ceramic plate with many small holes drilled through it or wire mesh. As long as the platform does not react with your substance, it should be acceptable. Buchner funnels (see Figure 1) come with perforated discs and are inexpensive.

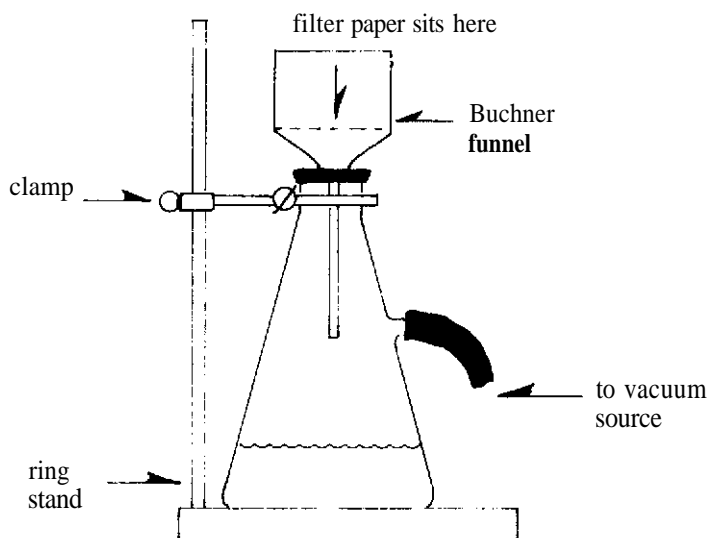

**Figure 1**

Some things to remember during vacuum (suction) filtration are: the funnel tip should be below the vacuum source outlet, cut your filter paper to fit the funnel platform exactly, in other words, do not let the paper rest on the sides of your funnel

*Hot Filtration.* A device such as the one pictured in Figure 3 is easy to make out of tubing and is very effective. It will be required when substances crystallize before passing through the filter paper while filtering out non-soluble impurities.

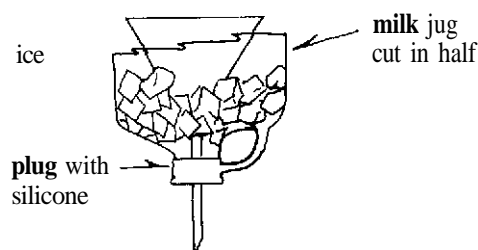

**Figure 2**

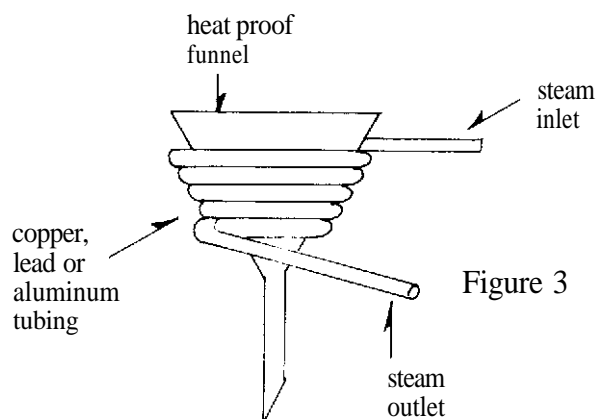

**Figure 3**

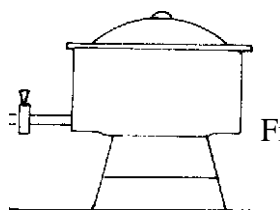

**Figure 4**

**Figures 2, 3, and 4**

*Cold Filtration.* These devices (Figure 2) can be made by cutting a one gallon milk jug in half and sealing the bottom to fit your funnel with silicon, grease your funnel lightly with Crisco or butter so it can be removed after the silicon has set up. For a list of freezing mixtures see cooling section.

### ***PORE SIZES FOR GLASS OR PAPER FILTERS***

BS specified maximum pore diameter of range	principal uses
150 - 250	coarse distribution of gas in liquids
90 - 150	filtration of very coarse precipitates gas distributors in liquids extraction of coarse grain material
40 - 90	medium gas filters mercury filters extraction of medium grain material
15 - 40	fine gas and mercury filters extraction of fine grain material
5 - 15	analytical and preparative work of the finest precipitates
less than 3	bacteriological filtration

*Cooling.* Some formulas call for external cooling of the reaction. These temperatures should be followed exactly or the product intended may evolve into something completely different. To aid you in cooling, I have listed the following substances to be mixed and the temperature reductions created by them. If carried out in an insulated container these mixtures will hold a more even temperature for a much longer period. Those little Playmate lunch boxes make perfect insulated containers.

Mixture of substances in grams	Temp falls from 15° to
250 calcium chloride cryst. + 100 aq.	-8°
8 sodium sulphate + 5 cone. HCl	-12°
25 amm. chloride + 100 ice	-15°
45 amm. nitrate + 100 ice	-17°
50 cone. HCl + 100 ice	-18°
33 sodium chloride + 100 ice	-20°
1 pot. thiocyanate + 1 aq.	-24°
100 dil. H <sub>2</sub> SO <sub>4</sub> 66% + 100 ice	-31°
3 calcium chloride cryst. + 2 ice	-49°
solid CO <sub>2</sub> + ether	-100°

If you do not understand any of the above abbreviations or if you have no idea which of these chemicals are hazardous, then you need to go back and read some type of basic chemistry before attempting these simple cooling mixtures.



# CHROMATOGRAPHY

*Vapor Phase Chromatography.* This is accomplished by constructing or buying complicated and expensive equipment. Although this method is very effective, it is superseded by the simple, inexpensive and effective column chromatography.

*Thin Layer Chromatography.* Thin layer chromatography is primarily a tool for small qualitative analysis (deciding which solvents elute which substances, etc.). A microscopic amount of sample is applied at one end of a small plate covered on one side with a thin absorbent coating. The plate is then dipped into a shallow pool of solvent which rises on the coated layer, permitting the compounds of the sample to move with the solvent to differing heights. The individual components can then be detected as separate spots along the plate. Unfortunately this process can only be scaled up to do several grams at a time, again making column chromatography the champion of chromatography.

If, however, you wish to use thin layer, consult your local library on methods. I chose not to go into depth on thin layer because it is so inferior to column style.

*Column Chromatography.* The main idea here is to dissolve your mixture and put it on the adsorbent, at the top of the column. Then you wash the mixture down the column using at least one eluent (solvent), perhaps more. The compounds of your mixture are carried along by the solvents and washed out of the column at different rates and collected into separate flasks. Why do you want to do this? Let us say you have a substance that needs to be purified, but it cannot be distilled because it decomposes at a low temperature, or you wish to extract one of many mixable liquid substances that have been mixed together, etc. A column chromatography can separate, purify and extract.

*Preparing The Column.* Alumina or silica.gel is supported by glass (see Figure 7) with a valve to control the flow of eluent. Right above this valve place a fritted glass disc or a wad of glass wool or cotton to keep everything from falling out. Do not use too much, and do not pack it too tightly, or too loosely.

Fill the column half full with the least polar eluent that you will use. If your particular formula does not give the eluents to use (this is rare) then you will have to look up the directions on

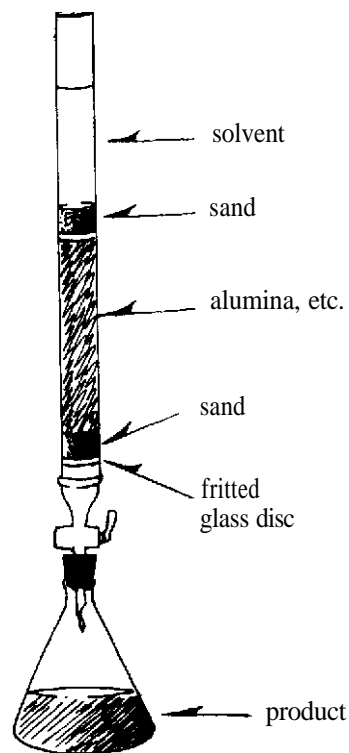

thin layer chromatography or find an effective eluent (remember this is just another name for solvent) through trial and error with this small scale method.

Slowly put sand over the cotton until you have at least one centimeter. Next, very slowly add the adsorbent (alumina, silica). Adsorbents liberate heat, possibly causing the eluent to boil, ruining the column. *Add the adsorbent slowly.* Use about 25 g of adsorbent for every 1 g of mixture you want to separate. When the alumina settles, add another 1 cm of sand to the top. During the entire procedure the level of the eluent *must* be higher than any solid material placed in the column,

Now you may open the valve until there is a little over 1 cm of solvent above the top layer of sand. If there are any cracks or air bubbles in the adsorbent, dump everything and start over.

Dissolve the mixture (your substance) in the same solvent you are going to put through the column, keeping the amount as small as possible (this is called the analyte). You should be using the least polar solvent that will dissolve your substance. Now you may add the analyte very carefully; do not disturb the sand. Open the valve until the level of the column is the same as it was before you added the analyte (1 cm above the sand). At no time let the solvent level drop below the sand! Add the required eluent (solvent) to the column, not disturbing the sand. Open the valve to slowly let the eluent run through the column until the first compound comes out. Collect the different compounds in different flasks. At no time let the solvent drop below the top of the sand! If necessary, stop the flow, add more eluent, and start the flow again.

Should the compounds be colored, you can watch them travel down the column and separate, changing collection flasks as the colors change. If your compound is clear then you will have to use one of the following steps:

1. Occasionally let one or two drops of eluent fall onto a microscope slide. Evaporate the solvent and see if there are any properties of the compound that should be coming through, such as crystal shapes, tastes, smells, viscosities if oil, etc.
2. Occasionally use several drops to spot, develop, and visualize a thin layer chromatography plate. Although thin layer is very similar to column, you should read up on it as I do not have time to go into the complete operation.

If you find the eluents are taking an excessive amount of time to wash down the compounds, then switch to the next most polar solvent. If you had two compounds and one of them is already collected, then go ahead and get some really polar solvent and get that last compound pronto.

**List** of solvents arranged in order of increasing polarity. *Note:* This is a very small list of many solvents.

(Least polar)	petroleum ether
	cyclohexane
	toluene
	chloroform
	acetone
	ethanol
(Most polar)	methanol

## THE REFLUX

This common procedure consists of mixing your reagents with a solvent, boiling the solvent, condensing the vapors, and returning them back to the flask. Observe these rules.

1. The flask should be big enough to hold both the reagents and the solvent without being more than half full.
2. Place the condenser upright on flask and clamp.
3. Adjust your heat source so that the vapors travel no further than halfway up the condenser. Add another condenser if your formula requires a specific temperature and you experience vapor travel higher than halfway at that temperature. Also use drying tube with anhydrous reagents.

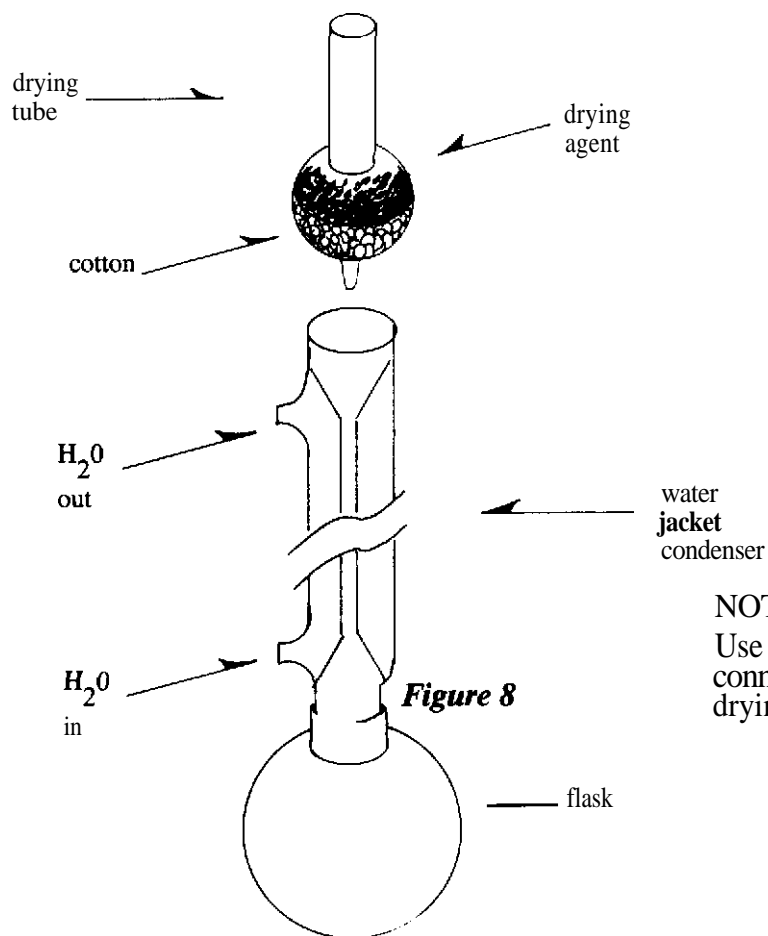

NOTE:  
Use Rubber stopper to  
connect condenser to  
drying tube.

# DISTILLATION

There are four types of distillation processes; find the one that suits your needs and record or memorize the operation.

**Class 1:** *Simple distillation.* Separating liquids that boil below 150°C at one atmosphere (1 atm) from non-volatile impurities or another liquid boiling at least 25°C higher than the first liquid. Note: the liquids to be distilled must be mixable with each other. If they are not then they would form separable layers, which you separate much more easily with a separatory funnel.

**Class 2:** *Vacuum distillation.* Separating liquids that boil above 150°C at 1 atm from non-volatile impurities or another volatile liquid that boils at least 25°C higher than the first liquid. Boiling points can be found in the *Merck Index*.

**Class 3:** *Fractional distillation.* Separating mixable liquid mixtures that boil at less than 25°C from each other at 1 atm.

**Class 4:** *Steam distillations.* Separating or isolating tars, oils, and other liquid compounds insoluble or slightly soluble, in water at all temperatures. These compounds do not have to be liquids at room temperature.

Now that you know which class you need, I will discuss each one in great detail, but remember, you should know how to do a Class 1 distillation before attempting a Class 2, and so forth.

## ***CLASS 1: SIMPLE DISTILLATION RULES***

1. Never use a bunsen burner on compounds that boil below 70°C, or on flammable substances.
2. Make all ground glass joints and or stoppers fit tight and secure.
3. Do not fill the distilling flask more than half full.
4. Always use a boiling stone, but never add a stone to any hot substance or you will wear the hot substance.
5. Place your thermometer bulb just below the vapor outlet. If the thermometer does not have drops of condensation dripping off of the bulb then the reading is not correct.
6. Use plenty of clamps to secure your apparatus tightly.
7. Always allow a way to relieve pressure at the receiving flask end of the setup, or the distilling flask will surely explode.

8. Start your heat slowly until gentle boiling begins and liquid starts to drip into the receiving flask at about ten drops per minute. You may have to increase the heat to keep material coming over.
9. Always keep cold water running through the condenser, in the bottom and out the top (see Figure 12).
10. When temperatures change rapidly or drastically, this usually indicates that the compound coming over has changed also; you should change the receiving flask with a clean empty flask to keep your products separated.

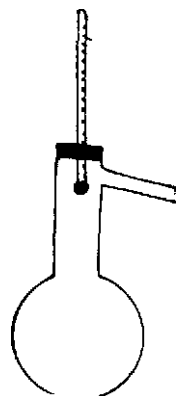

Figure 8W

for low B.P.

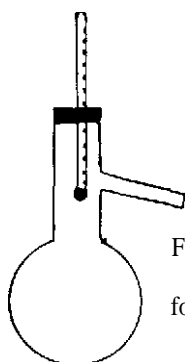

Figure 9

for med. B.P.

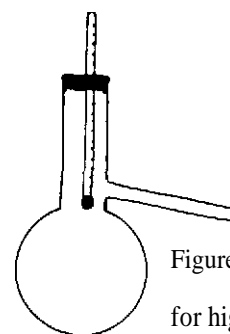

Figure 10

for high B.P.

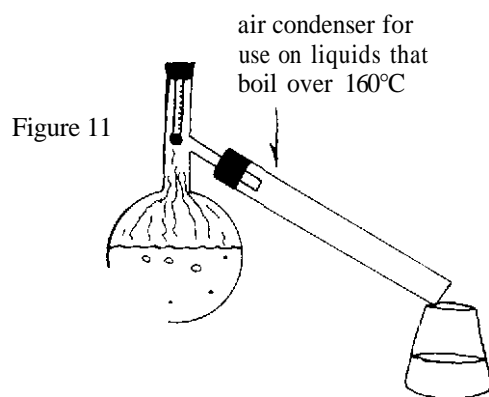

Figure 11

This is for attaching air condenser to vacuum source

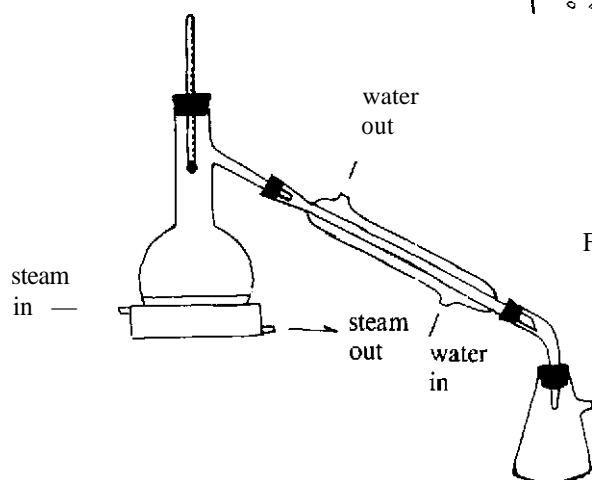

Figure 12

to vacuum source if required —

must be left open if not required

**Figures 8, 9, 10, 11, and 12**

## CLASS 2: VACUUM DISTILLATION RULES

1. Learn all the rules on Class 1 distillation.
2. The thermometer can be replaced with an inlet tube. If your flask has the provisions for both a thermometer and an inlet tube, then by all means also leave the thermometer in the reaction. The inlet tube should always be used to prevent the bad bumping that goes along with vacuum distillations. Boiling stones are useless.
3. Inlet tubes should have capillaries so small that the vacuum is not reduced. An inert gas like nitrogen should be introduced through the inlet tube if the compounds decompose in air.
4. Control of the heating is *very* important! After applying the vacuum, increase the heat very slowly.
5. Apply the vacuum before the heat. Never apply the vacuum to any hot substance. If you can apply enough vacuum to a liquid you can boil it without heat (a fact of physics),
6. During a vacuum distillation, it is not unusual to collect a pure compound over a 10-20° temperature range.
7. Try to keep your vacuum pressures equal. Buy or make a nano-meter to measure reduced pressure (see Figure 13).
8. A Claisen adapter can be added to allow use of both inlet tube and thermometer. If you must decide between the two then pick the inlet tube.

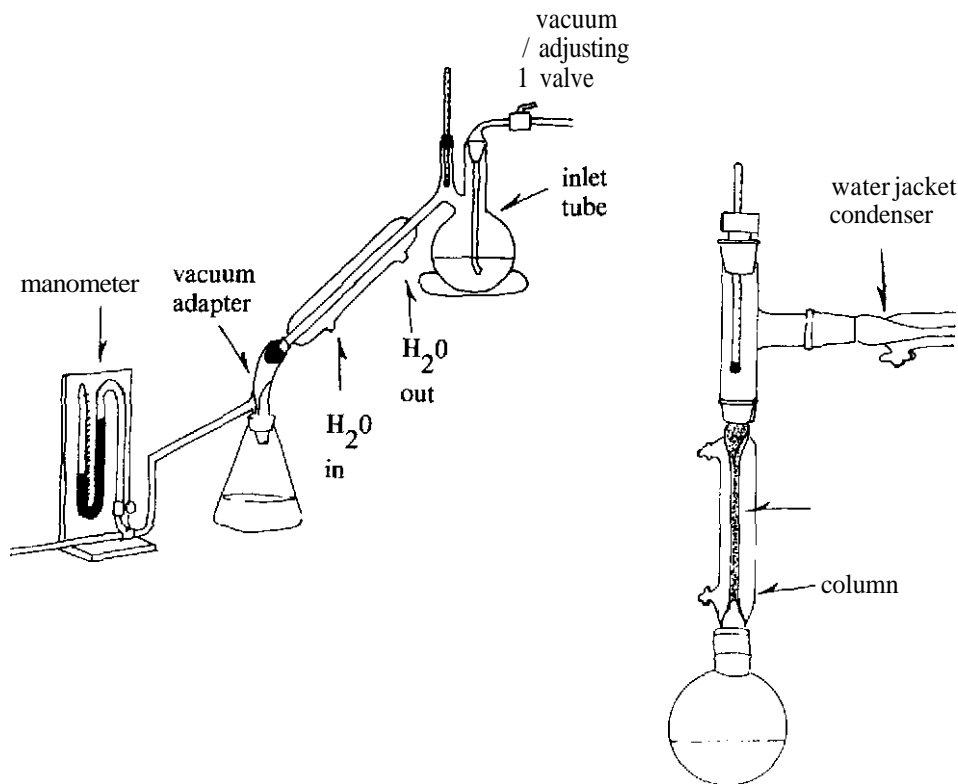

Figure 13 and 14

### **CLASS 3: FRACTIONAL DISTILLATION RULES**

1. Read all the rules on Class 1 distillations.
2. Do not confuse the condenser with the column. The column is wider, and has glass projections at the bottom to hold up the packing (see Figure 14).
3. Do not run water through the column jacket.
4. Occasionally, the column is used without any column packing.
5. Do not break off the projections that support the column packing.
6. If necessary, push a small wad of heavy metal wool (stainless steel, etc.) down to the bottom of the column to support small packing particles. Sometimes this wool is the entire packing.
7. Make sure that the packing will not fall into your distillation flask,
8. Lots of liquid will be held up on your packing, make sure that you have enough compound to start with, or it will all be lost in the packing.
9. Do not distill with too much liquid. Never fill the flask more than three fourths full.
10. For maximum yields, a chaser solvent should be used to push the compound that is left behind in the column on over into the condenser.

#### **Special Note: Azeotropes**

Certain liquids cannot be completely separated even by fractional distillation with the best equipment. These are the dreaded azeotropes, mixtures with a constant boiling point.

One common azeotrope is ethyl alcohol 96% water 4%. This combination can be boiled to dryness at one constant temperature. I cannot go into all the azeotropes you may run into during drug manufacture. So, before you attempt any formula, you must go to a science library and research all of the chemicals, solvents, reagents, etc., that are used in that particular formula and learn what can and cannot be used with what. Look in *Chemical Abstracts*, the *Merck Index*, or one of the many other fine reference books available.

For an example, let's say you want to chase some ethyl alcohol through your column packing. You notice that the boiling point of water is high enough to push or chase the lower boiling ethyl alcohol out of the column. Instead, they formed an azeotrope.

If an azeotrope boils off first, it is a minimum boiling azeotrope. The remaining liquids will not distill until all the azeotrope is gone. If the other liquids come over first, followed by the azeotrope, then you have a maximum boiling azeotrope.

### **CLASS 4: STEAM DISTILLATION RULES**

1. There are two ways of generating steam for this distillation:
  - A. Leading steam directly into the system. This is a little more complicated and requires a water trap to keep excessive water from ruining the distillation (see Figure 15).

Devices To Superheat Steam

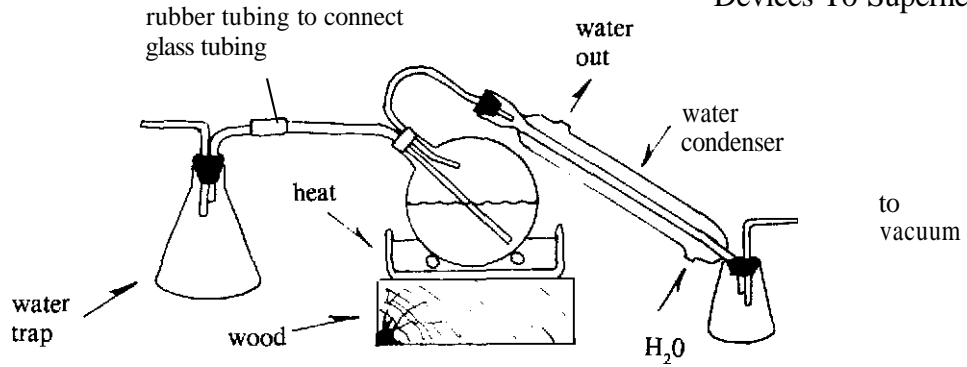

Figure 15

B. Adding hot water to the distillation flask is also a simple way to generate steam also (see Figure 16).

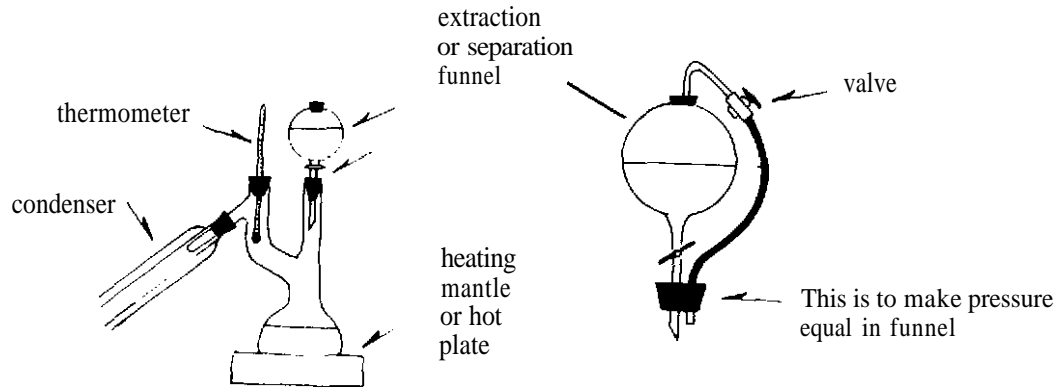

Figure 16

2. Read all the rules on Class 1 distillation.
3. Use at least three times as much water as sample. Do not fill the flask much more than half full.
4. Keep adding more hot water as needed. As the water boils and turns to steam, it leaves the flask, carrying sample.
5. The sample or product is still coming over if you see two layers or cloudy solution in your receiving flask.

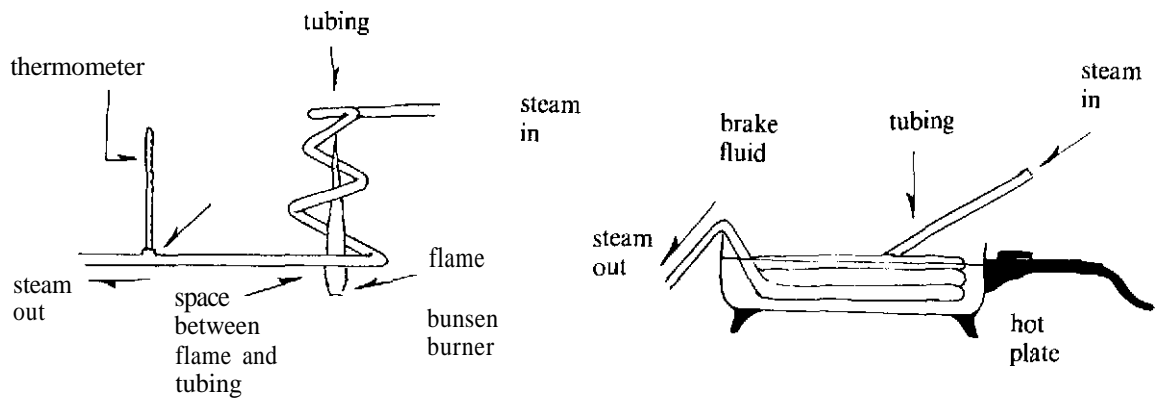

Figure 17 and 18



6. If the solution is clear then you should add a little salt to a small sample of the solution. If two layers form, then you need to keep on distilling.
7. To find out which layer is water or product, add a little water and watch carefully. The water you added will go to the water layer.
8. Do a back extractions with an immiscible solvent to get most of the product from the water layer.

### **THE SOXHLET EXTRACTION**

This apparatus is not totally necessary when called for in a formula, but for the modest price of the apparatus, or the little bit of work with which a homemade unit can be constructed, it is worth carrying out the formula with such a device. Also, yields are improved considerably, sometimes paying for the apparatus with the first formula completed.

The principle is basically the same as any coffee pot; a paper thimble is filled with the substance to be extracted (F) and a loose plug of cotton is placed (E) over the top. The Soxhlet apparatus is attached to a flask containing the proper solvent (if the solvent is not given in the formula, then usually you must find a solvent in that either the desired substance or the impurities are insoluble in). Attach a condenser to the Soxhlet tube (B). The solvent is boiled causing vapor to rise and pass through the holes (C) into the condenser where it is turned back into liquid. The liquid drops down into the thimble and solvent. When the solvent level exceeds the top of the riser tube (D) the solvent overflows back into the boiling flask (G) and the process is recycled or continuous.

You should use a minimum amount of solvent, and if necessary add more through the condenser (do not use too much and do not let the flask (G) become dry at any time). When the extraction is complete, dismantle the apparatus and crystallize the substance from the solution in the flask, or separate the resulting oil, etc.

This is the most efficient way to get myristicin from nutmeg.

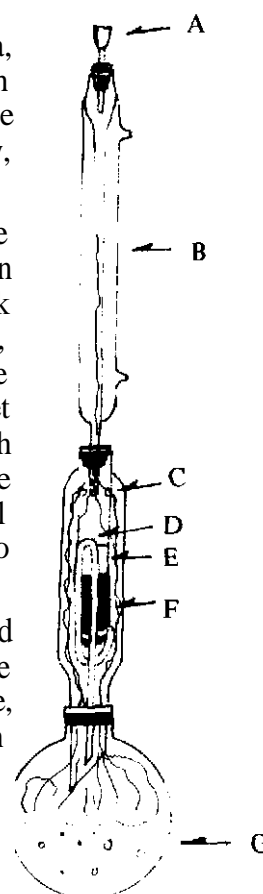

### **EXTRACTING AND WASHING**

Some people find these two important operations complex and confusing, when they are actually quite simple. You extract good substance from impure mixtures. You wash impurities from good material.

*Solid — Liquid Extracting.* This is not done too often, but if you have ever made tea or coffee you should be able to do this, as it is basically the same thing.

*Liquid — Liquid Extracting.* This requires a separatory funnel and two liquids (solutions) that *must* be insoluble in each other. The liquids must form two layers in the funnel or washing or

extracting cannot be performed. Solids (crystals, etc.) need to be dissolved in a solvent, and that solvent must be insoluble in the extracting or washing liquid. Never throw away any layer until you are sure that it does not contain product.

*Using The Funnel.* Add the liquid to be extracted or washed to your funnel; if you forgot to close the valve your liquid is now on your shoes. Add the extractor or washer carefully to the mixture. Install the funnel stopper and invert so that the stem points to the roof; make sure one of your hands is holding the stopper securely inward. Most of these liquids fizz when mixed with the extractor, creating pressures that must be bled off through the valve as follows. Swirl or shake once very gently while still pointing the stem at the roof, then open the valve to bleed or "burp" the pressure. Close the valve and shake twice, then burp the funnel. Keep increasing the shaking between burps until you can shake the living hell out of the mixture for long periods, as this is the type of agitation necessary to extract or wash.

## **DRYING**

Remember the ethyl alcohol — water azeotrope? You might be thinking: If I cannot distill the water out and I want my alcohol anhydrous (dry), because the water will kill my yield, what should I do? You need to dry. Sometimes you will have to dry reagents, sometimes solvents, and sometimes the products themselves.

*Baths.* Baths can dry many solid substances that do not decompose under heat. Some substances can take more heat than others so a thermometer must be used along with the knowledge of how much heat can be safely used without destroying the product, or changing it into a different substance. The types of baths are many: water, air, toluene, sand, oil, and graphite, but they all have the same general rules. Hot plates and heating mantles must follow these rules also.

1. Always protect the substance you are drying from the water in the atmosphere by fitting a drying tube into the glassware that is holding your substance. The drying tube should be filled with a suitable drying agent.
2. If using a liquid, never allow it to boil.
3. Never use excessive heat for drying. I have heard of nitro propene burning faster than gunpowder due to excessive heat. Personally, I feel this could have been caused by a nearby pilot light that was left burning.

Solids can also be dried at room temperature on filter paper or porous tile. You should protect the substance from dirt and dust by covering with filter paper or a funnel. A vacuum desiccator will greatly speed up the drying process, and should be used on products that are destroyed by the small amount of water in the atmosphere. A vacuum desiccator is shown in Figure 4.

*Drying of Liquids.* Liquids are usually dried by filtering through or mixing with a solid dehydrating agent. The most common solid drying agents are: calcium chloride, sodium hydroxide, caustic potash, anhydrous sodium sulphate, anhydrous potassium carbonate, anhydrous cupric sulphate, phosphorus pentoxide, and metallic sodium. Now for the bad news, it is essential that the drying agent have no action on the liquid or any substance that may be in the liquid. Great care should be used in the choice of a drying agent, and much research may be required. If you do not find the necessary information call a chemist or some one who knows. I will mention a few rules.

1. Never use calcium chloride to dry alcohols or amines.
2. Never use caustic potash or caustic soda to dry acids, phenols, esters, certain halides, etc.
3. Always use a very small amount of drying agent, otherwise you will lose product by excessive absorption. It is better to use several small amounts than to use one large excessive amount. A useful agent called Blue Drierite can be mixed with the cheaper White Drierite and visually inspected to determine if its absorbing powers are used up. Blue Drierite turns pink when it has no more absorbent power. If you use Blue Drierite directly, you take a chance of contaminating your product with a cobalt, as it was made for use in drying tubes (see Figure 8).
4. To dry a moist solid it is often convenient to dissolve it in ether and dry this ethereal solution with the proper drying agent. Evaporate to retrieve the solid.

### MELTING POINTS

Melting points are important for determining the purity of solid products. A small amount of sample is packed into the closed end of a capillary tube with a wire or small glass rod. It is then attached to a thermometer, keeping the sample next to the bulb as shown (see Figure 19). Next submerge into oil filled tube, keeping setup in the middle of tube (do not touch the sides or bottom). Watch for temperature at which solid sample melts.

### REAGENTS

I cannot give you directions to prepare every possible strength of every known reagent, but I can give you enough examples to figure out how to prepare any percentage or strength you might need to prepare. No matter what you are making, the rules below are to be followed.

1. Only the purest chemicals should be used unless another grade is specifically recommended.
2. Analytical (extremely accurate) balances should be used for weighing chemicals.
3. When measuring liquids, use a class A volumetric pipette unless otherwise specified.
4. Do not pipette strong acids or alkalis by mouth. Use a rubber bulb or an adjustable vacuum source.
5. Hot and cold liquids should be allowed to come to room temperature before measurement.
6. Only distilled or deionized water is to be used.
7. Mix thoroughly after dilution.
8. Light sensitive reagents are to be stored out of the light.

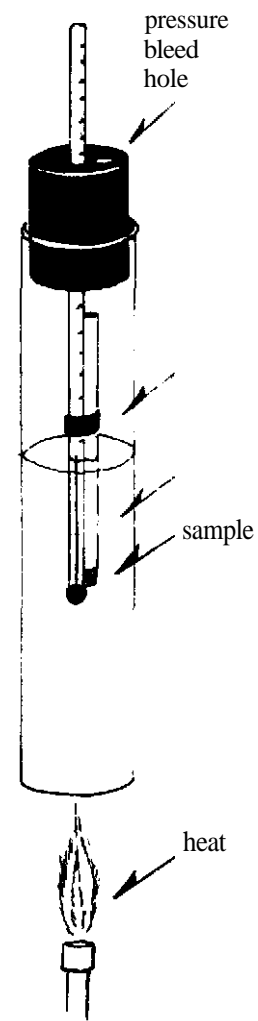

Figure 19

*ACETIC ACID 1.0%*

Pipette 1 ml of glacial acetic acid into a 100 ml volumetric flask. Dilute to volume with water and mix.

*ACETIC ACID 10%*

Measure 100 ml of glacial acetic acid and transfer to a 1 L volumetric flask containing about 600 ml of water. Mix, dilute to volume with water and mix again.

*ACETIC ACID 50%*

Add 50 ml of glacial acetic acid to 50 ml of water and mix.

*A CETONE-ALCOHOL MIXTURE*

Mix 500 ml reagent grade acetone with 500 ml of 95% ethyl alcohol.

*ACETONE-ETHER MIXTURE*

Mix 200 ml of reagent grade ether with 100 ml of reagent grade acetone.

*AMMONIUM HYDROXIDE, DILUTE (0.5%)*

Transfer 2 ml of concentrated (28%) ammonium hydroxide to a flask and add 98 ml of water. Keep no longer than 1 month.

*AMMONIUM HYDROXIDE 5%*

Mix 20 ml of ammonium hydroxide (this is concentrated, 28%) with 80 ml of water. Store in a glass stoppered bottle.

*AMMONIUM HYDROXIDE 10%*

Mix 36 ml of cone, ammonium hydroxide with 74 ml of water.

*CALCIUM CHLORIDE 2.5%*

Weigh 2.5 g of calcium chloride, and transfer to a 100 ml flask. Dissolve and dilute to volume with water and mix.

*CALCIUM CHLORIDE 10%*

Weigh 10 g of calcium chloride, and transfer to a 100 ml flask. Dissolve and dilute to volume with water and mix.

*HYDROCHLORIC ACID 0.05 N*

Place 900 ml of water in a 1 L flask and add 4.2 ml of cone, hydrochloric acid. Dilute to volume (1000 ml) and mix well.

*HYDROCHLORIC ACID 0.25 N*

Place 500 ml of water in a 1 L volumetric flask. Carefully measure 21 ml of cone, hydrochloric acid in a 25 ml graduated cylinder and add to the flask. Rinse the cylinder with water and add the washings to the flask. Mix, dilute to volume and mix again. Add 0.5 ml of Brij 35 and mix thoroughly.

*HYDROCHLORIC ACID 1 N*

Add 8.4 ml of cone, hydrochloric acid to a volumetric flask containing 70 ml of water. Dilute to volume and mix.

*HYDROCHLORIC ACID 2 N*

Add 167 ml of hydrochloric acid to a volumetric flask containing 600 ml of water. Dilute to volume and mix.

*HYDROCHLORIC ACID 6 N*

Slowly and while mixing add 500 ml of cone, hydrochloric acid to 500 ml of water and mix well.

*HYDROCHLORIC ACID 5%*

Dilute 5 ml of the acid in 95 ml of water and mix.

*POTASSIUM HYDROXIDE 1.25 N*

Add 70 g of potassium hydroxide to a volumetric flask containing 600 ml of water. Mix to dissolve and cool to room temperature. Dilute to volume with water and mix well.

*POTASSIUM HYDROXIDE 33%*

Add 330 g of potassium hydroxide to a 1 L volumetric flask containing 300 ml of water. Cool, dilute to volume and mix.

*SODIUM CHLORIDE, SA TURA TED*

Add 40 g of sodium chloride to 100 ml of hot water and mix.

*SODIUM HYDROXIDE 0.0075 N*

Add 7.5 ml of 1 N sodium hydroxide to a volumetric flask containing 800 ml of water. Mix, dilute to volume, and mix again.

*SODIUM HYDROXIDE 0.01N*

Put 1 ml of 1 N sodium hydroxide into a 100 ml volumetric flask and dilute to volume with water and mix.

*SODIUM HYDROXIDE 0.05 N*

Prepare from a concentrated solution of sodium hydroxide that has been standardized,  $\text{ml} \times \text{N} = \text{ml} \times \text{N}$ . Standardize this dilute solution against a standard acid solution and adjust to 0.05 N if necessary.

*SODIUM HYDROXIDE. IN*

Put 100 ml of 1 N sodium hydroxide into a 1 L volumetric flask and dilute to volume with water and mix.

*SODIUM HYDROXIDE 0.4 N*

This may be prepared from a concentrated solution of sodium hydroxide that has been standardized. Or: Weigh 16 g of sodium hydroxide pellets and transfer to a 1 L volumetric flask. Dissolve and dilute to volume with water and mix well.

*SODIUM HYDROXIDE 1 N*

Prepare from a concentrated solution of sodium hydroxide that has been standardized. Standardize the diluted solution against 1 N acid. Adjust to 1 N, if necessary.

*SODIUM HYDROXIDE 2.5 N (10%)*

Dilute solutions should be prepared by using a nearly saturated solution that has been standardized. If the normality of the concentrated solution is known, then the volume needed to make a dilute solution may be determined with the following formula:

$$\text{ml} \times \text{N} - \text{ml} \times \text{N}$$

Or: 10% (2.5 N) can be done as follows

Weigh 100 g of sodium hydroxide pellets and transfer to a 1 L volumetric flask containing 800 ml of water. Mix to dissolve, cool to room temperature, dilute to volume and mix.

*SODIUM HYDROXIDE 40%*

Weigh 40 g of sodium hydroxide pellets and transfer to a pyrex 100 ml volumetric flask containing 50 ml of water. Swirl or mix to dissolve. Cool to room temperature, dilute to volume and mix again.

As you should have noticed, percentages are easy to figure out how much reagent to mix with your water. With the formula above and standardized solutions you can also figure the strength in N measurement quite easily.

### **CHEMISTRY HINTS**

1. Before beginning any preparation, read carefully the entire method and also obtain a clear idea of the theory as well as the entire practice of the operation. Know the reason for every step in the process.
2. Read any other references that can be found on the entire process, or even better, read references on the individual steps.
3. Work on a definite plan, never omitting anything for the sake of speed, cost or ease. These formulas are designed by experts with decades of schooling. They do everything for good reason; if a step was unnecessary, they would not take the time to do it.
4. Procure suitable and sufficient apparatus. This applies especially to the use of vessels appropriate to the quantities to be used.
5. Clean thoroughly and, if necessary, dry all apparatus before use. (If a formula calls for any dry or anhydrous chemicals, solvents, reagents, etc., then even the humidity in the air should be kept out of the reaction.) Scrub stubborn residue with acetone and a bristle brush, then use soapy water, and rinse thoroughly with water.
6. Fit apparatus together carefully and compactly, paying particular attention to the clamping that holds the apparatus steady and to the fitting and boring of corks and stoppers.
7. Adhere to the instructions given with regard to definite times, temperature and weights.
8. Develop a habit of observation; notice all changes and remember or record them. This may later tell you what you are doing wrong if the reaction fails.
9. Take and test samples whenever advised or convenient to do so.
10. Remember that the criterion of practical work is the yield of pure substance obtained, and if this differs by more than 10% from the yield stated, seek the cause of this difference, and then repeat the process.
11. Test a sample of the product's properties and characteristics (melting point, boiling point, weight). Cocaine and most of the other drugs will have specific tests that should be performed also to determine purity and potency.
12. Cost of the preparation (see apparatus section). Do get a good idea on the cost of a particular formula, make a list of chemicals and apparatus necessary, then call a supply company (see suppliers section) and get prices of the items. As a general rule, don't start something you cannot afford to finish.
13. Keep bench and work area clean and uncluttered. When you are finished using a chemical, put it back into storage and even if you are not finished with it, seal it back up with the cap or stopper. A clean work place makes things much faster, easier and safer.
14. *Special Note:* Never, under any circumstances attempt to make any drug using any of the formulas from this book. Find the reference given in a library and copy the said formula from the Journal only by a copy machine. The publisher and myself are human and may have made

an error in spelling, printing, etc. Any small error may make the difference between drugs and poisons. If you cannot get to a decent library call or write one and for a small fee they will send you copies of the desired section of the Journal.

# REDUCTIONS

Since this is the most important step in the production of amphetamines, I have created a special section describing the preliminaries and techniques in great detail. After spending a lot of time and money to synthesize your nitropropene, you will be greatly disappointed to find that following the directions given in a journal is not enough to create an active compound. There are some minor pitfalls that many scientists figure all their readers already know about, but if they don't know about them, their reduction will fail miserably, wasting their time and the chemicals involved.

Although many formulas listed are designed specifically for reducing to amphetamine type compounds, they should work well on other drug synthesis calling for reductions. After finding a suitable or compatible reduction formula, replace the nitrostyrene or nitropropene, etc., with an equimolar ratio of the compound you wish to reduce. If I explained everything that I would like you to know about reductions, this chapter would be about 200 pages longer than it already is; obviously I cannot say everything, so I will stick with the basics.

Reductions in organic chemistry utilizing zinc, iron, and hydrogen sulfide, have been performed since the 1840's. Catalytic hydrogenation came about in 1897, and reduction with metal hydrides came into usage in 1947.

## *REDUCTIONS WITH METAL*

*Zinc.* Next to sodium, zinc is the most used reductant. It is available in powder, dust, and granular (mossy) forms. Zinc gets coated by a layer of zinc oxide which must be removed to activate it before it can reduce effectively. It can easily be activated by shaking 3 to 4 min. in a 1% to 2% hydrochloric acid solution. This means for every 98 ml of water volume, add 2 ml of concentrated hydrochloric acid. Then wash this solution with water, ethanol, acetone, and ether. Or activation can be accomplished by washing zinc in a solution of anhydrous zinc chloride (a very small amount) in ether, alcohol, or tetrahydrofuran. Another way is to stir 180 g of zinc in a solution of 1 g copper sulfate pentahydrate. Personally, I like the HCl acid method.

Mossy zinc is activated by converting to zinc amalgam by brief immersion in amalgam solution. (Use 40 g mossy zinc immersed in 4 g mercuric chloride, 4 ml concentrated HCl acid, and 40 ml of water.) This type of amalgam can be used with powdered zinc also.

Reductions with zinc are very effective on aromatic nitro compounds using organic solvents and an acid medium at around 50-70°. No matter what kind of metal is used, good stirring is a must. After the reaction is over, the zinc is filtered off, care being taken not to let it become dry, as it is pyrophoric. Also, be careful while disposing of zinc for the very same reasons.



*Zinc Reduction.* (This is a mild procedure used with great success on highly ring substituted derivatives.) CPB, 16(2), 217.

53 g of nitrostyrene (or equimolar amount of nitropropene) and amalgamated zinc (made from 200 g zinc powder and 20 g of  $\text{HgCl}_2$ , 20 ml coned  $\text{HCl}$  acid and 200 ml water; after a few min of agitation, decant the liquid off and use the wet zinc immediately) are suspended in 2 liters of ethanol. Under vigorous stirring, add coned hydrochloric acid until the yellow coloring of the reaction disappears (check by spotting on filter paper and allow to dry). Stir for an additional 30 min after the yellow color is completely gone, filter the zinc off, evaporate the ethanol off (alcohol smell will be gone after shaking), and pour residue into 1 liter of water. The aqueous solution is made alkaline with coned ammonium hydroxide after being washed with ether. The basic product is extracted into  $\text{CHCl}_3$  and evaporated to give 32 g of a light brown, viscous, oily substance. This is recrystallized from an acetone ethanol mixture to give the product a hydrochloride form.

*Another Zinc Reduction.* Prepare amalgamated zinc by treating 50 g of zinc with 5 g of mercuric chloride as above. Agitate the activated zinc in 100 ml of methanol using an ice bath (ice baths are actually ice water baths). Add to the above solution a small portion of hydrochloric acid, then a portion of the nitrostyrene (20 g) in 200 ml of tetrahydrofuran. The acid (in small amounts) and the nitrostyrene solution are added *alternately* with cooling to hold temp below  $50^\circ$ . After the styrene is completely added, check to see if the reaction mixture has lost the yellow tint by spotting on filter paper; add more small amounts of  $\text{HCl}$  acid if you can see a yellow tint. Filter the zinc off, remove the methanol tetrahydrofuran mixture by distilling in vacuo. Pour the residue into 500 ml of water (water is always distilled), wash with ether, basify with coned  $\text{NH}_4\text{OH}$  and extract with chloroform ( $\text{CHCl}_3$ ). Remove  $\text{CHCl}_3$  by evaporation to give a pale-yellow, oily compound (9.5 g) that is recrystallized from ethanol.

*Another Zinc Reduction.* Prepare or activate the zinc as follows: 400 g of mossy zinc is treated with 800 ml of 5% aqueous solution of mercuric chloride for 1 hour. Decant the solution off and use the zinc right away. Add .834 mole of compound to be reduced to the zinc amalgam, followed by as much  $\text{HCl}$  acid (.834 mole) diluted in as much water as is required to cover all the zinc. Reflux for 6 hours while adding small portions of dilute  $\text{HCl}$  acid. Cool, separate the upper, wash free of acid (a few portions of dilute sodium hydroxide), dry and distill to get about a 79% yield of product.

*Magnesium.* Halogen derivatives, like bromides, iodides, and imidoyl chlorides, react with magnesium to form Grignard reagents. Grignard reagents decompose with water or dilute acids to give compounds in which the halogen has been replaced by hydrogen. This replacement can also be carried out by the simultaneous action of isopropyl alcohol and magnesium activated by the addition of iodine (see *Wakefeld*, Smith, Org. Syn. Coll., Vol. 5, 998 (1973)). A magnesium amalgam can also be prepared to carry out certain reductions (see *Adams*, Org. Syn. Coll., Vol. 1, 459 (1932)). One thing to remember is that the entire operation must be kept dry. This requires the use of dry reagents, and no atmospheric  $\text{H}_2\text{O}$  is to enter the reaction, until the Grignard reagent has finished the job.

*To prepare the Grignard reagent.* All reagents must be thoroughly dry and the magnesium must be cleaned. To clean magnesium ribbons or pieces, sand thoroughly all the faces and edges with emery cloth. Wash free from sandings with ether and dry in oven at about  $109^\circ$ . Dry your reagents this way; allow your methyl iodide (or ethyl iodide, or n-hexyl bromide, or lauryl bromide, or 2-Br-heptane, or any other analog that your formula may specify) to stand over night, or for 12 hours over calcium chloride, and distill to purify. Dry ether as specified in the precursor and

reagents section of this book, or purchase dry. **Here** is a typical formula for preparing and using a Grignard reagent.

36 g (1 mole) of methyl iodide (or 1 mole of specified analog) are mixed with 50 cc of dry ether. 20 cc of this mixture are run into a flask fitted with a long reflux condenser and an addition funnel 6 g of clean magnesium (this can be purchased by the block, and after sanding a side, clean chisel or cut thin shavings off, wash and dry as above) are placed in the reaction flask before the 20 cc of the iodide-ether mixture are run in. It is sometimes necessary to add a crystal of iodine to start the reaction or to reduce the more stubborn compounds, e.g., the nitriles leading to Amidone. When the reaction first subsides, add 70 cc of dry ether and run the remainder of the methyl iodide-ether solution into the reaction flask one drop at a time from the addition funnel. After the addition, reflux or boil gently on water bath until all, or almost all, the magnesium has dissolved.

Rig down the apparatus, and with external ice cooling, add 1 mole of the compound to be reduced (e.g., the high or low melting nitrite intermediate for Amidone or 3, 5 dimethoxy benzamide or 3, 5 dimethoxy benzaldehyde for THC formulas, etc.), after mixing with an equal volume of dry ether, by dropping in with an addition funnel while shaking or stirring. Allow to stand for 12 hours after the addition. This last paragraph and the one to follow describe a general method. If you have specific or special instructions regarding the addition and removal of your compound, by all means use those. If you have no special instructions (e.g., react with Grignard reagent or react with ethyl-Mg-bromide) then use ethyl bromide or a suitable analog and follow the procedure given here.

While stirring and cooling, add just enough dilute HCl acid to dissolve the precipitate. (*Note: different acids in different concentrations are sometimes used*) Separate the aqueous layer and wash the ether with sodium bicarbonate solution and sodium bisulfite solution (in that order; bisulfite removes free iodine) and again with sodium bicarbonate solution. Dry over suitable drying agent and evaporate or heat gently (in dry atmosphere) to remove the ether. Purify by fractional distillation,

*Aluminum.* Reductions with aluminum are not commonly found, however, I have included the preparation of the amalgam. Aluminum can be used to reduce aromatic nitro compounds (Org. Syn., 52, 77(1972).

*Aluminum Amalgam.* Immerse thin strips of aluminum foil in a two percent aqueous solution of mercuric chloride for 30-60 seconds. Use a big bowl and plenty of solution for a moderate amount of foil. Decant off the solution, rinse the foil strips with dry ethanol, ether, and cut them into pieces of about 1cm<sup>2</sup>.

*Iron,* Iron reductions have been used for over 130 years. About the only reductions using iron are those for aromatic nitro compounds. They are not used much these days in drug synthesis, so I will not elaborate further.

*Tin,* If you should happen to run into a reduction using tin, prepare the following amalgam as follows.

*Tin Amalgam.* To a solution of 15 g of mercuric chloride in 100 ml of water, add 100 g of 30 mesh tin metal while stirring briskly. Let set for a few seconds after several min of stirring to see if the tin has acquired a shiny coating of mercury; if not, stir or shake for 30 sec. more and check again. Decant the liquid and wash the tin amalgam until the washings are clear. This can be stored under distilled water for a moderate amount of time.

*Catalytic Hydrogenation.* General statements about catalytic hydrogenation are difficult to make since the results are affected by many factors such as the catalysts, activators, inhibitors, solvents, pH of the medium, temp, and pressure.

*T-1 Raney Nickel Catalyst.* To prepare, proceed as follows: in a one liter three necked flask containing 600 ml of a 10% sodium hydroxide solution, 40 g of Raney nickel aluminum alloy (50%) is added in small portions. During the addition the temp should be 90-95° and there should be good stirring (do not use a magnetic stirring device). After the addition is complete (25 to 30 min), stir for 1 hour more, and let the nickel settle to the bottom of the flask. Decant the solution off, wash with 5 times 200 ml of water, 5 times 50 ml of ethanol, in such a way to keep the nickel always covered with liquid. The catalyst must be stored under ethanol and refrigerated. It may be stored for three months and remain active.

*General Method of Hydrogenation Using Raney Nickel.* This method may be altered to use larger formulas. If you have a formula giving specifics, then use it. Using a Parr low pressure hydrogenation bottle is recommended. 0.1 to 0.4 mole of the compound to be hydrogenated is suspended or dissolved in 30-80 ml of ethanol. 5-10 g of the above catalyst is added with good stirring, followed by 1-2 ml of 20% NaOH solution. The hydrogenations are carried out at 40-50° and 40-50 psi. The reduction product is separated and purified depending on its physical properties.

*Method of Hydrogenating With Raney Nickel Catalyst.* This method gets the hydrogen atmosphere from the NaBH (sodium borohydride) that is added directly to the mixture instead of piping the hydrogen in. It is useful for converting phenylacetonitrile into the corresponding phenethylamine. 40 g of phenylacetonitrile in 90 ml of methanol are stirred and 10 g of the above prepared catalyst, or nickel analog, are added. With good stirring, add dropwise, over ten min a solution of 7.6 g NaBH in 25 ml of 8N sodium hydroxide with external cooling to keep temp at 50°. H<sub>2</sub> stops being produced about 5 min after the addition is complete. Filter and wash with methanol to get the amine. (See "precursors" to make phenylacetonitrile.)

*A Different Method.* JMC, 14, 375 (1971). A solution of 16 g of phenylacetonitrile (see methadone in the analgesics chapter for the formula to diphenylacetonitrile which may work here for analog), in 60 ml of MeOH that contains 8.3 g of NH<sub>3</sub> and 10 ml of Raney Ni catalyst slurry are placed in a 300 ml stirring autoclave, or a pressure cooker that has a glass or ceramic liner capable of withstanding the pressure stated. Pressure autoclave to 105 kg/cm<sup>2</sup> with hydrogen tank (these are sometimes referred to as bottles and can be purchased at most any welding or gas supplier). Make sure your fittings and lines are tight and capable to withstand the pressure required. Stirring or shaking and heating to 125° for two hours follows immediately after the hydrogen pressurization. Filter, evaporate the methanol and distill in vacuo the residue, saving the fraction at 110-115° at 0.4 mm of vacuum. To get the hydrochloride form, add the above product to Et<sub>2</sub>O and treat with dry HCl. Recrystallize from EtOH-EtOAc-Et<sub>2</sub>O. *Note:* 105 kg/cm<sup>2</sup> - 1500 p.s.i.

*Platinum.* Platinum oxide is the most common catalyst although there are others. This is a brown, non-pyrophoric, stable powder made from fusing chloroplatinic acid and sodium nitrate. It is considered among the most powerful catalysts, each molecule of this catalyst requires two molecules of hydrogen, and this amount must be subtracted from the final volume of hydrogen used in exact hydrogenations. It is suitable for almost all hydrogenations, being able to stand strong acids. Platinum catalysts are more effective and easier to buy than to make.

*Platinum Reduction for Reducing Ketones or Aldehydes.* JACS, 70, 1316 (1948). This is a good, easy method requiring little pressure. In a 300 ml Parr hydrogenation apparatus containing 10 ml distilled water, 0.2 g of platinum oxide is reduced to platinum by shaking in a hydrogen atmosphere for ten min. Other catalysts can be substituted; if they are not an oxide then this first step should be unnecessary. Benzylmethyl ketone (0.3 mole) or phenyl-2-propanone, or analogs (see precursor section for intermediates synthesis), 20 g (0.37 mole) of ammonium chloride, 225 ml of dry methanol that has been saturated with ammonia, and 25 ml of aqueous ammonia are added together and reduced by shaking with one to three hydrogen atmospheres. Good shaking is required during this operation and is continued until the pressure remains constant indicating that the reduction is complete. Filter after venting and wash the solids in the filter paper with water or methanol to get all the product into the filtrate. Reflux the filtrate to remove the excess ammonia. With the ammonia removed, the solution is cooled, acidified to congo red paper with coned HCl acid, and evaporated to *Vi* its volume under vacuo.

Add 200 ml of water and extract with 3 times 25 ml of benzene. Discard the benzene extracts as they do not contain product. The remaining aqueous solution is made strongly basic with 50% NaOH solution. An oily layer and a water layer will form. Separate the layers and extract the water layer 3 or 4 times with ether. Combine the ether extracts with the oily layer and wash with water. Fractionally distill to get purified phenethylamine. Yield: 69%.

*Another Hydrogenation with Platinum Oxide.* JACS, 55, 2694. This method is used to reduce those hydrox-mandelonitriles in the amphetamine section. It uses low pressure and can be used on about any reducible compound. It can also use palladium oxide as the catalyst. A solution of 35.8 g of phenyl-2-propanol in 250 ml of 80% ethanol containing 7.3 g of HCl is hydrogenated for 3 hours in a Parr hydrogenation bottle at 3,5kg/cm<sup>2</sup> or 50 p.s.i, over 0,5 g of platinum oxide (or palladium oxide; Raney nickel may also work) or an equimolar ratio of analog catalyst for about 3 hours. Filter off the catalyst and rinse with a little water to wash all the product from the catalyst. Dilute the filtrate to 1 liter of volume with water and extract twice with ether to remove any acid insoluble material. The ether extracts do not contain product. The aqueous layer is made alkaline with solid NaHCO<sub>3</sub> to a pH of 8-9 and the basic oil which separates is extracted with two 300 ml portions of ether. This ether solution is dried over MgSO<sub>4</sub>, and filtered, then evaporated to remove the ether. To convert to the oxalate, add ether to the crude product and add to a solution of 9.6 g of oxalic acid dihydrate in a small volume of methanol. Give ample time to crystallize and then recrystallize from methanol. Yield: 31.2 g, mp: 134-135°. Yield: -wvovovxv tonvcrxng to the oxalate, 27.5 g, mp; 54-55°.

*Palladium.* Palladium catalysts are much like platinum, but a little more versatile. Palladium oxide is made by heating palladium chloride with sodium nitrate to fusion at 575-600°. Use palladium oxide (an equimolar amount) in the formulas already given for reducing with platinum oxide. Below is a reduction with palladium-carbon.

*Reducing With Palladium-Carbon.* Dissolve 0.02 mole of nitropropene or nitrostyrene in 250 ml glacial acetic acid. Add one gram of palladium-carbon catalyst (or analog) followed by 10 ml of coned sulfuric acid. Reduce at 2 atmospheres by admitting hydrogen from bottle. It should only take about 15 min to complete, filter, add 36 ml of 5N NaOH and evaporate in vacuo to get the amine. (I am not sure if this is purified, good enough for me to take.) For another catalytic reduction of nitropropenes see JOC, 37, 1861 (1972).

*A Different Nickel Catalyst.* This can be used instead of Raney nickel catalyst. It is effective and cheap and it does not cause suspicion with the law.

Make a solution of 1.25 g of powdered nickel acetate in 50 ml of 95% ethanol in a 250 ml flask. Add 5 ml of 1M solution of sodium borohydride in 95% ethanol at room temp. Stirring is continued until gas stops evolving (about 30 min). The flask along with the colloidal substance is now used directly in the hydrogenation.

*A General Method For Making Raney Nickel Catalyst.* Mix an alloy consisting of 50% nickel and 50% aluminum (they should be clean and pure). To make the catalyst stronger use less aluminum, but never use under 11%. Add the alloy to 25% to 50% sodium hydroxide water solution and heat to 50-100°. Wash with plenty of water (always use distilled water in an organic lab) and then with ethanol as instructed in the T-1 catalyst described above. These catalysts are pyrophoric and should never be allowed to dry once prepared. Store under ethanol. The T-1 is about the strongest, using the 50/50 alloy rereacted with another 50% aluminum.

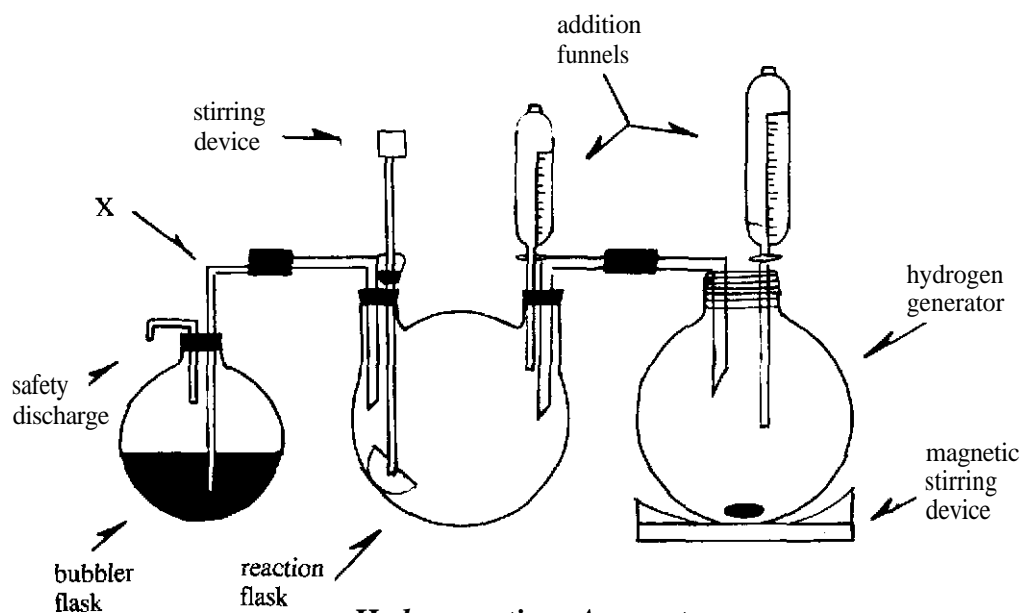

**Hydrogenation Apparatus**

*Apparatus for Hydrogenation at Atmospheric Pressure*

Without any idea of what hydrogenation apparatus should look like, carrying out the process would be rather difficult. Along with the pictures are general instructions for proper procedure. If you are following a specific formula then you may need to change things around to produce the desired product.

*Catalytic Hydrogenation by Generating Hydrogen From Sodium Borohydride.* The reaction and generator flasks should be 500 ml size. The reaction flask is charged with 100 ml of ethanol, 5 ml of a solution of 0.2 M chloroplatinic acid, and 5 g of activated charcoal, and if possible, the entire apparatus is flushed with nitrogen. The addition funnel over the H<sub>2</sub> generator is filled with 150 ml of 1 M sodium borohydride solution in 1 M NaOH. A 1 M solution of 1 M NaBH<sub>4</sub> in 20 ml of ethanol is added to the reaction flask with vigorous stirring to prepare the catalyst. 5 ml of coned HCl acid are added to the generator flask; insert the addition funnel back into the generator flask, turn on the magnetic stirrer and add 30 ml of 1 M NaBH<sub>4</sub> to flush the apparatus with H<sub>2</sub>. The hydrogen discharge line (X) should not be immersed in the mercury until this procedure is complete. Now you already have a prepared catalyst and a H<sub>2</sub> atmosphere so

you may add a solution containing 0.5 mole of the compound to be reduced to the reaction flask making sure that you have closed all valves and have no leaking joints. The discharge line (X) is an indicator that keeps excessive pressure from blowing the apparatus apart. It should not be immersed too deeply into the mercury, and will allow bubbling if pressure is getting too high. (If the line can be immersed deeply into the mercury without destroying the apparatus, then this is great.) If mercury rises up into the discharge line then you need to add more  $\text{NaBH}_4$  to the generator (a few drops at a time), as the reaction is using up  $\text{H}_2$ . Sodium borohydride can sometimes be added to the reaction directly, therefore eliminating the need for a generation flask. Use (HCA, 53, 50) above formula utilizing Raney nickel and atmospheric pressure and the apparatus without the generation flask.

There are many scientific supply stores that sell some very nicely engineered glassware designed to do this job perfectly. It is expensive and so I have shown the low budget type of set up. The flasks still need to be high quality and vacuum proof, as is the tubing and connection hosing. Clamp the hosing and use a mercury type seal on the stirring device; magnetic stirring devices should not be used with metallic catalysts as they conglomerate the catalyst to the stirring bar by magnetic force.

If your apparatus blows apart with regularity, replace mercury with water, but use a water trap between it and the reaction vessel,  $\text{H}_2$  can be bought and piped into the reaction.

*Hydrogenation at Medium Pressure.* This costs more to get started, but it is cheaper than  $\text{NaBH}_4$  if used on a large scale. The best equipment needs to be used, with no skimping. A regulator should be used on any gas coming from a high pressure tank (bottle) into a reaction apparatus of any type. A stainless steel bomb of about 500 ml can be ordered or made by most any metal fabrication company for less than a chemical supplier. Make sure these outfitters know that the pressures required are up to 150 atmospheres. Use standard high pressure fittings, valves, hoses and tubing.

After assembling the apparatus as shown, using teflon tape on all threaded parts (including the cap fitting) and tightening all threads until they are buried deeply into the fittings, the apparatus must be tested. This test *must* be performed before every use. Attach the high pressure hose to the inlet valve and to the  $\text{H}_2$  tank regulator. Pressurize to about 100 atmospheres (at least 25 atmospheres more than what you intend to use for your hydrogenation product). Make sure both the inlet and outlet valves are closed tightly and watch the gauge for about 10 min to see if pressure drops. If pressure will not remain constant you have a leak and it *must* be fixed before attempting to perform the hydrogenation. Use soapy water to cover unions and valves to find the leak. After passing the pressure test, bleed off hydrogen very slowly by opening the discharge valve and watching the gauge closely, stop opening just as soon as pressure begins to drop. The discharge hose does not need to be high pressure, but it does need to be attached to a vacuum aspirator to evacuate the  $\text{H}_2$ . Do not evacuate the

NOTE:

All fittings must be high pressure.

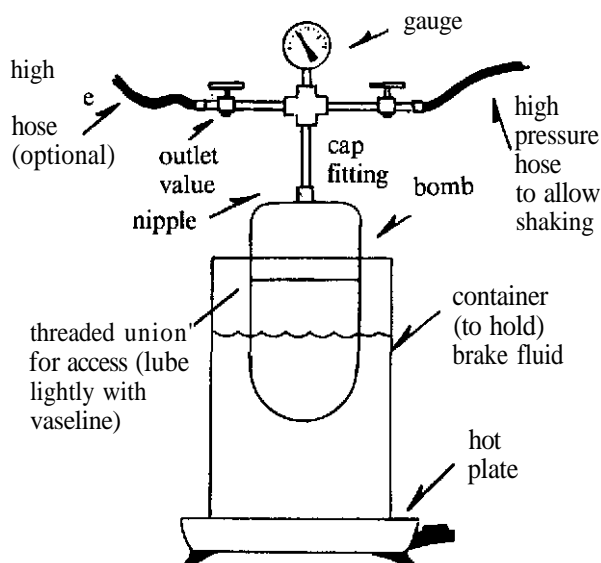

$\text{H}_2$  faster than the aspirator can remove it. Disconnect the cap fitting, charge the bomb with catalyst, compound to be hydrogenated, and with solvent if required. Again use teflon tape and retighten the cap fitting securely. Pressurize to 75-100 atmospheres and see if the pressure drops immediately. If so you have a leak and it needs to be fixed. After a few min (no more than 6) a small decrease in pressure must be noted to indicate that the reaction is processing. Close inlet valve and bleed off pressure through the outlet to flush apparatus of air that entered while you charged bomb with catalyst. Perform hydrogenation as per the instructions of your formula.

The pressure rating of your formula *must* be well below the pressure rating of your apparatus as exothermic temp raises the pressure considerably. Vigorous shaking should be performed from the time flushing is finished until the reaction is complete. Mechanical devices can be rigged up to save your arm wear. When the pressure no longer rises or falls, this indicates that the reaction is complete. If the pressure drops too low, then you may need to add more  $\text{H}_2$ . If the hydrogenation fails, you may try again at a higher temperature.

Some formulas call for elevated temperatures. This can be accomplished by using an oil bath as shown in the picture on page 34. The  $\text{H}_2$  pressure will rise (unlike the operation at room temp) due to the rise in temp. After the temp has stabilized, any drop in pressure indicates that hydrogenation is taking place. Stirring and heating are continued until no more  $\text{H}_2$  absorption is evident at that same temp. After you are sure the hydrogenation is finished and the pressure is bled off completely through the discharge valve, check to make sure the hydrogen tank and regulator are both closed tightly. Now and only now are you allowed to disconnect the bomb. Filter the contents of the bomb and rinse several times with small amounts of suitable solvent. Use these bomb rinses to wash product from catalyst as it sits on the filter paper, using care to keep pyrophoric catalysts wet at all times. Work the filtrate up as required for the properties of your specific product.

*Note:* After you have pressurized the bomb and closed the inlet valve to perform the hydrogenation, you must remember to close the master valve on the hydrogen tank. Also those huge cylinders (bottles, tanks) that you see on welding apparatus are not required, as smaller tanks are available and they contain more than enough pressure to do the job.

*Hydrogenation at High Pressures.* These are carried out almost exclusively in autoclaves. Autoclaves are much like the apparatus previously shown, but with much more steel to withstand the high pressures and temperatures they receive. Most of them have built-in heating elements and temperature indicators. Yes, they are very expensive, I have seen some homemade units that functioned quite effectively but I do *not* recommend that you try to build one. If you do try to build one, know what extremities the unit will be subject to and get professional advice and assistance for construction. Because medium and no pressure hydrogenations are so effective, I will not elaborate on high pressure systems any further.

## ***REDUCTIONS WITH HYDRIDES***

This requires a little knowledge in handling before attempts are to be made at reducing. Here are some things to remember.

1. Sodium borohydride and sodium cyanoborohydride have been known to explode upon removal of a screw cap from a glass bottle.
2. Lithium aluminum hydride should be stored in polyethylene bags, not ground glass bottles.

3. Lithium aluminum hydride squeezed, or smashed, may cause a fire.
4. Contact of lithium aluminum hydride with water may cause fire or explosion.
5. Borane (sometimes called diborane) ignites when in contact with air, so it must be covered with tetrahydrofuran, always.
6. Contact with water may ignite sodium aluminum hydride.

*A Typical Lithium Aluminum Hydride Reduction.* JACS, 72, 2781 (1950). To a well stirred mixture of 53 g lithium aluminum hydride (LAH) and 2500 ml of dry ether is added 55 g of 4-hydroxy-3-methoxy-B-nitrostyrene (or equimolar ratio of nitropropene or analog) in 150 ml of dry ether over an hour and 20 min. Stir and reflux for about 9 hours, taking care to exclude all moisture. Cool and add 3000 ml of ice cold 1.5 N sulfuric acid dropwise with good stirring (the acid addition can be speeded up after about half of it has been added). The water layer is separated and its pH adjusted to 6 with solid lithium carbonate. This solution is heated to boiling and the aluminum hydroxide that precipitates is filtered off. The hot filtrate is mixed with a solution of 70 g of picric acid in the minimum amount of hot ethanol that it takes to dissolve the picric. Let stand for 4 hours, filter and recrystallize from water.

88 g of the above picrate product in 1 liter of water is mixed with 400 ml of coned hydrochloric acid. The picric acid which precipitates is filtered off and the filtrate is extracted with nitrobenzene and then with ether (extra ether extracts may eliminate the need for nitrobenzene). The aqueous solution is evaporated (reduced pressure is fastest) to dryness, dissolved in methanol-ethyl acetate, and filtered hot. You may filter off the crystals before they reach complete dryness if you would like to sample a little while waiting. Yield, 90%. This is a gentle reduction made from Tyramine, but it can be used on most any reducible forms. See the amphetamines chapter for formula (JACS, 72, 2781, 1950) of 4-hydroxy-3-methoxy-B-nitrostyrene and analogs. For a reduction using the reverse addition of LAH and several other reductions see the amphetamine chapter.

*A Reduction With Aluminum Hydride (Alane).* In a three necked 1 liter flask equipped with a gas tight mechanical stirring device, an addition funnel, and a long reflux condenser, is charged with 0.1 mole (3.8 g) of LAH and 100 ml of dry ether. Add a solution of 0.1 mole (13.3 g) of aluminum chloride (dry or anhydrous) rapidly through the dropping funnel, continuing the stirring the entire time. After five min, add 0.1 mole (16.3 g) of nitrostyrene, or analog (see amphetamines section), in 200 ml of ether to the well stirred reaction, dropwise. One hour after the nitrile addition add dropwise enough water (until the bubbling stops) to decompose the excess hydride (or halide). Then add 140 ml of 6 N sulfuric acid diluted with 100 ml of water. Separate the ether layer and extract the aqueous layer with 4 100 ml portions of ether. After cooling the aqueous layer is alkalinized with powdered KOH to pH 11, diluted with 600 ml of water, and extracted with four 100 ml portions of ether. The combined ether extracts are stirred with Drierite and evaporated under reduced pressure. The residue (21.5 g) is distilled to give corresponding product. Although there is no reference for this method, the yield is 90%.

*Sodium Reductions,* Reductions using sodium are becoming increasingly rare, but they do exist. In case you should find a formula requiring a sodium amalgam, I have given the preparation.

*Sodium Amalgam.* 5 g of clean sodium are cut into 3-5 mm squares. Each individual cube is placed on the surface of 245 g of mercury in a dish and held underneath the mercury with a glass spoon until dissolved. The remaining sodium cubes are treated the same way, as soon as possible. After the sodium has been added, the mixture is allowed to cool, solidify, and then is crushed. Store in a closed bottle.



This reaction is highly exothermic, so heat is normal. If the formula does not specify the sodium amalgam then do *not* use it (e.g., the first formula in the amphetamines chapter).

*Reduction with LAH and Aluminum Chloride.* This gives some of the best yields possible, of all reductions known to me. It is designed to reduce phenylacetonitriles but may also be used to give high yields with reductions of nitropropenes, etc. It is used for reducing diphenylacetonitrile (see analgesics, the Amidone formula, for the synthesis of diphenylacetonitrile), to give diphenylethylamine; however, phenylacetonitrile may also be used to give phenethylamine (see precursors section to get several different formulas for phenylacetonitrile).

*JACS, 77, 2544 (1955).* In a 1 liter 3 necked flask fitted with a mercury sealed stirrer, a reflux condenser, and an addition funnel, is placed a solution of 0.1 mole of LAH in 100 ml of dry ether. Through the dropping funnel, a solution of 0.1 mole (13.3 g) of aluminum chloride in 150 ml of dry ether, is added to the LAH solution rapidly. Next a solution of 0.1 mole (19.3 g) of diphenylacetonitrile (or an equimolar amount of analog) in 200 ml of dry ether is added dropwise to the well stirred mixture. An evolution of hydrogen should be noted. After the addition is complete, continue stirring for 1 hour, then add water to decompose the excess hydride. Add 140 ml of 6 N sulfuric acid and 100 ml of water. Separate the ether layer and extract the aqueous layer in an ice-water bath and add KOH until the pH is 11, then extract with four more 100 ml portions of ether after diluting with 600 ml of water. Combine the ether extracts, dry over Drierite and evaporate the ether off. Fractionally distill through a 12 inch column at about 184° using 17 mm of vacuum. Yield: 91%.

*Note:* Always add water slowly to hydride type substances when decomposing them; when bubbling stops they are usually decomposed.

# AMPHETAMINES

This chapter contains all the goodies so dear to all you speed freaks. It also contains several formulas for mescaline. I chose to put mescaline in this chapter instead of the hallucinogen section because the mescaline molecule is basically the same as any amphetamine. It is correct to say that mescaline is the grampa of speeders and the relation is obvious by the similarity of their synthesis. Whether you call it phenethylamine, amphetamine, phenylisopropylamine, aminoethylbenzene, phenylaminopropane, desoxyephedrine, etc., the molecule is good old mescaline with a few minor changes. However, these minor changes can cause drastic changes in activity and psychotomimetic effects.

The criteria of molecular structure of amphetamine-like compounds are a benzene ring with an aliphatic chain of two or three carbon atoms with an amino-group ( $-NH_2$ ) on the second or third carbon atom. There are exceptions to this rule (Tuamine, and Privine, etc.), but generally we will need a benzene ring to use as starting material for our speed. What kind of benzene ring? Some formulas call for allyl benzene, but most require you to change the allyl to propenyl benzene. Then we must nitrate the benzene ring with lovely things like rocket fuel. (Now can you see why I want you to purify as specified in the formulas?) Next, the nitropropene or nitrostyrene (a nitrated benzene) must be reduced; this is related to hydrogenation. This is the most common method, it is fairly easy and inexpensive. However, I have included many other ways. Choose a formula that suits your needs.

## PHENYLETHYLAMINE

50 g of benzylmethyl ketone, or analog, in 100 ccs absolute ethyl alcohol are placed in a liter round bottom flask having a long neck. The flask is fitted with a three way or claisen adapter (see Figure 20) which has a water jacket condenser fitted to the sloping limb and a stopper in the vertical limb. A bottle, containing benzene and bright pieces of sodium (50 gms.) of such size that they are easily dropped down the vertical limb, is prepared. The flask is heated on a water bath until the alcohol boils. The pieces of sodium are then (one at a time) introduced through the vertical limb. The benzene adhering need not be removed from the sodium. The first pieces of sodium cause a vigorous reaction, but the alcohol is kept at a boil. When the reaction becomes sluggish a further 100 ccs of absolute alcohol is added and brought to a boil, and the sodium is again added. This is continued until 500 ccs of alcohol and

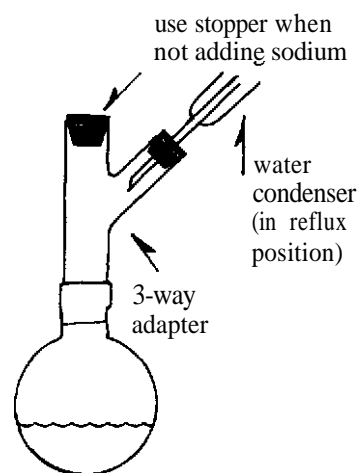

40 gms of the sodium have been added altogether. Then the following test should be carried out to show that the reduction is complete.

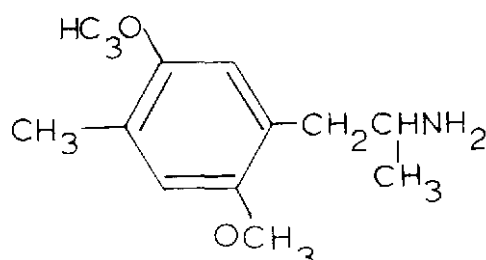
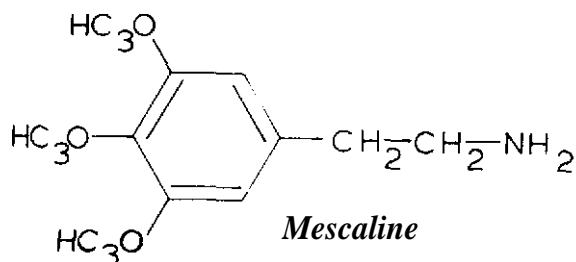

***l*-(2,5-Dimethoxy-4-methyl-phenel)-2-aminopropane  
(DOMorSTP)**

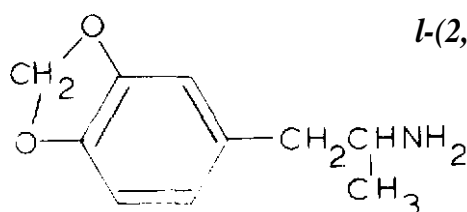

***3,4*-Methylenedioxyamphetanune  
(MDA)**

### ***Molecular Structure of Some Amphetamines***

A sample (2 ccs) is diluted with 2 ccs of coned hydrochloric acid. This mixture is boiled with Fehling's solution (1) prior to the addition of Fehling solution (2). If no reduction of the Fehling solution takes place the reduction of the oxime is finished.

When the reduction is complete and all of the sodium is dissolved, (Fehling's test can be bypassed by adding an approximate total of 45 to 50 gms. of sodium and dissolving completely; I do not recommend this as it may hurt the yield) the flask is cooled, and 200 ccs of water are added to decompose the ethoxide. The water condenser that had been rigged to reflux is now sloped to distill. Heating is continued on a water bath until distillation slackens. A further 200 ccs of water are added and the heating is now performed on a sand bath until all the alcohol has passed over and the distillation has reached a temp of 96°. The contents of the flask, consisting of a layer of amine and a layer of caustic soda, are cooled and poured into a separating funnel. A little ether is used to complete the transference of the amine. The total distillate, containing alcohol, water, and phenylethylamine, is made strongly acidic with HCl acid (use a good PH indicator) and evaporated to a small bulk (a vacuum will speed this), after which the residual aqueous solution of amine hydrochloride is added to the contents of the separating funnel, where the excess of caustic soda liberates the base. After some time of standing, the lower layer of caustic is run off, the upper layer of amine is agitated with 20 ccs of 0.720 ether, and the final traces of caustic are separated. The product from the reduction of a number of 50 gm installments of benzyl methyl ketone can, with advantage, be united at this stage. The ethereal solution along

with the ethereal washings are dried over anhydrous sodium sulfate and distilled. At first, ether containing some amine passes over, this portion is kept separate for recovery as carbamate (it is alkaline to litmus). The temp of the distillate coming over then rises rapidly to 186°-187°, at which time the amine distills. The condenser which should be long, is only filled half way with water at this stage. The receiving flask should be fitted with a soda-lime filled drying tube, owing to the avidity of the amine for carbon dioxide. Yield: 90% theoretical (40 gm).

*Phenylethylamine*. Bp: 186°; easily soluble in organic solvents; moderately soluble in water; strong base; absorbs carbon dioxide from air.

### **4-METHOXYPHENYLETHYLAMINE HYDROCHLORIDE**

p-Anisyl alcohol 100 g (0.725 mole) is shaken with 500 ml of coned HCl for 2 min. The organic phase is washed with H<sub>2</sub>O, then 5% NaHCO<sub>3</sub>, and again with H<sub>2</sub>O, then added (over 40 min) to a stirred slurry of 49 g (1.0 moles) of NaCN in 400 ml of DMSO, with ice water to maintain the temperature at 35-40°. After the addition is complete, the cooling bath is removed, the mixture is stirred for 90 min and added to 300 ml of H<sub>2</sub>O, and the small upper phase separated. The aqueous DMSO layer is extracted with two 100 ml portions of Et<sub>2</sub>O, which are combined with the product phase, and the whole is washed once with H<sub>2</sub>O and dried with MgSO<sub>4</sub>.

A dry flask is charged with 600 ml of absolute Et<sub>2</sub>O and chilled in ice as 80 g (0.6 mole) of anhydrous AlCl<sub>3</sub> is added portionwise, followed by 23 g (0.6 mole) of LAH. The dried Et<sub>2</sub>O solution of crude p-methoxyphenylacetonitrile is added at such a rate as to maintain gentle reflux without external heat (approximately one hour). The mixture is stirred for 2 hours, then chilled in ice, and treated dropwise with 25 ml of H<sub>2</sub>O followed by 250 ml of 20% aqueous NaOH, with periodic additions of Et<sub>2</sub>O through the condenser to replenish losses and facilitate stirring. The resulting voluminous, granular ppt of NaCl and LiCl and aluminate is removed by filtration, washed well with Et<sub>2</sub>O, and discarded. The filtrate is mixed with one-third its volume of absolute EtOH and 60 ml of coned HCl is added slowly with continuous swirling and ice cooling. After cooling to 0°, the crystal amine hydrochloride is collected. Yield: 75% (101 g), m.p.: 212-214°. The hydrochloride may be recrystallized from Et<sub>2</sub>O-EtOH, or i-PrOH.

*Note:* The above formula is obviously a rapid, convenient procedure, and eliminates the need to isolate intermediates and other time consuming operations. The procedure above is described for the p-methoxy derivative, a potent but toxic drug. If you wish to avoid the toxic quality of the p-methoxy derivative the formula may be used to make other phenethylamines without substantive modification.

The formula on the next page is designed to methylate amphetamines, which are usually more stimulating and pleasant than the non-methylated versions. This formula is also described for the p-methoxy derivative and it too may be used to methylate most phenethylamines without substantive modification. They were taken from JMC, 15, 214. The alcohol p-anisyl is replaced with trimethoxybenzyl, you get mescaline.

***N-METHYL-p-METHOXYPHENYLETHYLAMINE  
HYDROCHLORIDE JMC, 15, 214(1972)***

p-Methoxyphenethylamines, generated from 100 g (0.536 mole) of the hydrochloride by stirring with aqueous coned NaOH, is treated with 100 ml of PhH and 70 g (0.66 mole) of PhCHO. A mildly exothermic reaction begins at once. The mixture is heated under reflux until no more H<sub>2</sub>O is present in the condensate (about 1 hour), then, without cooling, an attached Dean-Stark trap is removed and a solution of 82 g (0.65 mole) of Me<sub>2</sub>SO<sub>4</sub> in 200 ml of PhH is added through the condenser at such a rate as to maintain reflux (15 min). The two phase mixture is heated for 90 min on the steam bath, cooled slightly, treated with 200 ml of H<sub>2</sub>O, and heated for an additional 20 min. After cooling on ice, the aqueous layer is washed twice with Et<sub>2</sub>O to remove the unreacted PhCHO and then made strongly basic with 50% aqueous NaOH. Two Et<sub>2</sub>O extracts of the basic aqueous phase are added to the amine layer which separated, and the resulting solution is evacuated at the aspirator for 30 min, leaving 90 g of crude product. This material is dissolved in 500 ml of 20% absolute EtOH-Et<sub>2</sub>O and treated with 50 ml of coned HCl with swirling and cooling to yield the white, crystal hydrochloride, which is washed thoroughly with ice cold 20% EtOH-Et<sub>2</sub>O and dried. Yield: 77% (83 g), mp: 185.5-186.5°.

***4-BROMO-2,5-DIMETHOXYAMPHETAMINE***

This is the most potent amphetamine type of drug known to me. It is about ten times more powerful than 2,5-dimethoxy-4-methylamphetamine (sometimes called DOM or STP). DOM is 100 to 150 times more powerful than mescaline, making the average dose very small. When selling drugs as potent as these, you should make sure people know how much a safe dose is or cut the drug accordingly with a compatible substance. The formulas were taken from different references to allow you to make the drug as easily and completely as possible.

2,5-Dimethoxybenzaldehyde can be purchased from chemical supply houses for \$25 per 75 gms or it can be made from the formula given in the precursor section of this book.

*2,5-Dimethoxy-4-Bromobenzaldehyde.* JMC, 14, 372 (1971). 2,5-Dimethoxybenzaldehyde 66 g (0.4 mole) is dissolved in 300 ml of CH<sub>2</sub>Cl<sub>2</sub>. 115 g of anhydrous SnCl<sub>4</sub> (0.44 mole) is added, followed by 64 g of Br<sub>2</sub> over a one hour period. The resulting solution is refluxed for two hours and then stirred overnight at room temp. The orange suspension is poured over 500 g of ice, and the layers are separated. The CH<sub>2</sub>Cl<sub>2</sub> layer is washed with 10% NaHCO<sub>3</sub> and H<sub>2</sub>O and dried with Na<sub>2</sub>SO<sub>4</sub>. After filtration the solvent should be removed in vacuum, and the solid residue recrystallized from MeOH-H<sub>2</sub>O. Yield: 66% (64 g), mp: 132-133°.

*Substituted-1-Phenyl-2-Nitropropenes.* JOC, 18, 1 (1953). 5 g of 2,5-Dimethoxy-4-bromobenzaldehyde, 5 ml of nitroethane (EtNO<sub>2</sub>), and 2 g of ammonium acetate are added to 20 ml of glacial acetic acid. The resulting solution is refluxed for two hours and poured into ice water. If a solid product is obtained it is collected and recrystallized from methanol, ethanol, or acetic acid. If the product is an oil it is separated and crystallized from one of the above.

*4-Bromo-2,5-Dimethoxyamphetamine*, This should be prepared by reducing the above nitropropene with LAH as described below. Other reductions may or may not be compatible with the electronic character of the bromine atom. This particular reduction can also be used to reduce most any nitrostyrene, nitrobenzene, etc. *Note:* These will work too, CPB, 16, 217 or JACS, 72, 2781, also found in this book.

In a three-necked two-liter flask equipped with a mechanical stirrer, dropping funnel and a condenser through which a low temp thermometer is suspended (openings protected by drying tubes), is added a solution of 12.2 g (0.075 mole) of the above substituted 1-phenyl-2-nitropropene in 300 ml of absolute ether and cooled below  $-30^{\circ}$  with an acetone-dry-ice bath. With rapid stirring, a solution of 4.25 g (0.112 mole, the calculated amount for the reduction of the nitro group) of lithium aluminum hydride in 100 ml of absolute ether, was added at such a rate that the temp of the reaction mixture was maintained between  $-30$  to  $-40^{\circ}$ . Exothermic reaction progresses during the addition and the color of the nitro-olefin will be discharged. The temp in the reaction flask is then allowed to fall below  $-40^{\circ}$ , the freezing bath is then removed and the temp allowed to rise to  $15^{\circ}$ . Hydrolysis is carried out with 400 ml of 20% aqueous sodium tartrate. The addition of the first few drops of this solution will cause a slight reaction indicating that the hydride is not completely utilized. The aqueous layer is extracted with two additional 50 ml portions of ether and the combined ethereal extracts, after drying over Drierite, yields the product on rectification. Yield: 44% (4.4 g) of substituted phenylisopropylamine, bp:  $72-74^{\circ}$ , and 23% (2.6 g) of phenylisopropyl-hydroxylamine m.p.  $116-118^{\circ}$ .

Phenylisopropyl-hydroxylamine can be reduced to phenylisopropylamine as follows: A solution of 6g (0.04 mole) of phenylisopropyl-hydroxylamine in 80 ml of absolute ether is treated with 1.9 g (0.05 mole) of LAH in 150 ml of absolute ether in the usual manner and refluxed for an additional hour. After cooling, a sample of the reaction mixture should give a positive Gilman-Shulze color test, indicating an excess of the hydride (this test is not necessary for you to perform). Hydrolysis was carried out with 400 ml of 20% aqueous sodium potassium tartrate and after separation of the layers, the aqueous portion is extracted with two additional 75 ml volumes of ether. Rectification yields 2.0 g of substituted phenylisopropylamine. JACS, 1837 (1952).

*Note:* According to Merck and Co., the potency of the hydroxy version of phenylisopropylamine is nearly as great as the non-hydroxy version, thus the above reduction may be omitted if you find the phenylisopropyl-hydroxylamine high enjoyable. Hydroxy methylenedioxyphenethylamine has been reported to be a very pleasant high.

### ***4-BROMO-2,5-DIMETHOXYPHENYLETHYLAMINE*** ***JCS, 200 (1953)***

This is another way to make the same drug in the above formula. The formula below is designed to take your already made speed and place the bromine atom in the proper place in the molecule. This particular formula is exemplified for phenylethylamine, which is about ten times weaker than phenylisopropylamine. The difference between the two is that phenylethylamine is made by using nitromethane as the nitrating agent and phenylisopropylamine is nitrated with nitroethane. Nitroethane is a lot more expensive and a lot more suspicious to the DEA when ordered, but it makes a more potent drug; you will find its synthesis in the precursor section. Both the nitrating agents are so alike, that they may be used in formulas as analogs (if you do not have nitroethane around you can substitute an equimolar amount of nitromethane and get a sym-

pathomimetic drug and vice versa). Likewise, drugs made from either of the nitrating agents are usually universally applied with success in any formula requiring one or the other, i.e., the formula that follows, the methylating, etc. The dose for the drug as made below (4-bromo-2,5-dimethoxyphenylethylamine) is about 5 mg and the dose for the drug as made above (4-bromo-2,5-dimethoxyamphetamine, sometimes called 4-bromo-2,5-dimethoxyphenylisopropylamine) is 0.5 (%) mg. The effects of the drug made either way are the same, MDA-like, only the dosage seems to change.

To a cooled solution of 3,4-dimethoxyphenylethylamine 5.4 g in 20 cc of acetic acid, 4.8 g of bromine in 15 cc of acetic acid is slowly added with stirring. Separation of the product will begin rapidly, and after setting overnight the crystals can be collected and recrystallized from ethanol. Addition of sodium hydroxide to an aqueous solution will precipitate the free base as white plates. Yield: 7 g, mp: 202-204°.

*Note:* The microfiche I got this formula from was so abused that I could not read the instructions for making the precursors. It may be interesting to see what effects this bromination will have on 3,4-methylenedioxyamphetamine and other ring substituted amphetamines.

## ***2,5-DIMETHOXY-4-METHYLAMPHETAMINE*** ***(DOM, STP) and ANALOGS*** ***JMC, 13, 134 (1970)***

This drug, known in laboratories as DOM and on the street as STP, is very potent and has one of the longest durations of action of any speed; a minimum dose to get you high (5 mg) will keep you high for at least 24 hours. If you are so brave as to do a nearly lethal dose, you may be unable to eat or sleep for a week or more. Thus the drug gained a bad reputation with some law officials and drug users. However, I feel that DOM represents a terrific value as it is easy to synthesize, it is inexpensive, it is powerful and it lasts a long time.

*2,5-Dimethoxy-4-methyl-B-nitrostyrene.* (This formula is exemplified for the analog of DOM and is three-fourths as powerful as DOM. If you prefer to make the actual DOM, then substitute nitroethane instead of nitromethane; this will produce nitropropene instead of nitrostyrene. Although nitromethane reduces potency slightly, its lower cost and non-suspicious availability makes it the better value for this particular formula.) Mix 5.4 g (30 mmoles) of 2,5-dimethoxy-p-tolualdehyde, 2.5 g of  $\text{NtOtOAc}$ , 25 ml of  $\text{CH}_3\text{NO}_2$ , and 25 ml of  $\text{C}_6\text{H}_6$ . Reflux for 20 hours, during which time the  $\text{H}_2\text{O}$  is azeotroped with a Dean-Stark tube. Cool and wash the resulting solution successively with two 25 ml  $\text{H}_2\text{O}$  portions, saturated solution of  $\text{NaHSOs}$  (two 25 ml portions), and two 25 ml portions of  $\text{H}_2\text{O}$ . The  $\text{C}_6\text{H}_6$  layer is dried with  $\text{NaSO}_4$  and evaporated in vacuo. Recrystallization from  $\text{CgHe-CyHie}$  (1:2 ratio) gives the product. Yield: 79% (5.3 g).

*2,5-Dimethoxy-4-methyl-B-phenethylamine.* To a stirred suspension of 3.0 g (80 mmoles) of  $\text{LiAlH}_4$  in 50 ml of THF (tetra-hydro-furan) is added a solution of 4.4 g (18 mmoles) of the above nitrostyrene (or nitropropene) in 50 ml of THF. Reflux for one hour, then cool this mixture in ice, and treat with a mixture of  $\text{H}_2\text{O}$  and THF to decompose the excess LAH. The resulting mixture is then filtered and the filter cake is extraaed with THF. The combined THF solution is evaporated in vacuo leaving 3.7 g of oily product. A solution of this oil in 25 ml of  $\text{Et}_2\text{O}$  is

treated with Et<sub>2</sub>O-HCl to precipitate 3.4 g (83%) of the hydrochloride salt, mp 200-203°. Recrystallization from EtOH gives the purified product Yield: 1.8 g, mp: 212-213°.

*Note:* Several other analogs of DOM are described but their potency is the same as mescaline and the starting material is the product above. I could not see changing a powerful drug in order to make a weaker drug, but if you would like to try these analogs then look up the reference above.

## **2,4-DIMETHOXY-5-ETHOXYPHENYLISOPROPYLAMINE** **JMC, 11, 188**

*1,3-Dimethoxy-4-ethoxybenzene.* To a solution of 4-ethoxy-3-methoxyphenol (14 g) in 20 ml of MeOH is added a solution of 5.3 g of KOH in MeOH (100 ml), followed by 11.9 g of Mel. The mixture is then refluxed for two hours, then quenched with 3 volumes of H<sub>2</sub>O, and made strongly basic with 5% NaOH. Extract with ether and evaporate the pooled extracts to get the title ether as a clear oil. Yield: 9.7 g.

*2,4-Dimethoxy-5-ethoxybenzaldehyde.* A mixture of N-methylol formamide 17.3 g in 19.6 g of POC<sub>1</sub><sub>3</sub> is allowed to stand for % hour at room temp. Then add 9.2 g of the above ether and heat this mixture for 2 hours on a steam bath. The resulting black viscous product is poured onto 800 ml of cracked ice and allowed to stand overnight. The crude aldehyde is removed by filtration and is recrystallized from 100 ml of MeOH. Yield: 8.8 g of fluffy white crystals.

*1-(2,4-Dimethoxy-5-ethoxyphenyl)-2-nitropropene.* A solution of the above benzaldehyde (6.7 g) in 25 g of AcOH is treated with 2.1 g of NH<sub>4</sub>OAc followed by 3.3 g of nitroethane (or analog). The mixture is then heated on a steam bath for 2 hours. After cooling, the addition of a small amount of water will cause the deposition of the product as a thick gel which is separated by recrystallization from toluene. Yield: 27%, mp: 97°.

*Note:* All compounds with a 5-ethoxy group are obtained in poor yields in this nitrating step, but this step can be used to nitrate other benzaldehydes with great success.

*2,4-Dimethoxy-5-ethoxyphenylisopropylamine.* This can be made by most any reduction. However, the reference given advises the use of the Soxhlet technique employed by Ramirez and Burger. Because of the importance and difficulty of reductions I have made a separate section on the subject; you can find the Soxhlet technique there along with many others.

## **SOME ANALOGS OF DOM (STP) CJC, 51, 1402(1973)**

Analog	Approximate potency
IE = 4-Bromo-2,5-dimethoxyamphetamine	ten times DOM
IF = 4-Chloro-2,5-dimethoxyamphetamine	equal to DOM
1H = 2,5-Dimethoxy-4-nitroamphetamine	equal to DOM
1G = 2,5-Dimethoxy-4-iodoamphetamine	not evaluated

As with most of these formulas, I will begin with the starting materials and work into the products. The reference that I have taken these formulas from has other formulas also, but I do



not feel they are important enough to be in this book. You may find them interesting in technique and use of reagents, though.

*2,5-Dimethoxyphenyl-nitropropene.* A solution of 10 g of 2,5 dimethoxybenzaldehyde, 4 g of ammonium acetate, and 6.8 g of nitroethane (or an equimolar amount of analog) in 50 ml of glacial acetic acid is heated on a boiling water bath for three hours, then the solvent is evaporated. The remaining residue is suspended in water and extracted with chloroform. Evaporation of the chloroform will leave the title compound. Crystallization from ethanol purifies. Yield: 11 g, mp: 73-75°.

*2,5-Dimethoxyamphetamine.* A solution of the above nitropropene (17.0 g) in 500 ml of dry ether is added slowly to a stirred solution of lithium aluminum hydride (LiAlH or LAH) 12 g suspended in 150 ml of dry ether. After completing the addition, the mixture is refluxed for 20 hours, then cooled. The excess LAH is decomposed by careful addition of water. The resulting suspension is filtered and the solid removed is washed with ether. The combined ether solutions are dried with MgSO<sub>4</sub>, and then saturated with dry hydrogen chloride. This precipitates the title compound which is filtered and recrystallized from ethanol. Yield: 13 g, mp: 111.5-112.5°.

*N-Acetyl-1-2,5-dimethoxyamphetamine.* 40 ml of acetic anhydride is added to a solution of 5 g of the above amphetamine and 25 g of sodium acetate in 300 ml of water. This mixture is to be shaken vigorously until the exothermic reaction stops. The resulting solution is then cooled, filtered and the filtrate recrystallized by ethanol to give the title compound. Yield: 4.2 g, mp: 104-105.5°.

*Note:* The last two steps give sympathomimetic substances as do all of the steps that follow. If the potency and effects of the DOM analogs are not important to you then you may stop after completing the second step (2,5-dimethoxyamphetamine).

*N-Acetyl-1-4-bromo-2,5-dimethoxyamphetamine.* A slight excess of bromine water is added to a solution of 3.0 g of the above drug (N-acetyl-1-2,5-dimethoxyamphetamine) in 30 ml of dioxane, and the solution is stirred for 6 hours. The solvent is removed by evaporation, leaving the title compound, which is recrystallized from ethanol. Yield: 3.0 g, mp: 153-155°.

(A) *IE 4-Bromo-2,5-dimethoxyamphetamine Hydrochloride.* A suspension of N-acetyl-1-4-bromo-2,5-dimethoxyamphetamine (2.5 g) in 60 ml of hydrochloric acid and 60 ml of water is heated at reflux temperature for 18 hours during which time the N-acetyl compound will dissolve. Unreacted starting material can be removed and the filtrate evaporated to give a yellow solid that is recrystallized from ethanol-ether to give the product as clear solid. Yield: 1.7 g, mp: 195-196°. (This is method A, below is method B, which is a different way to get the same product. These methods will be used again and again to get the hydrochlorides to some of the other DOM analogs.)

(B) *IE 4-Bromo-2,5-dimethoxyamphetamine Hydrochloride.* (This is method B.) 1.5 g of N-acetyl-1-4-bromo-2,5-dimethoxyamphetamine is added to a solution of sodium hydroxide (5.0 g) in 25 ml of water and 50 ml of ethylene glycol. This mixture is then heated under reflux for 15 hours and cooled. The solution is extracted with chloroform and the combined extracts are evaporated. The remaining solid is dissolved in 5% hydrochloric acid (15 ml) and filtered. The title compound is obtained after crystallization with ethanol-ether. Yield: 0.85 g, mp: 197-198°.

*N-Acetyl-1-2,5-2,5-dimethoxy-4-nitrophenylisopropylamine.* A solution of 50 ml of 70% nitric acid in 400 ml of water is added to a solution of N-acetyl-2,5-dimethoxyamphetamine (40 g) and 0.5 g of sodium nitrite in 400 ml of glacial acetic acid. This solution is stirred for 4 hours,

then cooled and diluted with 400 ml of water. The title compound precipitated and is recrystallized from ethanol. Yield: 42.1 g, mp: 166-168°.

(Iff) *2,5-dimethoxy-4-nitrophenylisopropylamine hydrochloride*. Hydrolysis of N-acetyl-2,5-dimethoxy-4-nitrophenylisopropylamine (2.0 g) using the procedure of IE method B gives the title compound when recrystallized from ethanol-ether. Yield: 0.76 g, mp: 203-204°.

*N-Acetyl-4-amino-2,5-dimethoxyamphetamine Hydrochloride*. A solution of 39 g of N-acetyl-2,5-dimethoxy-4-nitrophenylisopropylamine in ethanol is hydrogenated over 10% palladium-charcoal (1.0 g) until the theoretical amount of hydrogen is absorbed (3 days). The catalyst is removed and the filtrate evaporated. The residue is suspended in 5% sodium hydroxide solution (100 ml) and extracted with chloroform (3 times 100 ml). The combined chloroform extracts are evaporated and the remaining solid is dissolved in dry ether. When dry hydrogen chloride is passed through this solution, the title compound precipitates and is recrystallized from ethanol-ether. Yield: 31.5 g, mp: 237-239°.

*N-Acetyl-4-chloro-2,5-dimethoxyamphetamine*. A solution of 5g of N-acetyl-4-amino-2,5-dimethoxyamphetamine hydrochloride in 15 ml of hydrochloric acid and 30 ml of water is cooled to 0°, To this stirred and cooled solution, 1.4 g of sodium nitrite in 10 ml of water is added. This cooled solution of diazonium salt is then added slowly to a solution of 2.5 g of cuprous chloride in 9 ml of hydrochloric acid. This reaction mixture is allowed to come to room temp, then is heated to 70° and cooled, and recrystallized from ethanol to give the title compound. Yield: 2.8g, mp: 150-152°.

*N-Acetyl-2,5-dimethoxy-4-iodophenylisopropylamine*. 5 g of the diazonium salt is prepared as described immediately above and cooled to 0° then added gradually to a solution of 8 g of potassium iodide in 10 ml of water. After reaching room temp the reaction is set until the evolution of nitrogen has stopped. The dark brown viscous semi-solid that will separate is dissolved in ethanol with heat and then cooled. On cooling the title material separates out and is crystallized from ethanol. Yield: 1.97 g, mp: 167-168°.

(IF) *4-Chloro-2,5-dimethoxyamphetamine Hydrochloride*. The title compound is obtained when N-acetyl-4-chloro-2,5-dimethoxyamphetamine (1.5 g) is treated as described for the synthesis of compound IE, method B. Yield: 0.46 g, mp: 193-194.5°.

(1G) *2,5-dimethoxy-4-iodophenylisopropylamine Hydrochloride*. The title compound is obtained from 1.5 g of N-acetyl-2,5-dimethoxy-4-iodophenylisopropylamine using method B procedure for compound IE. Yield: 0.75 g, mp: 198-200°.

## MESCALINE

### JOURNAL OF CHEMISTRY U.A.R. 11, 401 (1968)

Reflux 100 g of 3,4,5-trimethoxybenzoic acid (this can be synthesized, Organic Synthesis Collection vol 1, 537 (1946), but it is almost cheaper to buy than to make and it is not that easy to make given the low purchase price) with concentrated sulfuric acid in ethanol for 2 to 3 hours. Cool, filter, recrystallize with ethanol to get the ester. Another method to get the ester is as follows: Add, while stirring, over 20 min, 94 g of methyl or ethyl sulfate to 100 g of 3,4,5-trimethoxybenzoic acid, 20 g NaOH, 55 g NaHCO<sub>3</sub>, in 300 ml of water, and reflux Vi hour. Cool, filter, and dissolve this filtered substance in ethanol by heating and cool to precipitate. Filter this precipitate and acidify the filtrate to recover the unreacted 3,4,5-trimethoxybenzoic acid.

Dissolve 1 mole of the above ester and 10 moles of  $\text{NaBH}_4$  in methanol and reflux for four hours. Cool, filter, dry, and evaporate in vacuo to get 3,4,5-trimethoxybenzyl alcohol

To a stirred and cooled (to  $0^\circ$ ) solution of 39.5 g of the above trimethoxybenzyl alcohol (or analog) in 250 ml of methanol, add carefully 54 ml of  $\text{Br}_2$  over one hour keeping the temp at  $0^\circ$ . Still stirring, allow temp to rise for 2 hours to  $70^\circ$  F. Stir for 2 hours and add 30 ml of saturated sodium thiosulfate. Filter off the aldehyde and recrystallize with benzene.

I have described a very good way to nitrate benzaldehydes in the first formula for 4-bromo-2,5-dimethoxyamphetamine, JOC, 18, 1 (1953). This can be used for the next step or you may use the following nitration step given below.

To a solution of 40.5 g of the above aldehyde and 16 g of nitromethane (for mescaline) or an equimolar amount of nitroethane (for phenylisopropylamines) in 100 ml of ethanol, add 14 ml of 3% methylamine in methanol, in nitrogen atmosphere if possible. Let stand at room temp for one day, then cool to  $-10^\circ$ , filter, wash with cold methanol, and evaporate the solvent in vacuo to get the nitrostyrene or nitropropene.

Reduce to the active amine by using any of the reduction steps given so far or by any of the steps in the reductions section.

## **METHYLENEDIOXY COMPOUNDS**

These compounds are analogs of the trimethoxy type compounds. They produce a pleasant, euphoric trip, much like a cross between mescaline and crank. The starting material (benzene ring) makes considerable difference in the potency of the final product of this or any other amphetamine. Below is a list of benzenes and their potency in M.U. (mescaline units). Also, the modification to the ring can create, more or less, a psychedelic effect.

Allyl benzene	Propenyl benzene	M.U.
Myristicin	Isomyristicin	3 to 2
Safrole	Isosafrole	3 to 2
Dillapiole	Isodillapiole	5
	Acetone	12 to 20
Apiole	Isoapiole	10 to 12

### **3-Methoxy-4,5-Methylenedioxyphenyl-Nitropropene. MMDA CJC, 46, 76 (1968)**

(You may use any of the above propenyl benzenes in this formula, but to get the maximum yield, compute the equimolar amount.)

A solution of 50 g of isomyristicin (or analog) in 300 ml of dry acetone and 24 g of pyridine is cooled to  $0^\circ$  with vigorous stirring. Then add 54 g of cold tetranitromethane (slow), which will cause a slight temp rise of about  $5^\circ$  despite your external cooling. Quench this mixture, after stirring for a few more min, with 16.8 g in 300 ml of water. The stirring is continued until the

temp gets back down towards 0°, then the product is removed by filtration and recrystallized from methanol. Yield: 50 g, mp: 110°. Reduce by any method in reduction section.

This is a fast easy method. If you have a battery powered stirring device it can be performed most anywhere. If you wish to do this formula on a smaller scale then use the following formula. As tetranitromethane is expensive, I suggest you practice on the small scale first. Nitropropenes or nitrostyrenes are *not* psychoactive, you need to find a reduction.

### **MDA, JMC, 9, 445 (1966)**

A solution of 6.5 g of isosafrole (or analog), 3.3 g of pyridine in 41 g of dry acetone is cooled to 0°, Add 6.9 g of cold tetranitromethane over one min with good stirring. Stir for 2 more min and quench as above with 2.2 g of KOH in 40 ml of water, add a little more water and extract the nitropropene with dichloromethane. Evaporate after drying and recrystallize from methanol. This extracting with dichloromethane should be used in the above formula to get an additional amount of product from the filtrate. Follow the instructions immediately above. Dichloromethane is the same as methylene chloride.

*Caution:* Tetranitromethane is nasty stuff, it explodes on contact with most any impurity, and is toxic and corrosive. For these reasons it cannot be shipped UPS; it must be trucked and the shipping will cost a minimum of \$50. Even if you order 1 g you pay \$50 shipping, so if you are going to order some you may as well get as much as you can possibly afford. It is possible to have a university or analytical lab make some for you, but the cost of these little outfits may overcome the high shipping costs from the major suppliers. Expect to pay \$35 for 5 g from the major suppliers. If you live close enough to the big suppliers to pick it up in person, you are lucky; if you have an accident on the way home with 50 g of the stuff in your car, you may be very unlucky.

This next formula is easy, and although I have never seen the effects or potency on humans, I believe that it would be at least as powerful as DOM, due to the substituted bromine atom. As in most formulas, using nitromethane produces a product 10 times weaker than nitroethane; use the one that suits you best.

### **3-Bromo-4,5-Methylenedioxy-B-Phenethylamine. CPB, 16, 217 (1968)**

*3-Bromo-4,5-methylenedioxy-B-nitrostyrene.* A solution of 64 g bromopiperonal, 65 g nitromethane (or analog), and 30 g of NH<sub>4</sub>OAc in 400 ml of AcOH, is heated to reflux for 2 hours. Cool and pour the mixture into 1 liter of water. This will precipitate a crystal solid that is removed by filtration and recrystallized from CHCl<sub>3</sub>-EtOH (50% by volume) to give the product. Yield: 55 g, mp: 160-161°.

To reduce to the active formula, see the zinc reduction as given in the reduction section, CPB, 16, 217 (1968). This reduction is specifically matched to 3-bromo-4,5-methylenedioxy-B-nitrostyrene and other highly substituted ring type styrenes and propenes. Zinc reductions carried out properly are very gentle and do not destroy delicate ring substituents, while some reductions do. Zinc reductions can reduce any nitrostyrene or propenes, but some of these compounds *must* use the zinc reduction. Which compounds? Compounds with lots of ring substituents, like 2,5-dimethoxymethylenedioxy, 3-methoxy-4-O-carbomethoxy, etc. This is not to say that some of the other reductions are not capable of gentle reductions.

### **Another Methylenedioxyamphetamine Type Formula CA, 52 (1965)**

(This is exemplified for MDA; however, it may be replaced with any equimolar amount of any of the above propenylbenzenes to create the desired potency and effect, for instance, replacing

isosafole with isomyristicin gives MDMA instead of MDA. Also, replacing formamide with N-methyl-formamide in this formula will give N-methyl-MDA which is claimed to be more pleasant.)

*3,4-Methylenedioxyphenylisopropylamine.* To a cooled (I would guess around 30°) mixture of 34 g of 30% H<sub>2</sub>O<sub>2</sub> and 150 g of formic acid, is dropped (added slowly, dropwise) a mixture of 32.4 g of isosafole and 120 cc of acetone (the safole mix is dropped into the H<sub>2</sub>O<sub>2</sub> mix) never letting the temp rise above 40°. Let mixture stand overnight and then evaporate in vacuo. Add 60 cc of MeOH and 360 g of 15% H<sub>2</sub>SO<sub>4</sub> and heat on water bath for 3 hours, cool, extract with ether or C<sub>6</sub>H<sub>6</sub>. Distill the extract in vacuo to afford 20.6 g of 3,4-methylenedioxybenzylmethyl ketone. Collect the liquid coming over at 108° to 120° when vacuum distilling above.

(The above ketone can be reduced by most any method of hydrogenation, e.g., JACS, 70,1315 (1948), for benzyl methyl ketones, or use the method given with the formula which is given below, CA, 52, 11965(1958).

23 g of the above ketone is added to 65 g HCONH<sub>2</sub> and heated at 190° for 5 hours. Cool the mixture, add 100 cc of 30% H<sub>2</sub>O<sub>2</sub>, and extract with C<sub>6</sub>H<sub>6</sub>. Evaporate the extract, add 8 cc of MeOH and 75 cc of 15% HCl to dried extract and heat on a water bath for 2 hours. Extract with benzene, make alkaline (with caustic alkali or KOH or NH<sub>4</sub>OH), and vacuum distill (collect the fraction coming over at 122-127°) to afford 11.7 g of 3,4-methylenedioxyamphetamine. To turn this into the hydrochloride form (amphetamines are active in either form, but hydrochloride is more convenient to handle, measure, and snort) follow the instructions of method A or B, for the drug IE, from the above reference CJC, 51, 1402 (1973). (See page 44 of this book.) The title is, Some Analogs of DOM.

*N-a-Phenethylamine* JACS, 91, 5647 & 5648 (1969)

This simple, convenient procedure eliminates the use of strong acids which sometimes cause unwanted molecular rearrangements and the isolation and handling of toxic organomercuric halides. It also allows you to apply the borohydride reduction directly to the adduct, without precipitating it as the chloride. The main precursor is any allyl benzene eliminating the need for conversion to a propenyl benzene.

*N-acetyl-phenethylamine.* Place 100 ml of acetonitrile and 64.8 g (.2 mole) of mercuric nitrate in a flask with stirring and cool to 25°. To this externally cooled and stirred mixture add 0.2 mole of allyl benzene at such a slow rate as to keep the temp under 30°. After the addition, stir at room temp for 1 hour, cool again, and achieve the reduction by adding 200 ml of 3 M sodium hydroxide, followed by 200 ml of .5 M sodium borohydrate in 3 M sodium hydroxide. After 1 hour the water layer is saturated with sodium chloride and the product taken up with (extracted with) ether. Distillation, collect the fraction coming over at 101-105°. Yields: 20 g of product.

*Tyramine (p-Hydroxy-Phenylethylamine)* JACS, 55, 3388 (1933)

Tyramine is derived by using 4-hydroxybenzaldehyde as the starting material. Vanillin and o-vanillin can also be used in this synthesis to make the tyramine analogs 2-hydroxy-3-methoxy-B-phenylethylamine and 3-methoxy-4-hydroxy-B-phenylethylamine, respectively. Vanillin is less suspicious to purchase and the potency and effects of the vanillin made drug are about the same as Tyramine.

*Hydroxymandelonitriles.* One mole of the aldehyde (vanillin, etc.), usually about 15 g, is dissolved in a solution of sodium metabisulfite (2 moles) in 100 cc of water. Heat this solution to 50°, then cool to 0°. Hold the temp here and with good stirring, add 4 moles of a saturated,

aqueous solution of potassium cyanide over the proper time allowed for the aldehyde used. For the 4-hydroxybenzaldehyde, make the potassium cyanide addition over one hour. For vanillin, the addition is 20 min, and for o-vanillin, make the addition as fast as possible without creating excessive temperatures (a few min). Extract the reaction mixture with ether and wash the ether with sodium metabisulfite solution. Dry over calcium chloride and partly evaporate. Add benzene seed and/or scratch, and refrigerate to crystallize. Recrystallize from petroleum ether with a small amount of benzene added. Yield: 55%.

*Tyramine.* Reduce as described (JACS, 55, 2593-4) in the reductions section and be sure to use the one labeled JACS, 55, 2593-4 to get Tyramine or analog. This reduction was specifically designed to reduce without destroying the ring substituents. It is also essential to purify the mandelonitrile very completely before attempting the reduction.

### **A Different Method of Producing Tyramine Analogs JACS, 72, 2781**

This first synthesis is easy, cheap and produces large amounts of easy to reduce nitrostyrenes.

*4-Hydroxy-3-methoxy-B-nitrostyrene.* A mixture of methylamine hydrochloride (7 g, see precursor section for synthesis) and 10 g of sodium carbonate in 100 ml of methanol is stirred well, filtered, and added to a solution of 219 g of vanillin and 85 ml of nitromethane in 600 ml of ethanol. Keep this solution in the dark at room temp for 71 hours to make the nitrostyrene crystallize out. Filter and wash with cold methanol. Yield: 225 grams, mp: 166-168°. This and the other two nitriles are reduced by the method listed in the reduction section, JACS, 72, 2781. This reduction can be used to reduce many of the nitro type compounds.

*3-Hydroxy-4-methoxy-B-nitrostyrene.* This compound is prepared from 3 g of isovanillin and 1.2 ml of nitromethane by using the same method as above, and letting sit for 50 hours. It is reduced as above using 1.3 g of nitrostyrene added over a period of 6 hours to 1.1 g of LAH in 150ml of ether.

*2-Hydroxy-B-methoxy-B-nitrostyrene.* A solution of freshly distilled 2-hydroxy-3-methoxybenzaldehyde (5g), 2.5 ml of nitromethane and 2 g of ammonium acetate in 20 ml of glacial acetic acid is refluxed for two hours. Cool and pour the dark brown mixture into water and allow the gummy product to crystallize. Recrystallize from benzene with the acid of Norit. Yield: 2.3 grams of yellow needles melting at 115-122°. This is also to be reduced to an active compound as described in JACS, 72, 2781.

*Tyramine From Tyrosine.* This is so easy that it is scary, and is probably the reason that tyrosine is watched very closely by the DEA. To avoid exposure to the DEA you may use the formula in the precursors section of this book. It is fairly simple to make. Also, your local health food store, Co-Op or livestock feed supplier may have tyrosine, as it is an important amino acid that is used sometimes as a feed supplement. These farm type suppliers that I have come to know do not report sales of tyrosine to the DEA. Maybe, in your part of the nation, they do.

To decarboxylate tyrosine into tyramine, heat the tyrosine with barium hydroxide and separate, as seems practical (several ways are possible) to you. It will be easy to understand once you perform this operation, as it is really quite self-explanatory. Purify as described in JACS, 72, 2781 in the reductions chapter.

# HALLUCINOGENS

## LYSERGIC ACID DIETHYLAMIDE

LSD is, without a doubt, the king of hallucinogens. It is rather difficult to make by total synthesis, but with the right starting materials (lysergic acid, ergotamine) it is as easy to produce as your average THC or amphetamine. I call it the king because of the awesome potency, the usual hallucinogenic dose being about 100 to 400 micrograms orally. The amphetamine DOM (STP), which is 100 times more powerful than mescaline, requires a dose of 5 milligrams. This gives one gram of LSD the potential to contain 4,000 to 10,000 doses. With an average of about 6,000 doses per gram, the street value (based on \$5 a hit) of one gram of LSD is \$30,000.

LSD gets its potency from the combination of units within its molecular makeup. Both the indole ethylamine and the phenylethylamine units reside within its structure.

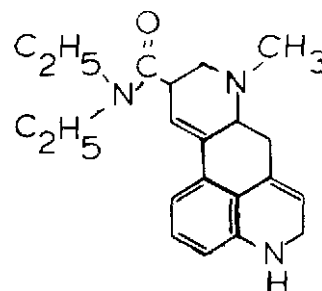

### LSD Synthesis

As with the rest of this book, I will deal only with the synthetic manufacture of drugs (LSD included). If you want to grow the ergot alkaloids that begin the total synthesis of LSD, then you will have to go to the *Merck Index* and look up the references to the operation, Michael V. Smith's book, *Psychedelic Chemistry*, has a section on growing *Claviceps purpurea*, which yield ergot compounds. This section is very complete and informative, but I think that you should also look up the dangers of growing this fungus before doing it, as it causes a type of gangrene that can kill you (not to mention making your arms and legs fall off) upon contamination of your body. As Mr. Smith's book states, this fungus is very temperamental, hard to obtain, even harder to grow and difficult to work with. Smith's book gives many references and many formulas that you will not see here, but which are of great interest in the making of all hallucinogens (not just LSD). This does not make my book incomplete. On the contrary, I have given more than enough information to make every major type of drug.

My book is not intended to cut in on Smith's book sales. It is intended to give you information and formulas that Smith's book lacks. Where he gives many different types of formulas, I give only the fast, simple and high yielding formulas. Also, you will not see the same formula in both his and my book, unless it is a general method and not specific. What his book lacks, my book gives (equipment, methods, basic chemistry, a wider variety of types of different classes of drugs,

glossary terms, easier to understand wordage, how to buy and make precursors, etc.). What my book lacks, his book gives (more variety of hallucinogenic formulas, cultivation of pot and ergot, tests for activity, etc.). I feel it would be a good idea to buy his book and try some of these harder formulas after learning the basics and practicing some of the formulas from my book, for complete understanding first.

Forgive me for wandering from the subject of LSD synthesis. As this first chapter of formulas is for psychedelics, I felt it necessary to explain the difference of the only other book of this type.

### **LSD From Lysergic Acid**

If you are sharp, and have carefully read my chapter on buying precursors, you should be able to get lysergic acid from a supplier. Be warned, that the DEA must be informed of the purchase by the supplier, according to laws requiring them to do so. Lysergic acid can be made. Following is the general method to give you a very good idea of the procedure and chemicals involved.

*Synthesis of Lysergic Acid*, By reacting N-benzoyl-3-(B-carboxyethyl)-dihydroindole (see JCS, 3158 (1931) for the preparation of this compound) with thionyl chloride, followed by aluminum chloride gives 1-benzoyl-5-keto-1,2,2a,3,4,5-hexahydrobenzindole. This is then brominated to give the 4-bromo-derivative, which is converted to the ketol-ketone by reacting with methylamine acetone ethylene ketol. This is then hydrolyzed by acid to yield the diketone and treated with sodium methoxide to convert it to the tetracyclic ketone. Acetylate and reduce this ketone with sodium borohydride to get the alcohol, which is converted to the hydrochloride form, as usual.

The above hydrochloride is treated with thionyl chloride in liquid sulfur dioxide, to produce an amorphous chloride hydro chloride, which is converted to the nitrile with sodium cyanide in liquid hydrogen cyanide, Methanolysis then gives the ester of the nitrile. Alkaline hydrolysis of this last compound, followed by catalytic dehydrogenation in water using a deactivated Raney Nickle catalyst (see JOC, 13, 455 1948) gives dl-lysergic acid.

### **Total Synthesis Of Lysergic Acid**

This is the easiest way to totally synthesize lysergic acid. There are other ways, but after reviewing other methods, I found this to be superior. It is quite complicated and it takes good modern equipment.

*JACS*, 78, 3087 (1956). 3-Indolepropionic acid, 94.5 g (0.5 mole) is dissolved in 600 ml of water containing 20 g of NaOH. The solution is mixed with 100 g of Raney Nickle catalyst and hydrogenated at room temp in a steel bomb at about 3,500 psi until the uptake of hydrogen stops (about 20-30 hours). Filter off the catalyst and wash it with a little water to remove the product that is clinging to it. Add 85 ml of coned HCl acid to the filtrate, and cool. If your reduction is incomplete, you will now have unreacted starting material separate, and this must be removed by filtration. Benzoylate the filtrate (the Schotten and Baumann method is preferable), using 210 ml of 12 N NaOH 180 ml of benzoyl chloride. Keep the solution alkaline throughout the benzoylation, and keep the temp below 40° by cooling. When the benzoyl chloride is fully reacted, the reaction mixture is cooled and acidified with 300 ml of HCl acid. Filter the crude product by filtration, wash with water, and extract with four 1 liter portions of hot water. Separate, and crystallize the resulting syrupy product from a few volumes of methanol. Filter and wash with a little cold methanol to get a little over 100 g that melts at 151-153°. This is 1-Benzoyl-3-beta-carboxyethyl-2,3-dihydroindole. This can be purchased to eliminate this step.



*l-Benzoyl-5-keto-1,2,2a,3,4,5,-hexahydrobenzindole.* 118 g of the above product (1-benzoyl-3-B-carboxyethyl-2,3-dihydroindole) is mixed with 200 ml of pure thionyl chloride. This solution is allowed to stand for 30 min, then it is warmed gently for 15-21 min on a steam bath. Excess thionyl chloride is completely evaporated with the temp maintained between 22-26° in vacuo. The crude acid chloride is dissolved in dry carbon disulfate. This solution is added, in a thin stream, to a well stirred suspension of 240 g of aluminum chloride in 1750 ml of carbon disulfate in a 5,000 cc flask. *Note:* this must be done under a fume hood. A complex will separate and bog down the stirring device. **Heat** this mixture under reflux with stirring for 1 hour. Decompose this mixture by adding 500 g of ice, 250 ml of coned HCl acid, and 500 ml of water, all while good stirring is continued. Cooling of this operation is affected by periodic distillation of the carbon disulfate in vacuo. After the decomposition is complete, any remaining carbon disulfate is removed completely in vacuo, and the product is extracted with 2 liters of benzene. The extract is washed well with 500 ml of 2 N NaOH in three portions, and then with water. Dry (with the usual magnesium sulfate), and evaporate to a small volume in vacuo. Add this small volume to several portions of ether to get the ketone to crystallize (add slowly), and filter, then wash with ether to get 85 g of pure title product, mp: 146-147°.

*l-Benzoyl-4-bromo-5-keto-1,2,2a,3,4,5-hexahydrobenzindole.* A solution of the above indole (305 g) in 2,200 ml of glacial acetic acid is warmed to 40°. While the reaction is illuminated with a 250 watt bulb, 352 g of pyridine hydrobromide perbromide is added in portions, over 5 min with shaking. The solution is then heated to 60° and is held between there and 55° for 30 min. Treat the mixture with carbon, and evaporate to a small volume in vacuo. The residue is taken up with 2,200 ml of chloroform, and wash this solution with several portions of water, dry as above, and concentrate in vacuo. Crystallize the residue from 2,200 ml of 50% acetic acid and 50% ether to get 270 g of title product that melts at 180.5-181.5°. Another crop can be obtained from concentrating the filtrates. Yield: 30 g of less pure product.

*l-Benzoyl-2,3,4-tetrahydro-4-methyl-2-methyl-1,3-dioxolan-2-yl-methyl-aminobenzindol-5-(IH)one.* A solution of the last indole product above (270 g) and 307 g of methylaminoacetone ethylene ketol in 4,500 ml of dry benzene is refluxed for 21 hours under a slow stream of nitrogen. The mixture is cooled and 151 g of methylaminoacetone ethylene ketol hydrobromide is filtered off. The filtrate is washed with ice water, then extracted with 2.5 liters of cold dilute HCl acid containing 150 ml of the coned acid. The acid extracts are immediately added to an excess of ice cold dilute NaOH. Extract with 1 liter of chloroform, dry over magnesium sulfate, treat with carbon and concentrate by evaporation in vacuo. The residual ketol-ketone is crystallized from acetone to yield 220 g, mp: 135-136°.

*5-Keto-4-N-methyl-N-acetyl-amino-1,2,2a,3,4,5-hexahydrobenzindole.* 20 g of the above product is dissolved in a mixture of 250 ml of coned HCl acid and 250 ml of water, and the solution is kept under nitrogen for 5 days at 37°. Cool the mixture, treat with carbon, filter, and concentrate the filtrate in vacuo to a small volume. Treat the residue with an excess of sodium bicarbonate, extract with cold chloroform, and remove the chloroform by evaporation in vacuo at room temp. The crude diketone is powdered, slurried with 75 ml of *Vi* benzene-1/4 ether, and filtered. Yield: 9.8 g, mp: 105-107°.

*9-keto-7-methyl-4,5,5a,6,6a,7,8,9-octahydroindolo-(4,3)isoquinotine.* 25 g of the above product is mixed with 550 ml of absolute ethanol. Stir this mixture under nitrogen and cool to -15° with an external freezing mixture. Sodium methoxide is added (17 g) and the mixture is stirred for 10 min at -10 to -12°. Cool to -25°, and the product is filtered and washed (while still in the funnel) with cold ethanol and ether. Without exposure to air the crude ketone is immediately

slurried with a little ice water and filtered. Wash with ice water, ethanol, then ether (all cold) to yield 16 g of product melting at 145-147°.

*4-Acetyl-9-keto-7-methyl-4,5,5a,6,6a,7,8,9-octahydroindolo-4,3-quinoline.* 24 g of the last product is added to 80 ml of cold acetic anhydride. The mixture is held at 25° for about 5 min, then thoroughly cooled, filtered, and the product (a solid) washed with ether to yield 20.5 g, mp: 169-170°. A second crop is obtained by concentrating the mother liquor by evaporation.

A mixture of the last product (1.0 g) and 10 g of palladium carbon (5%), in 35 ml of xylene, is heated under reflux for 4 hours. The catalyst is filtered and extracted with hot methanol and chloroform. The combined extract filtrates and the initial filtrate are combined and evaporated in vacuo. The residue is recrystallized from water to give 0.6 g of a monohydrate product that melts at 255-256°. This product is called 4-acetyl-4,5,5a,6-tetrahydro-9-hydroxy-7-methylindolo-(4,3fg)-quinolinium hydroxide betaine.

*4-Acetyl-9-hydroxy-7-methyl-4,5,5a,6J,8,9JQ-octahydroindolo-(4,3fg)-quinoline.* 1 g of the above betaine in a mixture of 20 ml of ethanol and 5 ml of water, is treated with 0.08 g of sodium borohydride, and this solution is refluxed for 10 min and kept at 25° for 1 hour after the reflux is finished. The solvent is distilled off, and the residue is taken up in a mixture of chloroform and water. The chloroform solution is separated, dried as above, and then the solvent is distilled off. The residue is recrystallized from a nitromethane-ethyl acetate mixture to yield 0.2 g (21%), mp 193-196°. Not only is this a small scale, but it is a poor yield, requiring you to perform it several times to get enough product to perform the next step. When you have more than enough, convert the product into its hydrochloride form by dissolving in dry methanol and precipitating with dry hydrogen chloride.

*4-acetyl-9-chloro-7-methyl-4,5,5a,6,6a,7,8,9-octahydroindolo-(4,3fg)-quinoline hydrochloride.* 3.1 g of the above product in its hydrochloride form is dissolved in 75 ml of liquid sulfur dioxide contained in a glass lined, high pressure bomb, or autoclave. Thionyl chloride (1.2 ml) is added and the vessel is sealed and kept at 25° for 6 hours. Vent the vessel carefully and remove the mixture. Evaporate the sulfur dioxide while keeping the volume of the solution constant by the slow addition of dry ether. The amorphous chloro hydrochloride is filtered, washed with ether (dry) and dried by evaporating in vacuo to give 3.5 g of product, mp: 130-135°.

*4-Acetyl-9-cyano-7-methyl-4,5,5a,6,6a,7,8,9-octahydroindolo-(4,3fg)-quinoline.* 40 g of dry, powdered sodium cyanide, is added to ice cold liquid hydrogen cyanide and stirred gently with ice bath cooling. Speed up the stirring, continue the cooling, and add 7.5 g of the amorphous product directly above. Continue stirring for 30 min, then the hydrogen cyanide is distilled under enough reduced pressure to keep it coming over the condenser at a temp below 10-12°. The residue is mixed with chloroform and ice water, and the resulting mixture is filtered. The organic layer of the filtrate is separated and the aqueous layer is extracted with two separate portions of chloroform. The combined extracts (this would include the separated chloroform, as usual) are dried over magnesium sulfate, decolorized, and the solvent removed by distillation in vacuo. Crystallize the product in ethyl acetate. Yield: 3.3 g, mp: 173-174°. Recrystallize again for extra purity.

*9-Carbomethoxy-7-methyl-4,5,5a,6,6a,7,8,9-octahydroindolo-(4,3fg)-quinoline.* 1 g of the last product is mixed with 15 ml of methanol and 0.25 ml of water. With external (ice bath) cooling add 2 ml of coned sulfuric acid slowly. Seal this solution in a high pressure bomb with a glass liner (or in a glass tube taking safety precautions in case of explosion) with a nitrogen atmosphere, and heat at 100° for 23-24 hours. *Note:* I have seen a big pressure cooker (like gramma cans

peas with) work for some of these bomb procedures. I do not recommend it, but here is how to do it right, if you feel you must. Use only the great big heavy duty models, in excellent condition, set the pop off (relief valve) for near maximum position; never, ever tamper or modify this valve to get more pressure. Put the product in a glass beaker, put it in the cooker, flush with nitrogen, heat and stay in a different house during the reaction. Carefully turn off heat, notice or record pressure gauge after time has elapsed. Wait until pressure drops noticeably, bleed off remaining pressure and get product.

Treat the mixture with decolorizing carbon and then evaporate in vacuo to 10 ml. Pour onto a mixture of 30 ml of chloroform, ice, and 10 g of sodium bicarbonate. Separate the chloroform layer, and extract the aqueous phase with three 10 ml portions of chloroform. The combined chloroforms are dried, evaporated to dryness in vacuo, and the product is crystallized from benzene to give & g of product that melts at 159-160°. You may purify more by recrystallizing from ethyl acetate. This is not very much product. As with the procedure 4 steps back, you will have to perform this step over and over. If you try to double or triple the amounts given, you may get more product, but you will hurt the yield.

*dl-Lysergic acid.* 3.9 g of the last product is mixed with 78 ml of 1.5% potassium hydroxide solution. Reflux for 30 min under nitrogen. 8.5 g of hydrogen sodium arsonate, and Raney Nickle (16 g wet), that has previously been deactivated by boiling in xylene suspension (see JOC, 455 (1948) to deactivate), is added and the mixture is refluxed and stirred under a nitrogen atmosphere for 20 hours. The solution is treated with carbon, and the crude lysergic acid is precipitated by neutralization to pH 5.6, and then filter it off and wash with water. Yield; 1.04 g. A second crop is obtained in the usual manner (0.15 g). Purify by dissolving in dilute ammonium hydroxide, treat with decolorizing carbon, and reprecipitate with carbon dioxide to get a mp of 242-243°. You may be able to get an analytical or laboratory consultant to make one of these products near the final step, thereby eliminating the need to go through all of the steps as described. This will save you much time, but as these people are highly trained, their time will be costly.

Lysergic acid can be made from many ergot derivatives by hydrolysis of these compounds. These compounds include ergonovine, ergotamine, ergokryptine, ergosine, methysergide, ergine, and a few others. Total synthesis of these compounds is impractical, as lysergic acid is made before the alkaloid. You could stop the operation as soon as you reach lysergic acid, otherwise you will have to hydrolyze as described below. There are many analogs of these alkaloids that end with the ine suffix. These are not as suspicious as the former because they lead to an inactive iso-LSD. They will look like this: the ergotamine isomer = ergotaminine, the ergonovine isomer = ergonovinine, etc. These analogs are easily converted to the active forms or they may be used exactly as the non-iso versions to give the iso-LSD, which is converted very easily to LSD as also described below.

### **Lysergic Acid From Ergot Alkaloids.**

Dissolve 20 g of the alkaloid (use any of the above or one of its isomers or a combination) in 200 ml of 1 M methanolic KOH solution (this is made by dissolving 14 g of KOH in 250 ml of dry methanol) in a 1 liter evaporation flask (heavy walled construction). Evaporate the methanol off. Add 400 ml of 8% aqueous (water) KOH solution to the residue and boil for one hour under a slow stream of nitrogen that is allowed to flow through a small orifice for exhausting purposes. Cool, acidify with dilute sulfuric acid, and shake in a separatory funnel with 1 liter of dry ether. Separate the lower aqueous layer and filter it with vacuum assist. Wash the precipitate with 20 ml of dilute sulfuric acid. This is lysergic acid; store as described later in this chapter.

There remains a small amount of lysergic acid in the filtrate solution. Remove it by basifying the solution with sodium carbonate, and then bubbling CO<sub>2</sub> through it. Filter it off and add it to the other lysergic acid. Now you will need to precipitate the iso-lysergic acid out and convert it. If you did not use any iso-alkaloid then you will have very little iso-lysergic acid, but it is still worth converting. If you used iso-alkaloid, this is a must.

Precipitate the iso-lysergic acid by adding some 10% HNO<sub>3</sub>, filter, add more portions until no more precipitate forms. Convert it to lysergic acid by adding 3 ml of 10% KOH per every 0.1 g of iso-lysergic acid, heat on steam bath for 1 hour under a nitrogen atmosphere. Precipitate the changed lysergic acid by acidifying with glacial acetic acid. The total yield of this entire operation (including the iso change) is a little under 10 grams. As stated earlier, you may use only iso-alkaloid in the hydrolysis step above to get iso-lysergic acid which can be used in the synthesis of LSD to get iso-LSD, which can be changed to the active LSD as described later. *Note* iso-LSD is not active.

Some sources say that lysergic acid does not need to be purified. I feel that everything should be purified. In the event that something should go wrong with the formula, you can immediately rule out impurities as the cause. Also, impurities create unwanted byproducts which can be poisonous, creating dangers for the drug user. Purification of lysergic acid is very easy. Dissolve the acid in dilute ammonium hydroxide, treat with decolorizing carbon, reprecipitate (after filtering off and washing product from the carbon) with carbon dioxide.

*Convert iso-LSD to LSD.* Add 50 ml of ethanol and 5 ml of 4 N KOH per every gram of iso-LSD. Let this mixture stand for 2 hours at room temp. Evaporate in vacuo to get the LSD.

*Separate iso-LSD from LSD.* Dissolve the residue of the mixture of LSDs from the end of the formula in 120 ml of benzene and 40 ml of chloroform. Add tartaric or maleic acid to precipitate the LSD, filter off, add a little ether and put in refrigerator for several days to get a little more LSD, which is filtered off and added to the rest. Evaporate the filtrate in vacuo to get the iso-LSD and convert as above.

*LSD from Lysergic Acid.* This is based on the formula taken from CA, 50, 10803d (1956). Dissolve 5.5 g of dry lysergic acid in 125 ml of acetonitrile that has been cooled to -10° and cool further to -20° with an external freezing mixture. Add 8.8 g of trifluoroacetic anhydride in 75 ml of acetonitrile (this solution must be cooled to -20° before the addition). Be careful making this addition, so as not to raise the temp, etc. Let stand at -20° until all the lysergic acid dissolves (about 1 1/2 hours). Add 7.6 g of diethylamine (or analog) in 150 ml of acetonitrile and allow to set at room temp in darkness for 2 hours. Evaporate in vacuo to get the LSD, which can be separated from the iso-LSD as above.

### **LSD From Lysergic Acid**

This is taken from CA, 57, 5979 (1962). It is designed by Hofmann to give 1-methyl-D-lysergic acid, and is modified to give LSD and iso-LSD. Dissolve 0.54 g of lysergic acid in 10 ml of freshly distilled phosphorous oxychloride, stir 0.42 g of powdered, fresh phosphorous pentachloride. Allow to stand at room temp for 2 min, then at 90° for 2 min, then evaporate in vacuo. Extract the residue with hexane to give lysergic acid chloride hydrochloride. To save time you may extract the reaction mixture without evaporating. Add 2.5 g of the hydrochloride to a cooled solution of 7 ml of diethylamine (or analog) in 25 ml of methylene chloride that is cooled to 0°. *Note:* This solution is cooled to 0° before the addition. With stirring add 13.75 ml of dry pyridine and

stir for 30 min with cooling to keep the temp at 0° or a little below. Warm to room temp and continue the stirring for 90 min. Evaporate in vacuo to get the LSDs. Separate as already described.

### LSD From Lysergic Acid Monohydrate

This is, in my opinion, the best of all the methods. It was designed to be used to experiment with different types of amines, so if you would like to substitute diethylamine with another amine this would be the best bet. It also gives good yields (50% or better) and is very easy. The reference that gives it (JMC, 16, 532 (1973)), also gives potency data for many lysergamides and many of their formulas. The reading is good, interesting, informative, and the method given below gives no useful amount of iso-LSD, so separation of that product is not necessary. Both method A and B were from JMC, 16, 532.

*Method A.* A slurry of 3.15 g d-lysergic acid monohydrate (monohydrate means dry) and 7.3 g of diethylamine (or 0.1 mole of similar amine) in 150 ml of pure chloroform is heated to reflux. After the lysergic acid is dissolved (a few min) cool the mixture down to where reflux has stopped by removing the heat. Before the mixture cools any further 2 ml of phosphorous oxychloride is added at such a rate as to give reflux (about 2 min). After addition, reflux for 4-5 min further until an amber-colored solution results. Cool to room temp and wash the mixture with 200 ml of 1 M ammonium hydroxide. The chloroform solution was dried with  $MgSO_4$  (this would have to be after separation), filtered, and concentrated by evaporation in vacuo under a temp of 38° (at no time let the temp go over 40°). The last traces of solvent are removed at 2-5 mm. Dissolve the residue in a minimum amount of methanol and acidify with freshly prepared solution of 20% maleic acid in methanol (not aqueous) to precipitate the LSD in its maleate form. Filter the fluffy white needles, wash with cold methanol and air dry to get 2.2 g of LSD that requires no further purification.

*Method B.* This is proven to be more effective for using substituted amines. Mix the following slurry; 3.15 g of dry d-lysergic acid in 150 ml of chloroform and reflux in a 3 necked flask. As soon as you have the reflux adjusted add 7.3 g of diethylamine (or 0.1 mole of analog) in 25 ml of chloroform and at the same time, from another addition funnel mounted in the opposite neck of the flask, add 2 ml of phosphorous oxychloride so that both the additions begin at the same time. The additions should be timed so that they both finish after 2-3 min. Keep at reflux with gentle heating for another 3-5 min until a clear amber-colored solution results. Cool the solution to room temp and finish the work up, as in method A directly above, to get 2 g of LSD maleate. As in method A, this method gives very little or no iso-LSD, so don't worry about removing that.

### Lysergic Acid Monohydrate

I put this formula in this book specifically for the two methods (A and B) directly above, however, lysergic acid monohydrate can be used on any of the LSD formulas with possible success. I feel this may be easier than the first method given at the beginning of this chapter.

Dissolve 175 g of KOH in 1,750 ml of water in a flask of 5 liters volume equipped with a reflux condenser and a gas inlet tube. If a stirring device is not required, it should be removed and the open neck stoppered. Heat the mixture to 80° under a stream of nitrogen and add 500 g of ergotamine tartrate. Hold the temp at 80° for 2Vi hours with bubbling from the nitrogen filled gas inlet tube. Pour the mixture into a 5 gallon polyethylene bucket (made from the same

material as a plastic gas can) filled with about 6 liters of ice. Put the bucket in a cooling mixture to cool below 10°. Neutralize the mixture by adding cold dilute sulfuric acid to a congo red end point (pH 4.2). Lysergic acid and potassium sulphate will be seen to precipitate. Let stand for 2-3 hours in the 5-10° cooling mixture. Filter with vacuum assist, and let vacuo suck as dry as possible. Brake up the filter cake and put in a 2 liter beaker. Make a solution from 150 ml of liquid ammonia and 2.5 liters of very cold dry denatured ethanol and add to the reaction mixture. Stir for 1 hour and filter. Keep the filtrate and treat the filter cake to ^ the ammonia ethanol mixture as above. This second extract is filtered and the cake is washed with 250 ml of the ammoniacal ethanol mixture. Combine the filtrates, and evaporate to total dryness with a strong vacuum and gently heating. Do not heat at too high of a temp. Scrape the product from the vacuum vessel and put into a mortar. Mix 113 ml of methanol with 38 ml of water, and rinse the rest of the residue from the evaporation vessel and dump into the mortar with the rest of the product. The slurry in the mortar is ground up well and filtered. Wash the filter cake with 150 ml of cold water and use vacuum to suck dry for 1 hour. Break up the filter cake and dry at 80-85° under a high vacuum to get about 65-75 g of cream-white to gray-white powder. This is lysergic acid monohydrate.

I think that if you dry the lysergic acid (obtained from the ergot alkaloids by hydrolysis as described earlier) it will also work in methods A and B. This is how you dry lysergic acid: dry under high vacuum at 140-145° for 2-3 hours.

### ***LSD From Ergot Alkaloids***

This was invented by Hofmann and is a superior method because you may proceed from the ergot alkaloids to LSD without isolating the lysergic acid. CA, 57,12568 (1962).

Add 1.2 g of ergotamine hydrochloride to 4 ml of anhydrous hydrazine and heat 1 hour at 90°. Add 20 ml of water and evaporate in vacuo, to get d-iso-lysergic acid hydrazine. 1 g of the lysergic hydrazine is powdered well and added to 40 ml of 0.1 N (ice cold) HCl acid. To this, cooled to 0°, is added 4 ml of 1 N Na nitrite, with good stirring. Over 2-3 min, add 40 ml of 0.1 N HCl acid to get pH to 5. Let stand for 5 min, basify with 1 N NaHCO<sub>3</sub>, extract with 100 ml of ether, and then with 50 ml of ether. Wash the ether layer with water and dry, then evaporate in vacuo at 10°. Dissolve the resulting yellow azide in about 5 ml of diethylamine at 0° and then heat in a metal bomb at 60° for 1 hour. If a bomb is unavailable you may get by with heating for 3-4 hours at 45° in a *vented* flask under a nitrogen atmosphere. Also, I would flush the bomb with nitrogen before sealing and heating. Remove heat after time elapses and let stand (after bleeding off pressure for bomb method) for 2 hours and evaporate in vacuo to get 0.7 g of LSD and 0.15 g of iso-LSD. The iso-LSD will not do anything (good or bad) if consumed, so you may leave it in with the LSD. You may also separate it and convert it to LSD as in the formulas above.

### **LSD From Lysergic Acid JOC, 24, 368 (1959)**

This is a simple method that gives good yields of LSD with very little (if any) iso-LSD. You will be required to purchase sulfur trioxide from Allied Chemical and Dye Corp (ask for Sulfan B, or SO<sub>3</sub>), but this is not a suspicious chemical so ordering is not a problem.

*Sulfur trioxide-Dimethylformamide complex (SO<sub>3</sub>DMF)*. This is a reagent required for this method of LSD production. A completely dry 22 liter flask (round bottom) in an ice cooling bath is fitted with a condenser, stirring device, addition funnel, then is filled with 10-11 liters of

DMF (dimethylformamide) that has been freshly distilled under reduced vacuum. Use drying tubes to protect the reaction from all moisture (including atmospheric moisture). 2 pounds of sulfur trioxide (SO<sub>3</sub>) are then added, with a great deal of caution, over 4-5 hours with stirring, dropwise. The temp must be held between 0°-5° during this addition. Stir for 1-2 hours after the addition until some separated, crystalline SO<sub>3</sub>-DMF complex has dissolved. Store in the dark in a suitable vessel, in a refrigerator for not more than 3 months. Upon storage, the complex will turn yellow and then orange. This is normal. As long as it is less than 3-4 months, it is still good. This mixture gives a molarity of 1 (1 M) and can be made using ½ or ⅓ of the amounts above to scale down the version, still giving a 1 M solution.

*Lysergic Acid Amide.* A solution of 7.1 g of lysergic acid monohydrate. As with any of the formulas calling for the monohydrate, you may substitute dry or anhydrous lysergic acid in place of the lysergic acid monohydrate by using a smaller amount of the dry lysergic acid. I have found that dividing the amount of the monohydrate by the constant of 1.1 gives a close amount of dry lysergic to use, e.g., 7.1 divided by 1.1 = 6.5 g, to substitute in the formula. Likewise, the monohydrate can be figured into a formula calling for dry lysergic, 6.5 times 1.1 = 7.1 g. Also, if a formula does not specify if the lysergic acid is to be dry, e.g., add 0.54 g of d-lysergic acid, then always use dry or monohydrate as any water will kill the yield. Dry as stated above. As a general rule dry your lysergic acid as soon as you plan to use it (because it collects H<sub>2</sub>O from air). 1 g of lithium hydroxide hydrate in 200 ml of methanol is prepared. Distill off the solvent (methanol) on a low temp steam bath under reduced pressure, or evaporate under vacuum. The resulting glass-like lithium lysergate residue, is dissolved in 400 ml dry dimethylformamide (DMF). 200 ml of this DMF is distilled off with 15 mm pressure through a 12 inch helices-packed fractional column. Cool the resulting solution to 0°, and with stirring, quickly add the SO<sub>3</sub>-DMF solution (50 ml of 1 M). The mixture is stirred with cooling for 10 min and 125.0 mmol. of the desired amine is added (that would be 9.05 g of diethylamine). The stirring and cooling are continued for 10 min after the amine addition, and then the reaction is decomposed by adding 400 ml of water. After stirring thoroughly the reaction mixture is treated with a saturated solution of NaCl. Table salt and water are fine for this if the salt is *not* iodized. Use 200 ml of the saturated solution on the reaction mixture. Extract the amide (LSD) with repeated portions of ethylene dichloride. Test for completeness of extraction with Van Urk test or hold extract under black light briefly and look for fluorescence as compared with non-extracted ethylene dichloride, or use any indole test. The combined extracts are dried (with MgSO<sub>4</sub> as usual), and then evaporated under vacuo to a syrup. Keep the temp below at least room temp. Dissolve the residue in about 60 ml of dry methanol, acidify with solid maleic acid, treat to turbidity with dry ether, and refrigerate for 3-6 hours to get colorless soft needles of LSD maleate which are filtered from the mother liquor. More crystals may be obtained by evaporating the mother liquor in a cool, dark place under vacuo.

### **Things You Must Remember When Working With Ergot Alkaloids, Lysergic Acid, And LSD**

These compounds are very sensitive and even unstable. This means that the following steps must be taken to keep from ruining your compound or yield.

1. Always use red or yellow photographic dark room light bulbs during any step of LSD manufacture. Direct sunlight, electric filament, or fluorescent light bulbs (etc.) will hurt the above compounds. Dark room bulbs are cheap and are a must.

1. Keep all forms of H<sub>2</sub>O out of the reaction. Thoroughly dry all the glass ware to be used. Use a drying tube filled with anhydrous MgSO<sub>4</sub> (calcium chloride reacts with amines in an unfavorable way and should not be used). I can't be there to hold your hand and guide you through every step, so unless the formula says to add water, the drying tube should be in use, and after the water addition is over, the drying tube goes back on. This way the reaction is always protected even if it does not need to be. Better safe than sorry. Also, if you're not sure if you should use dry reagents, use dry reagents anyway. Also dry the lysergic acid (as described above) and any other precursors in whatever drying process required for that compound before use. Dry the finished LSD or even any intermediate along the way after you have completed the product. Likewise, dry an intermediate that you may have purchased from a chemical supplier.
3. Keep oxidizing agents from these items. Even the oxygen in the air can oxidize some of these compounds. The formula states that during some of the reactions above, an inert gas (nitrogen) must be used for an atmosphere inside the reaction vessel. Nitrogen can be obtained in small bottles (tanks) at a very reasonable fee, without any questions asked. Make sure you use a regulator and introduce a slow stream into the vessel by way of a gas inlet tube or an equivalent. Always flush the vessel before putting any reagents into it (flush the air out with nitrogen). I would use a nitrogen atmosphere from the very beginning of the formula to the very end, even if the formula did not specify its use. Very few of the above formulas call for a nitrogen atmosphere during evaporation, but I feel this may be bad for yield and or potency. LSD has many doses per gram, and if you lose % g because you were too cheap to use three dollars worth of nitrogen, you have lost about 2,000 doses at \$5 a dose = \$10,000 of LSD wasted. Better safe than sorry? Also, any precursors you make or buy should be stored in a nitrogen atmosphere, as should LSD. This can be done by poking a gas inlet tube into the vessel (just above or a little below the substance) flushing the air out with a moderate stream of nitrogen then quickly reinstall the cap or stopper.

The best way to store LSD is by producing it in the maleate form. This not only makes it resistant to oxidation, but it purifies it, too. Use the procedure above (JOC, 24, 368, or CA, 57, 5979) when you get to the last dry-and-evaporate-in-vacuo step, then treat the residue as specified.

4. Never subject these compounds to excessive heat, or any type of temperature warmer than the inside of your refrigerator. Even LSD maleate will decompose in excess heat, so store in a refrigerator. Keep evaporation procedures cooled. This will slow the evaporation process down, but that is better than losing the product. Some of the above formulas require heat for a reaction. This is Ok, but do not exceed the temp stated at any time and never heat longer than needed. Also, nitrogen atmospheres are used during heating operation.

### Substituents

LSD analogs (lysergic acid amides) can be prepared by substituting amines in place of diethylamine. The potency usually drops anywhere from 33% to 75% depending on the substituent. Diethylamine is highly suspicious, and the substituent will produce a lysergamide that is most likely legal, as legislation has only singled out lysergic acid diethylamide. Little work has been done on the potency of substituted lysergamides, so a little experimentation by you may be in order. Personally, I would like to try substituting a potent phenethylamine or phenylisopropylamine such as DOM (STP) or 4-bromo-2,5-dimethoxyamphetamine. If I could



get a government grant, or maybe a grant from a major pharmaceutical corporation, like Upjohn or Lilly, then I could play around with such experiments.

The following substituents give lysergamides with potencies as indicated in doses per gram (remember that LSD gives about 6,000 to 9,000 doses):

Ethylpropylamine	2,000 to 5,000
Morpholide	600 to 2,000
Methylpropylamine	600 to 1,000
Dipropylamine	600 to 1,000
Methylethylamine	400 to 600
Dimethylamine	300 to 400
Pyrrolidide	300 to 400

As a point of reference, DOM (STP) is one of the most powerful amphetamines, at 200 doses per gram. At \$5 a line, its value is about 5 times 200 = \$1,000 a gram. For more info see JMC, 16,532(1973).

*Claviceps purpurea* is not the only place to get d-lysergic amides. The plant group of Convolvulacea has been found to possess lysergic acid amides such as ergine and several others. These Convolvulacea type of plants do not cause the dreaded St. Anthony's fire, as does *claviceps purpurea*, and as a matter of fact, they are hallucinogenic if eaten in large doses. Care must be taken that the seeds have not been treated with poison to discourage usage as a mind alterant, or treated with methyl mercury to prevent spoilage. Untreated seeds can be obtained from Magic Garden Herb Co, PO Box 10, Pineola, CA 94930.

When these seeds are to be used for LSD syntheses, make sure to clean off the white layer that surrounds them by singeing or mild burning. Also, ask for Hawaiian Rose Wood, as these are the only ones that contain an appreciable amount of lysergic related compounds. These compounds must be extracted as below, hydrolyzed (like ergotamine) as above, and then used in any of the formulas that require d-lysergic acid or possibly used directly in the Hofmann hydrazine method; CA, 57, 12568 (1962). These seeds have very little amide, so you can plan on quite a lot of work in the extraction step. According to A. HofTer and H. Osmond, the most amide plentiful species (Woodrose) has a minute 3 to 6 mg of amide per every gram of seed. This means that if you extract very thoroughly, you will require a little over 200 g of seeds to get 1 g of amide, which will be reduced further after hydrolysis to give you about 0.5 g of usable d-lysergic acid. Extract as follows.

Pulverize the seeds in a clean blender until they are a fine powder. Put this powder into a beaker, add 1 liter of petroleum ether to every 900 to 1000 g of powdered seeds, stopper the beaker to prevent evaporation and let set for 3 days. Filter off the petroleum ether and let evaporate to make sure no amides were extracted (there should not be much, if any) from the ether. Add 1 liter of methanol (dry is best) and let soak for 4 days with vigorous shaking, now and then. Filter off the methanol and evaporate it under vacuo (vacuum speeds the process). In the meantime, add 500 ml of fresh methanol to the powder and extract it again for 3 or 4 days.

Filter as before and extract again with about 300 ml of methanol. Combine the residues of all extractions and hydrolyze.

## PHENCYCLIDINE HYDROCHLORIDE

*Phencyclidine and Other 1-Phenylcyclohexylamines.* Phencyclidine (PCP or angel dust) and its analogs create many different types of effects, dependent mainly on the individual user. It was first used to immobilize primates and is still used as an analgesic and/or anesthetic agent. It has been used on humans for the same purpose with limited success. I chose to put PCP into the hallucinogens chapter instead of the analgesics chapter because of the hallucinations the drug produces.

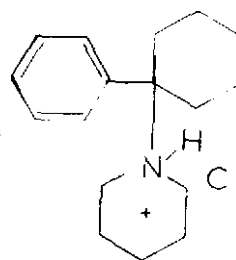

As stated above, the effects are mainly determined by the user. Some people experience paranoia, others have fits of rage, and others have great euphoria. Mood alterations are always accompanied with time, perception and visual hallucinations. Some people have tried the drug and do not agree with it, so I do not approve of the practice of telling people that your PCP is THC or some other hallucinogen. These drugs are quite potent, so use them with a great deal of respect (I think that overdoses have given PCP the bad reputation that follows it today) as bummers from this drug have occurred often.

The way that ethylamine, diethylamine, methylamine, piperidine, etc., can be used as analogs of one or another reminds me of the synthesis of LSD or DMTs. The formula is quite easy to carry out and it gives good yields in large quantities. *Note:* Given are several different methods. You may use any way that you feel will suit your needs and you may substitute any of the amines with an equimolar amount of amine analog to produce the desired 1-phenylcyclohexylamine. However, the formulas stated give the best yields obtainable with that particular amine.

These drugs are active orally, intermuscularly, and also by smoking. They should be kept in a dark, well stoppered bottle, in a freezer as much as possible. CA, 13881 (1963).

**METHOD 1.** A mixture of 100 g of anhydrous ethylamine and 220 g of cyclohexanone is kept 16 hours, shaken with solid KOH, and the oil layer is removed by decantation. Distill the oil layer in vacuo to get the intermediate N-cyclohexylidenethylamine. Prepare a mixture of phenyllithium by mixing 11 g of lithium and 76 ml PhBr in 500 ml of Et<sub>2</sub>O. Add the phenyllithium dropwise to a solution of 51 g of the N-cyclohexylidenethylamine in 500 ml of Et<sub>2</sub>O, with stirring and cooling, to keep the temp at 0°. Stir for one hour and then decompose by adding water. Separate the Et<sub>2</sub>O layer, wash with H<sub>2</sub>O and distill to get 1-phenylcyclohexylethylamine or analog. The hydrochloride form is obtained in the usual way, as given below.

**METHOD 2.** A mixture of 170 g of piperidine, 220 g of cyclohexylamine, and 750 ml of benzene is azeotropically distilled until the evolution of H<sub>2</sub>O stops, then vacuum distill to get cyclohexenyl-piperidine. p-toluenesulfonic acid monohydrate (190 g) in 250 ml of PhMe is heated under a water trap until all the H<sub>2</sub>O is removed, then add a solution of 165 g of cyclohexyl-piperidine in 500 ml of Et<sub>2</sub>O, with cooling, to keep temp at 0°. A solution of 1 mole of PhMgBr (made from 157 g of PhBr and 24 g of Mg) in 750 ml of Et<sub>2</sub>O is added (still holding the temp at 0° to 5°). The mixture is stirred for an additional 30 min

after the dropwise addition is complete. Decompose the mixture by adding an excess saturated  $\text{Ni}^{\text{II}}\text{Cl}_2$  and  $\text{NH}_4\text{OH}$ . The  $\text{Et}_2\text{O}$  layer is removed, dried over  $\text{K}_2\text{CO}_3$ , and distilled to give phenylcyclohexylpiperidine. Convert to the hydrochloride form by dissolving the free base in an excess of iso-PrOH-HCl and then precipitate the salt (the hydrochloride) with EtO and crystallize from  $\text{Et}_2\text{O}$ -iso-PrOH (this is a mixture).

## MUSCIMOLE

Muscimole can be found in the mushroom species *Amanita muscaria* (fly agaric). It is a powerful drug (e.g., 10 mg for oral dose) but its synthesis is rather difficult. I feel that there are better drugs that can be made much more easily and cheaply, so I have only included two formulas for the drug. The first formula uses ibotenic acid for a starting material. To make ibotenic acid requires more work than to make muscimole, but ibotenic acid can be purchased from many suppliers at a lower cost than to synthesize muscimole. Ibotenic acid is stocked by Aldrich, Sigma, Chemical Dynamics, Regis Chemical Reagents, etc. Look in Chemical Sources for more suppliers and then call for the best price, as sometimes there is a large price difference. Ibotenic is not a psychedelic (not a useful one anyway), so you could purchase it without alerting the DEA. The last I heard, muscimole is not illegal either, so you may be able to order that through the mail also.

*Muscimole from Ibotenic Acid.* Reflux ibotenic acid in 10 times its weight of water.

*Muscimole.* CA, 65, 2266 (1966). Dissolve 626 g of 2-(2-nitrovinyl) furan in 3.1 liters of 48% HBr and 6.25 liters glacial acetic acid, then heat on steam bath for 9 hours. Concentrate by evaporating in vacuo to 3 liters. Add 3 liters of water, boil and add decolorizing carbon, filter hot, cool, and filter again. Extract the filtrate with 2 liters of chloroform using small portions. Add residue to the precipitate and recrystallize with benzene-cyclohexane to get intermediate. 44 g of the above intermediate is added to 440 ml coned sulfuric acid and add 80 g of  $\text{CrO}_3$  (that has been added to 80 ml of water) dropwise over three hours while maintaining a temp of 15-20°. Pour onto 800 g of ice and extract the aqueous solution with three 500 ml portions of ether. Evaporate the ether in a vacuum to get 3-Br-isoxazole-5-COOH and recrystallize from benzene-toluene to purify. Dissolve 30 g of this above product in 500 ml methanol along with 27 g of KOH and stir for 2 hours at 140°. Cool and add  $1\frac{1}{2}$  liters of water and extract with three  $\frac{1}{2}$  liter portions of ether. If you encounter much color, you should boil for a short time with a small amount of decolorizing carbon, then filter hot and acidify with small portions of concentrated HCl acid. Filter cool and recrystallize with benzene to get 3-methoxy-isoxazole-5-COOH. Dissolve 5.2 g of this last compound with 100 ml of 3% HCl acid in methanol and reflux for 3 hours. Evaporate in vacuo and recrystallize the residue with petroleum ether. Add 0.8 g of the recrystallized product with stirring to 40 ml of aqueous ammonia (have a density of .90) and stir for 30 min at room temp. Filter and wash with cold water, then dry, to get 500 mg of product, which is a carboxamide. Dissolve 37.8 g of  $\text{NaBH}_4$  in 100 ml of diglyme and 32 ml  $\text{BF}_3$  etherate in diglyme, then add to 4.6 g of the carboxamide above in 100 ml of tetrahydrofuran and reflux for 48 hours. Add hydrogen chloride (HCl acid), evaporate in vacuo and dissolve the residue in water. Basify with 50% KOH and extract with ether, dry, filter, evaporate in vacuo to get intermediate. One g of this intermediate is added to 10 ml of glacial acetic acid and 4.5 g of HBr and reflux for 1 hour. Evaporate to get muscimole. As you can see, this is a long, drawn out process that is not worthwhile in cost or yield. I figured that, for the price of the chemicals, you

could buy 4 or 5 times as much ibotenic acid and save your self days of hard work, plus gain much more product than the formula could ever give. There are lots of different formulas, but the result is the same.

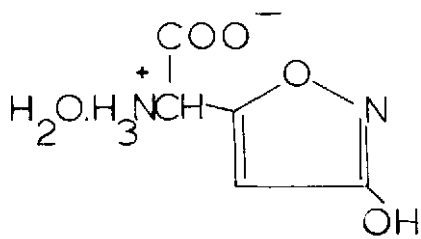

*Ibotenic Acid*

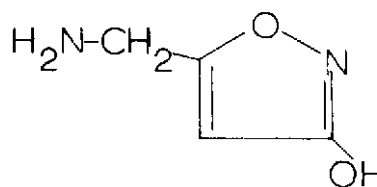

*Muscimole*

## COCAINE

Although this drug is categorized as a local anesthetic, I have chosen to put it in with the hallucinogens because of the psychotomimetic effects that it produces. Cocaine is not a phenylethylamine, but it produces central nervous system arousal or stimulant effects which closely resemble those of the amphetamines, the methylenedioxyamphetamines in particular. This is due to the inhibition by cocaine of re-uptake of the norepinephrine released by the adrenergic nerve terminals, leading to an enhanced adrenergic stimulation of norepinephrine receptors. The increased sense of well being and intense, but short lived, euphoric state produced by cocaine requires frequent administration.

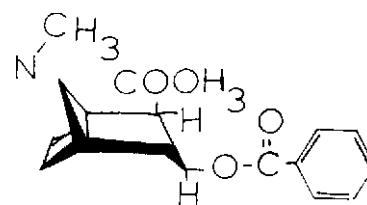

Cocaine does not penetrate the intact skin, but is readily absorbed from the mucus membranes, creating the need to snort it. This accounts for the ulceration of the nasal septum after cocaine has been snorted for long periods.

The basic formula for cocaine starts by purchasing or making tropinone, converting the tropinone into 2-carbomethoxytropinone (also known as methyl-tropan-3-one-2-carboxylate), reducing this to ecgonine, and changing that to cocaine. Sounds easy? It really is not very simple, but with Reagan's new drug policies, cracking down on all of the drug smuggling at the borders, this synthetic cocaine may be the source of the future. This synthesis is certainly worth performing with the high prices that cocaine is now commanding. As usual, I will start with the precursors and intermediates leading up to the product.

*Succindialdehyde*. This can be purchased, too. 23.2 g of succinaldoxime powder in 410 ml of 1 N sulfuric acid and add dropwise with stirring at 0° a solution of 27.6 g of sodium nitrite in

250 ml of water over 3 hours. After the addition, stir and let the mixture rise to room temp for about 2 hours, taking care not to let outside air into the reaction. Stir in 5 g of Ba carbonate and filter. Extract the filtrate with ether and dry, evaporate in vacuo to get the succindialdehyde. This was taken from JOC, 22, 1390 (1957). To make succinaldoxime, see JOC, 21, 644 (1956).

*Complete Synthesis of Succindialdehyde.* JACS, 68, 1608 (1946). In a 2 liter 3 necked flask equipped with a stirrer, reflux condenser, and an addition funnel, is mixed 1 liter of ethanol, 67 g of freshly distilled pyrrole, and 141 g of hydroxylamine hydrochloride. Heat to reflux until dissolved, add 106 g of anhydrous sodium carbonate in small portions as fast as reaction will allow. Reflux for 24 hours and filter the mixture. Evaporate the filtrate to dryness under vacuo. Take up the residue in the minimum amount of boiling water, decolorize with carbon, filter and allow to recrystallize in refrigerator. Filter to get product and concentrate to get additional crop. Yield of succinaldoxime powder is a little over 40 g, mp is 171-172°.

5.8 g of the above powder is placed in a beaker of 250 ml capacity and 54 ml of 10% sulfuric acid is added. Cool to 0° and add in small portions of 7 g of sodium nitrite (if you add the nitrite too fast, nitrogen dioxide fumes will evolve). After the dioxime is completely dissolved, allow the solution to warm to 20° and effervescence to go to completion. Neutralize the yellow solution to litmus by adding small portions of barium carbonate. Filter off the barium sulfate that precipitates. The filtrate is 90% pure succindialdehyde and is not purified further for the reaction to create tropinone. Do this procedure 3 more times to get the proper amount for the next step, or multiply the amounts given by four and proceed as described above.

Take the total amount of succinaldehyde (obtained from 4 of the above syntheses combined) and without further treatment or purification (this had better be 15.5 g of succindialdehyde) put into an Erlenmeyer flask of 4-5 liters capacity. Add 21.6 g of methylamine hydrochloride, 46.7 g of acetonedicarboxylic acid, and enough water to make a total volume of 2 liters. Adjust the pH to 8-10 by slowly adding a saturated solution of disodium phosphate. The condensate of this reaction (allow to set for about 6 days) is extracted with ether, the ethereal solution is dried over sodium sulphate and distilled, the product coming over at 113° at 25 mm of pressure is collected. Upon cooling, 14 g of tropinone crystallizes in the pure state. Tropinone can also be obtained by oxidation of tropine with potassium dichromate, but I could not find the specifics for this operation.

*2-Carbomethoxytropinone.* A mixture of 1.35 g of sodium methoxide (this is sodium in a minimum amount of methanol), 3.5 g of tropinone, 4 ml of dimethylcarbonate and 10 ml of toluene is refluxed for 30 min. Cool to 0° and add 15 ml of water that contains 2.5 g of ammonium chloride. Extract the solution after shaking with four 50 ml portions of chloroform, dry, evaporate the chloroform in vacuo. Dissolve the oil residue in 100 ml of ether, wash twice with a mixture of 6 ml of saturated potassium carbonate and three ml of 3 N KOH. Dry and evaporate in vacuo to recover the unreacted tropinone. Take up the oil in a solution of aqueous ammonium chloride and extract with chloroform, dry, and evaporate in vacuo to get an oil. The oil is dissolved in hot acetone, cool, and scratch inside of flask with glass rod to precipitate 2-carbomethoxytropinone. Recrystallize 16 g of this product in 30 ml of hot methyl acetate and add 4 ml of cold water and 4 ml of acetone. Put in freezer for 2 1/2 to 3 hours. Filter and wash the precipitate with cold methyl acetate to get pure product.

*Methylecgonine.* 0.4 mole of tropinone is suspended in 80 ml of ethanol in a Parr hydrogenation flask (or something that can take 100 psi and not react with the reaction, like stainless steel or glass). 10 g of Raney Nickle is added with good agitation (stirring or shaking) followed by 2-3 ml of 20% NaOH solution. Seal vessel, introduce 50 psi of hydrogen atmosphere (after flushing

vessel with hydrogen) and heat to 40-50°. After no more uptake of hydrogen (pressure gauge will hold steady after dropping to its lowest point) bleed off pressure and filter the nickle off, rinse out bottle with chloroform and use this rinse to rinse off the nickle while still on the filter paper. Make the filtrate basic with KOH after cooling to 10°. Extract with chloroform dry, and evaporate the chloroform in vacuo to get an oil. Mix the oil plus any precipitate with an equal volume of dry ether and filter. Add more dry ether to the filtrate until no more precipitate forms, filter and add to the rest of the precipitate. Recrystallize from isopropanol to get pure methylecgonine. Test for activity. If active, skip down to the step for cocaine. If not active, proceed as follows. Stir with activated carbon for 30 min, filter, evaporate in vacuo, dissolve the brown liquid in methanol, and neutralize with 10% HCl acid in dry ether. Evaporate the ether until the two layers disappear, and allow to stand for 2 hours at 0° to precipitate the title product. There are many ways to reduce 2-carbomethoxytropinone to methylecgonine. I chose to design a Raney Nickle reduction because it is cheap and not as suspicious as LAH and it is much easier than zinc or sodium amalgams.

*Cocaine.* 4.15 g of methylecgonine and 5.7 g of benzoic anhydride in 150 ml of dry benzene are gently refluxed for 4 hours taking precaution against H<sub>2</sub>O in the air (drying tube). Cool in an ice bath, acidify carefully with hydrochloric acid, dry, and evaporate in a vacuum to get a red oil which is treated with a little portion of isopropanol to precipitate cocaine.

As you can see, this is quite a chore. The coca leaves give ecgonine, which as you can see, is only a jump away from cocaine. If you can get ecgonine, then dissolve 8.1 g of it in 100 ml of ethanol and pass (bubble) dry HCl gas through this solution for 30 min. Let cool to room temp and let stand for another V/i hours. Gently reflux for 30 min and evaporate in vacuo. Basify the residue oil with NaOH and filter to get 8.4 g of methylecgonine, which is converted to cocaine as in the cocaine step above.

Below is given a somewhat easier method of producing tropinone by the general methods of Willstatter, who was instrumental in the first synthetic production of cocaine and several other alkaloids. After reviewing this method, I found it to be simpler than the above in many respects.

*Tropinone.* 10 g of pyrrolidinediethyl diacetate are heated with 10 g of cymene and 2 g of sodium powder, the reaction taking place at about 160°. During the reaction (which is complete in about 10 min) the temp should not exceed 172°. The resulting reaction product is dissolved in water, then saturated with potassium carbonate, and the oil, which separates, is boiled with dilute sulfuric acid. 2.9 g of tropinone picrate forms and is filtered.

Here are two more formulas devised by Willstatter that produce tropinone from tropine. Take note of the yield differences.

*Tropinone.* To a solution of 25 g tropine, dissolved in 10 times its weight of 20% sulfuric acid are added 25 g of a 4% solution of potassium permanganate in 2 or 3 g portions over 45 min while keeping the temp at 10-12°. The addition of permanganate will cause heat (keep the temp 10-12°) and precipitation of manganese dioxide. The reaction mixture is complete in 1 hour. A large excess of NaOH is added and the reaction is steam distilled until 1 liter of distillate has been collected. The tropinone is isolated as the dibenzal compound by mixing the distillate with 40 g of benzaldehyde in 500 cc of alcohol and 40 g of 10% sodium hydroxide solution. Let stand several days to get dibenzaltropinone as yellow needles. Yield: 15.5 g, 28%. Recrystallize from ethanol to purify.

*Tropinone,* A solution of 12 g of chromic acid in the same amount of water (12 g) and 60 g of glacial acetic acid is added dropwise with stirring over a period of 4 hours to a solution of

25 g of tropine in 500 cc of glacial acetic acid that has been warmed to 60-70° and is maintained at this temp during the addition. Heat the mixture for a short time on a steam bath until all the chromic acid has disappeared, cool and make strongly alkaline with NaOH. Extract with six 500 cc portions of ether and evaporate the ether in vacuo to get an oil that crystallizes readily. Purify by converting to the picrate or fractionally distill, collecting the fraction at 224-225° at 714 mm vacuo.

The tropinones can be used in the above formula (or in a formula that you have found elsewhere) to be converted to cocaine. Remember to recrystallize the 2-carbomethoxytropinone before converting to methylecgonine.

## THCs

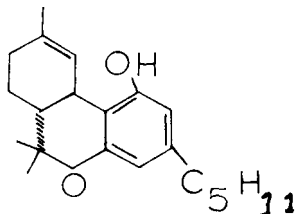

### *3,4- Trans- Tetrahydrocannabinol*

THC is one of the most used of all recreational drugs. It is usually smoked or eaten in its natural form (3,4-trans-THC) while still in the cannabis sativa plant. Rarely is pure THC separated from the plant which produces it. Occasionally THC is separated to make smuggling easier by reducing tons of plant bulk into small pounds of pure THC.

I have not met many people who have done pure uncut THC, but those that have will confess to its potency. Although THC is nearly impossible to overdose on, one mg smoked or five mg eaten (this refers to pure THC) produces really extraordinary hallucinations.

Back in the early 1970's making THC and treating alfalfa or parsley with it was quite common in some areas. This was due to the ease with which olivetol and menthadienol could be obtained and converted into THC. These precursors are still easily made into THC, but their availability and their suspiciousness makes them nearly useless. Much literature on the effects and synthesis of THC has been published. See the recommended reading to find more information, or ask a librarian at most any library.

## THE PRECURSORS

Following is a new and simple synthesis of olivetol. This is one of the easier formulas I have ever seen for 5-n-Pentyl resorcinol (olivetol). It begins with formulas for intermediates. Note the similarity of this synthesis with those for amphetamines.

*Olivetol.* (5-n-pentyl Resorcinol) T.L., 2511 (1975).

*Methyl Ethyl Ketone.* 1 mole (20 g) of methylacetoacetic ester are refluxed with 250 cc of baryta water (saturated) until the oily layer disappears. Distill on a water bath to 90°. Stir violently or shake for three hours with a saturated solution of sodium bisulfate, and collect the crystals and distill with an excess of dilute sulfuric acid at 90°. The distillate is dried over calcium chloride and distilled again, retaining the fraction at 79-82°. Yield: 70% theoretical (7 g).

*3,5-Dimethoxybenzaldehyde.* (This can be purchased for a modest fee from chemical supply houses. If you prefer to use the "make your own" method of procurement; see the procurement chapter, then follow the instructions below.) Aust. J. Chem. 21, 2979 (1968). Make a mixture of 50 g 3,5-dihydroxybenzoic acid, 200 ml dimethylsulfate, 250 g K<sub>2</sub>CO<sub>3</sub>, in one liter of acetone, and reflux for 4 hours. Distill the acetone off and extract the residue with 1 liter of ether. Wash the extracts with two 100 ml portions of coned ammonium hydroxide, two 100 ml portions of



dilute HCl and 100 ml portion of water, then dry and evaporate in vacuo (to speed evaporation) to get the benzoate. Recrystallize from H<sub>2</sub>O-methanol mixture and evaporate again to get about 45 g.

Add 78.5 g of the above benzoate in 300 ml of ether to a stirred suspension of 19 g lithium aluminum hydride in 200 ml of ether at such a rate as to give gentle reflux. After the addition, reflux for 2½ hours, then cool. Add 50 ml of wet ether and 100 ml dilute sulfuric acid. Evaporate the ether extract in vacuo to get about 60 g of 3,5-dimethoxybenzyl alcohol and recrystallize with ether-pentane. To a cooled, stirred slurry of CrO<sub>3</sub> and 250 ml pyridine, add 8.4 g of the above alcohol in 25 ml pyridine and after the addition let stand at room temp for 1 hour. Add 60 ml of methanol, let stand 2 hours, and dilute with 500 ml of 5% NaOH and 500 ml ether. Extract the aqueous layer with ether and wash the combined ether layers with water (500 ml), then three 500 ml of 5% sulfuric acid, again with 500 ml water, and then 200 ml saturated NaCl. Dry and evaporate in vacuo to get 7 g 3,5-dimethoxybenzaldehyde. (This benzaldehyde is not much more suspicious to the DEA than the LAH used to make it. It may be cheaper for you to buy than to make.)

*Condensation of 3,5-Dimethoxybenzaldehyde with Methyl Ethyl Ketone.* 1 mole of the aldehyde is mixed with 3 moles of ketone and a 7% NaOH solution. This mixture is heated to 70-80° for 4 hours. The resulting product is recrystallized from petroleum ether to give a 65% yield of white needles. Mp: 70-71°.

*Hydrogenation of the Condensation Product.* The above product can be hydrogenated by using 10% palladium carbon catalyst and the methods in the reductions chapter.

*Reduction of the Above Hydrogenated Product.* The above product is reduced by using Raney Nickel as instructed in the reductions chapter. The resulting product is then demethylated as described in some of the formulas to follow.

*Olivetol.* (5-Alkyl Resorcinol) BER 69, 1644 (1936). Mix 25 g of ethyl-3,4,5-trimethoxy benzoyl acetate and 2.0 g of clean sodium in 100 ml ethanol and warm to react. Add 2 g n-propyl iodide (this may be replaced with n-amyl iodide) and heat on a steam bath for 12 hours, then neutralize and remove the ethanol by distillation. Extract the residue with ether, dry, and evaporate in vacuo to get 30 g of the alkyl acetate. Heat 22 g of this acetate in 5% KOH ethanolic solution for 1 hour at 50° and let stand to precipitate 14 g of 3,4,5-trimethoxyvalerophenone. Mix 11 g of the above product with 60 g of sodium in 600 ml ethanol. Warm and after dissolving the sodium add 2 liters of water. Make acidic with HCl acid and remove the ethanol by distillation. Extract with ether, dry, and evaporate the ether in vacuo to get 14 g olivetol dimethyl ether. To demethylate this ether add it to 70 ml of hydrogen iodide and heat to boiling and reflux for two hours. Distill and keep the fraction at 160°-170° with 3-4 mm of vacuum applied to the distillation set-up. Yield: about 6 g.

*Olivetol in Two Steps.* Prepare the Grignard reagent by adding 1 mole of benzyl chloride to 24.5 g of clean magnesium in 200 ml of dry ether. Add rapidly to the Grignard reagent 46 g of n-butyl p-toluene in 300 ml dry ether and reflux with stirring for 48 hours while taking precautions against atmospheric H<sub>2</sub>O. Add a mixture of ice-water and 80 ml of coned sulfuric acid. Separate the ether layer, dry it, and evaporate to remove the ether to get olivetol dimethyl ether which needs to be demethylated as in the formula directly above. This formula was designed from the information given in TL, #29, 2511 (1975).

*Olivetol.* CJC, 52, 2136 (1974). This is a simple high yield method. Clean magnesium turnings (1.7 g) are covered with 25 ml of dry ether and 1 g of laurylbromide (or n-hexyl bromide, etc.)

and added to start formation of the Grignard reagent. 16.5 g of lauryl bromide in 25 ml of dry ether, is also added and the mixture is refluxed with precautions to exclude moisture, and with good stirring until all the magnesium is dissolved completely. This should take about 3-6 hours. A couple of drops of methyl iodide will help speed things up. A solution of 3,4,5-trimethoxybenzaldehyde or 3,4,5-trimethoxyphenyl methyl ketone (0.05 mole, or about 9.5 g) in 75 ml of dry benzene is added dropwise with stirring under reflux for 2 hours and then allowed to cool. 50 ml of 1.5 N HCl acid is added carefully. The aqueous layer is separated and extracted with 50 ml of benzene and the organic phases are combined, dried with MgSO<sub>4</sub>, and coned to give the carbinol. According to the literature cited, the carbinol needs no further purification to be used in the next step; however, if you want, you may recrystallize in a combination of hexane and chloroform.

Clean sodium sand (1 g) was prepared (L.F. Fieser, Organic Experiments, D.C. Heath and Co., 1964, pp. 142-143, or I think that the sodium amalgam given in the reductions chapter will work good, or use the sodium reduction above for larger scale production) in a round bottom flask and covered with dry benzene (5 ml). The above carbinol (2.5 mole) is added with good stirring. A two necked adapter is fitted to the flask employing a dropping funnel and a reflux condenser. The mixture, while being stirred, is kept at 80-85° on an oil bath. 15 ml of ethanol is added dropwise to keep the reaction moderate. After the addition, the mixture is stirred and maintained at 80-85°. Inspect for the disappearance of sodium and pour into 300 ml of water, acidify with HCl, and extract with three 50 ml portions of ether. Dry the extracts with MgSO<sub>4</sub> and concentrate by evaporation. The product can be purified by chromatography on silica gel and eluted with chloroform in hexane. The purified product is demethylated like this: 90 ml of pyridine is distilled with 100 ml of coned HCl acid until a temperature of 210° is reached. Cool to 140° and add 4.5 g of the above product and reflux for 2 hours under N<sub>2</sub>. Cool and pour into water, extract with NaHCO<sub>3</sub>, get the pH to 7 and dry. Chromatograph on 200 g silica gel as above or distill and collect the fraction at 130° with 0.001 mm vacuum.

*Olivetol*. 3,5-Dimethoxybenzyl alcohol. (This can be made by reducing 3,5-dimethoxybenzoic acid, or it can be purchased.) (10 g) in 100 ml of methylene chloride is cooled to 0° and 15 g of PBr<sub>3</sub> is added. Warm to room temp and stir for 1 hour, then add a little ice water followed by more methylene chloride. Add petroleum ether to precipitate the benzyl bromide, which is separated off. 9.3 g of the benzyl bromide is put in a flask with 800 ml of dry ether and then add 15 g of copper iodine at 0°. Add butyl lithium (16% in hexane) and stir for four hours at 0°. Add saturated NH<sub>4</sub>Cl and extract with ether. The ether is removed by evaporating in vacuo to give the olivetol dimethyl ether which must be demethylated by one of the methods given in the above formulas. Yield: A little over 4 g. Taken from HCA, 52, 1132.

*Olivetol*. JOC, 42, 3456 (1977). This is an easy, modern, and effective formula giving excellent yields in large quantities. It begins with two intermediates, one from a Russian journal.

*3-Nonen-2-one*. J. Gen. Chem. (USSR), Vol. 33, p. 134 of the English translation. Oxidation of the ketone is accomplished in this manner: 0.5 mole of n-hexylideneacetone (this should be freshly distilled at 93-95° with 16 mm of vacuo) is shaken in an oxygen atmosphere at 30° for 8 hours. Decompose the hydroperoxides with a little sodium sulphite. Fractionally distill in three steps; about 40° at 16 mm vacuo, 93-95° at 16 mm vacuo, and the product is obtained by reducing the vacuum to 1 mm and raising the temp to 107-108°. Yield of pale, yellow, viscous liquid, 6 g. The unreacted starting material (93-95° @ 16 mm) is used over and over until reacted.

*Methyl 6-n-pentyl-2-hydroxy-4-oxo-cyclohexenecarboxilate*. JOC, 42, 3456. To a solution of 32.5 g of sodium methoxide and 90 g of dimethyl malonate in 230 ml of dry methanol, is added

portion wise with stirring 75 g of 3-nonene-2-one. Reflux this mixture for 3 hours under a nitrogen atmosphere and allow to cool to room temp. The solvent must be removed by distillation under vacuo and the residue is dissolved in 350 ml of water. A slurry of white crystals and the clear solution are extracted with chloroform (3 times 80 ml). Acidify the aqueous to a pH of 4 with coned HCl acid and let the precipitate stand for over 12 hours before filtering. Dry the crystals at 35-45° under a high vacuum. Yield: 106 g, nip: 96-98°.

*Olivetol*. JOC, 42, 3456. To an ice cooled solution of 58.5 g of the above product dissolved in 150 ml of dimethylformamide is added dropwise with stirring a solution of 38 g of bromine (dissolved) in 60 ml of dimethylformamide over 90 minutes. Heat slowly to 80° and maintain until the carbon dioxide evolution stops. Heat is raised to 160° for 10 hours. Remove the dimethylformamide by heating under reduced pressure and treat the resulting residue with 80 ml of water. Extract with two 250 ml portions of ether, then wash this ether solution with each of the following in separate installments; water, two 80 ml portions of a 10% sodium bisulfite solution, two 80 ml portions of 10% acetic acid solution, and again with water. Dry the washed ether solution with Na<sub>2</sub>SO<sub>4</sub> and remove the ether by heating under reduced pressure to get 46.5 g of a viscous oil, which is fractionally distilled to give 30 g of olivetol. Recrystallize from ether to purify.

*p-Menthadienol*. 136 g of (=) limonene and 2 g of bengal rose dye are added to 2 liters of methanol. Illuminate under a high voltage mercury light (a 6000 watt unit should be good enough) for 12 to 13 hours. Concentrate the methanol to about 500 ml at 0-10°. Stir with ice cooling and add the ethanol solution dropwise to a solution of 250 g of Na<sub>2</sub>SO<sub>3</sub> in 1<sup>1</sup>/<sub>i</sub> liters of water and keep stirring for 12 hours. After stirring for 12 hours, heat for 2 hours at 70°. Extract with ether, dry the ethereal solution as usual, and evaporate in vacuo to get almost 100 g of substance that contains about 40% menthadienol, which can be removed by fractional distillation. Collect the fraction that comes over at 34-36° with 0.1 mm of vacuum. This formula is a mixture of two references; Leibigs Annalen der Chemie, 674, 93 (1964) and Bulletin de la Societe Chimique France, 3961 (1971).

*p-Menthadienol*. TL, 2335 (1966). A solution of 136 g of delta 4 carene and 120 g of anhydrous sodium acetate in 330 ml of methylene chloride is cooled in an ice-water bath. With stirring add 167 g of 50% perchloric acid and stir for 10 more hours. Heat to boiling for 2 hours, cool, wash with water, then with sodium carbonate, again with water, and dry. Evaporate the methylene chloride in vacuo to get almost 100 g of product.

*p-Menthadienol*. JOC, 38, 1684 (1973). 3.6 g (32.4 mmol) and 75 g of (0.66 mol) of 30% hydrogen peroxide is added to a stirred solution of 80 g (0.6 mol) of (+)-limonene in 100 ml of tetrahydrofuran. The mixture is heated until a vigorous reaction begins. After the reaction begins to subside (about 10 min) the mixture is heated to reflux. Reflux for 4 hours, remove the solvent (tetrahydrofuran) by heating to 30° at about 1 mm pressure. Remove the unreacted limonene (save for another batch) by heating to 40° at 1 mm pressure. The menthadienol can now be removed (and purified in the process) by distilling at 34-36° under 0.1 mm of vacuum.

*p-Menthatriene (1,5,8)*. BER, 89, 2493. 90 g of d(+)-carvone in 150 ml dry ether are mixed in a flask equipped with a mercury sealed stirrer and an addition funnel. Add dropwise with good stirring; 7.5 g of LAH in dry ether. Heat for 1 hour on water bath, cool and slowly add water to decompose excess LAH. Add ice cold dilute sulfuric acid, let set, separate the ether and extract the aqueous layer with ether. Combine the ether layers, dry, and evaporate in vacuo to get 60 g of p-menthatriene.

(-) *Verbenol*. JCS, 2232, (1961). Add 27 g of alpha-pinene to 500 ml of dry benzene to a flask that is equipped with a good stirring device and heat to 63°. Add with stirring; 84 g of lead tetra-acetate over a period of 20 min and stir for another 30 min after the addition, while still maintaining the temp at 63°. Cool, filter and add filtrate to water. Filter again and evaporate the benzene layer in vacuo to get 21 g of cis-2-acetoxy-pin-3-ene. 5 g of the above product is added to 25 ml of cooled (20°) glacial acetic acid and this mixture is held at 20° for 30 min, then add water and extract with ether. Wash the extract with Na<sub>2</sub>CO<sub>3</sub> and evaporate the ether in vacuo to get 4 g of trans verbenyl acetate. This acetate is then hydrolyzed by treating with sodium hydroxide to give (-) cis and trans verbenol.

*4-Carbethoxy-1-Methyl-Cyclohexanone*. LAC, 78, 630 (1960). This is used to produce delta-3 THC (which is legal in a few states) by substituting it for menthadienol in several formulas given later. It may also work in some of the formulas that are designed specifically for menthadienol or verbenol by replacing them with an equimolar amount of it. I am not sure exactly which states allow what THC analogs, so it is up to you to find out. The last I heard, in Alaska it was legal to grow and possess all cannabinoids, and Oregon was trying like hell to follow suit. Would this type of legislation allow the making of your own THCs? Or has your state outlawed every THC analog? Ask a lawyer.

Add 20 g of clean sodium metal to 325 ml of cooled (-16°) dry ethanol. Add 100 g of 3-methyl-cyclohexanone in small amounts over a period of 1 hour and 150 g of diethyloxylate while keeping the temp below -11°. Maintain this temp for 3 hours, then 12 hours at room temperature. Make a solution of 1.3 liters of water and 60 ml of 2 N sulfuric acid and add this to the reaction mixture. The resulting yellow brown oil is separated and the water is extracted with ether until the yellow color is removed. Combine the oil and the extracts and distill off the solvent and unreacted starting material at 100° with 13 mm of vacuo. Slowly heat the residue to 220° and hold there for 90 min. Fractionally distill 2 times to get a little over 80 g of colorless oily product.

*1,2-Dimethyl-Heptyl Resorcinol* TET, 23, 77 (1967). According to R. Adams (JACS, 70, 664 (1948), who made this resorcinol back in 1948, it makes a THC 70 times more powerful than the naturally occurring THC when tested on dogs, and is 500 times more potent than natural THC when tested on rats (JMC, 16, 1200 (1973). To come up with the 1,2-dimethyl-heptyl resorcinol, the formula given in the reference must be changed by replacing 2,4-dimethoxy-acetophenone with 3,5-dimethoxy-acetophenone.

Make a suspension of 24 g of clean magnesium ribbon (or thin magnesium chips) and 1 small crystal of iodine in 100 ml of absolute ether. Add dropwise, with good stirring under an atmosphere of nitrogen, a solution of 180 g of 2-bromoheptane in 100 ml of absolute ether over a period of 1 hour. After the addition, heat under reflux for 2 hours and add a solution of 3,5-dimethoxyacetophenone in 200 ml of tetrahydrofuran over 4 hours. Reflux for 10 hours after the addition is complete. Cool, and add 180 ml of saturated aqueous ammonium chloride to decompose the unreacted Grignard reagent. Filter or decant off the solvent and extract the residual paste with tetrahydrofuran and combine all the solvents (tetrahydrofuran is a solvent too) and dry with calcium chloride. Evaporate the solvents in vacuo and distill the residue at a pressure of 10 mm and at an oil bath temp of 120-130° after adding 3 or 4 drops of 20% H<sub>2</sub>SO<sub>4</sub>. The residue is redistilled on an oil bath, which has a temp of 285° under 0.2 mm vacuum. The fraction boiling at 128-140° (0.2 mm) is collected to yield 60 g. Redistill at about 215° at 0.2 mm.

A solution of the above octene (50 g) in 100 ml of ethanol is shaken under 2-3 atmospheres of hydrogen in the presence of 0.6 g of 10% palladium-carbon catalyst, until no more hydrogen

is taken up (around 2 hours). Filter off the catalyst and evaporate the filtrate under vacuo. The resulting residual colorless oil is distilled with 0.1 mm of vacuo to give 42 g, boiling at 110-117°.

The above methyloctane is demethylated as follows. Mix 40 g of the above product with 100 ml of 48% hydrogen bromide and 320 ml of glacial acetic acid. Heat under reflux for 4 hours, and pour onto ice. Add portions of 10 N sodium hydroxide to the mixture until you get a pH of 4 to 5, then extract with ether. The ether extracts are combined, and extracted with three 150 ml portions of 2 N NaOH. These extracts are combined and acidified with acetic acid, which is then extracted with ether. Dry the combined ether extracts with  $MgSO_4$  and evaporate under reduced pressure (vacuum) to remove the ether. Distill the residue, collecting the fraction boiling at 158-160° at 0.1 mm vacuo to get 20 g of dimethyl-heptyl resorcinol. This demethylation may be used on olivetol dimethyl ether to demethylate.

*1,2-Dimethyl-Heptyl Resorcinol*. German patent 2,2002,815 (1970). You may use this reference with 3-nonene-2-one (synthesis given above) to make olivetol. This would be easier than producing the 5,6-dimethyl-undec-3-ene-2-one required for dimethyl-heptyl analog, but the loss in activity would be great. Add an excess amount of acetone to 2,3-dimethyloctanol and condense in the presence of sodium hydroxide in benzene at 20-60°. Distill under reduced pressure and reflux in benzene to dehydrate.

Mix 230 ml of dry ethanol with 32.5 g of sodium methoxide under a nitrogen atmosphere until the methoxide is dissolved. Add 110 g of diethyl malonate and stir for 10 min, then add 75 g of 3-nonene-2-one (or equimolar amount of 5,6-dimethylundec-3-ene-2-one for dimethyl-heptyl) keeping the temp below 49° with external cooling. Stir and reflux for 3 hours, cool to room temp, neutralize with coned HCL acid (about 45 ml), and let stand for 8-12 hours. Evaporate in vacuo, and dissolve the residue in 1 N HCl acid and 800 ml ethylacetate. Allow to stand to separate the ethyl acetate, then wash it (the acetate) with two 300 ml portions of water and extract with a saturated solution of  $NaHCO_3$  until a small sample shows no turbidity upon acidification (it will take at least nine 100 ml portion extractions). Combine the  $NaHCO_3$  extractions and very carefully acidify them with tiny portions of acid. Extract with three 300 ml portions of ether, and remove the ether by evaporation in vacuo after drying with  $MgSO_4$  to get the methyl-carboxylate.

4.8 g of the carboxylate is dissolved by stirring in 100 ml of glacial acetic acid (this requires vigorous agitation) at 75°. Cool and maintain temp at 5-10° while adding a solution of bromine (4 g) in 10 ml of glacial acetic acid dropwise over an hour. Stir for 1 hour, after the addition is complete at room temp, and then stir for 3 hours on a steam bath. Evaporate in vacuo and dissolve the remaining residue in ether (200 ml). Wash with two 25 ml portions of 10% sodium dithionite, then two 25 ml portions of a saturated solution of  $NaHCO_3$ , and then with water. Dry as before and evaporate in vacuo. Distill with 0.05 mm of vacuo and collect the portion coming over from 125-130° to get olivetol or analog.

## ***TETRAHYDROCANNABINOL***

The synthesis of THC is very easy. As you have probably noticed, the precursors to make THC are quite a bit more difficult. Still, they are not hard enough to baffle anyone with a little common sense, and as olivetol is closely watched by drug enforcement agencies it is much safer to make your own. There are many analogs of THCs that have not been outlawed by legislation and that have considerable activity. There are some excellent books written on the effects of different THCs

(see recommended reading). These books are accurate, informative and meaningful, but they are quite thick and as my space is limited, I cannot pass this information on to you. You will have to get the material on your own and this should be easy because the reading can be found at most any library. After finding a compound that suits your needs, check with a lawyer or have a friend call a law organization to see if it has any adverse laws controlling it.

The precursors given above vary in potency, but are versatile with the ability to be used in place of one or the other and still produce an active compound. Yields may suffer somewhat from this interchanging of precursors, but if an equimolar amount is used this should be minimal. When researching THC's, remember that there are different methods of numbering the molecule and this will depend on who has written the material that you are reading. For a brief report on structure activity relationships see JMC, 16, 1200 (1973) and also Chemical Reviews, 76, 75 (1976).

This first formula is a simple one-step method giving a good yield of delta 1 THC. JACS, 96, 5860 (1974). This is so simple, that I can't help but imagine how easy it would be to get olivetol and menthadienol using the fake identification and travelling method, and make a fortune by spraying bales of hay with the product, thereby making extremely potent smoke for about \$10 a pound.

*THC.* A mixture of 2.9 g of olivetol (or analog) and 2.5 g of (+)-cis/trans-p-menthadienol, and 2 g of anhydrous magnesium sulfate is stirred with 100 ml of methylene chloride under a nitrogen atmosphere. After cooling in an ice bath, 1 ml of freshly distilled  $\text{BF}_3\text{-Et}_2\text{O}$  is added. The mixture is stirred for  $1\frac{1}{2}$  hours at  $0^\circ$  and 5 g of anhydrous sodium bicarbonate is added and stirred until the color fades. The reaction mixture is filtered and evaporated to give 5 g of a colorless gum containing 50% delta 1 THC. I feel that if this is to be used by smoking it does not need to be purified further, however, this is the process for complete purification: 3 g of the above gum is chromatographed on 150 g of 100-200 mesh Florisil that is packed in a 1 inch by 36 inch column in petroleum ether at  $30\text{-}40^\circ$ . Elute with graded mixtures up to 2 parts ether to 98 parts petroleum ether to yield .75 g of pure product.

If you carry out the above reaction without the magnesium sulfate, the product is a combination of 27% delta 1 THC and 25% delta 1 (6) THC. If carried out this way at room temp the product is 51% delta 1(6) THC which is close to the same in potency as delta 1 THC.

*THC.* 4.7 g of olivetol (or analog) and 4 g of (+)-menthadienol and 0.8 g of p-toluenesulphonic acid in 250 ml of benzene are refluxed for 5 hours, after any exothermic reaction has begun to subside. Cool, add ether, wash with  $\text{NaHCO}_3$  and dry. Evaporate in vacuo to get a little over 8 g of crude product. Purify by chromatography on 350 g of silica gel in a column 1 inch by 6 feet in petroleum ether. Elute the THC with several portions of benzene. Elute an inactive product with 98% benzene and 2% ether. Elute the unreacted olivetol with 50% benzene and 50% ether and reuse in next batch. Yield of purified product about 4 g.

*Note:* The two methods of purification above can be used on any of the formulas for THC to purify and recover unreacted chemicals.

*THC From Verbenol and Olivetol.* 100 g of (-) verbenol is mixed with 50 g of olivetol (or analog) in 8M> liters of methylene chloride by stirring. Cool to  $-10^\circ\text{C}$  by using suitable freezing mixture (given in equipment chapter) and add 850 ml of  $\text{BF}_3\text{-Et}_2\text{O}$  under a slow stream of nitrogen atmosphere, taking care not to let the temp rise above  $-10^\circ$ . Continue stirring for 2 to 4 hours at  $-10^\circ$  and evaporate to get 50% yield. *Note:* Reagents should be dried with calcium hydride and

distilled before use. This formula can be made on a smaller or larger scale with great success by dividing or multiplying all reagents. Temps stay the same, but the times involved may change. See JACS, 94, 6164 (1972). You may purify as above to get unreacted verbenol.

## ***RACEMIC THCs***

The formulas for racemic THCs are overshadowed by the procedures above because they are not really much easier, if at all, and their yields are considerably less. If you get the formulas from a journal, remember that the yield will actually be *1/2* that stated. In the procedures to follow, I have figured in the yield as the actual for you.

*delta-3 THC.* Mix 1 mole of pulegone with 1 mole of olivetol (or analog) and 0.3 mole of phosphorous oxychloride in 1000 cc of benzene and reflux for 4 hours. Cool to room temp and evaporate in vacuo to get crude product. If you require purified product, then do not evaporate, but do this: after refluxing, pour into an excess of saturated NaCHO<sub>3</sub> (sodium bicarbonate) and extract the unreacted olivetol with dilute sodium hydroxide. Separate the benzene layer and evaporate the benzene in vacuo to get the THC. Delta-3 THC is about 5 times weaker than delta-1 or delta-1(6) THC unless the olivetol has been substituted with 1,2-dimethyl-heptyl analog. To get maximum yield of the dimethyl-heptyl substituted THC, use the following formula, as it is designed specifically for this intermediate.

11.6 g of 1,2-dimethyl-heptyl resorcinol (or analog in equimolar ratio) are mixed with 9.2 g of 2-carbethoxy-5-methyl cyclohexanone (or equimolar amount of 4-carethoxy-1-methyl-3-cyclohexanone) and 5 g of phosphorus oxychloride in 70 ml of dry benzene. Boil for 5 min (protect from atmospheric H<sub>2</sub>O) noting the evolution of hydrogen chloride, then let stand for 20 hours at room temp. Pour into an aqueous solution of sodium bicarbonate (10%), separate the benzene layer and wash it with three 50 ml portions of 10% sodium bicarbonate solution. Dry the benzene, evaporate in vacuo, and recrystallize from ethyl acetate to get 6% g of the pyrone intermediate.

Make a solution of 4.5 g of the pyrone in 150 ml of benzene and add it dropwise to a solution of 7.8 g of clean thin strips (or ribbon) of magnesium, and 18 ml of methyl iodide in 90 ml of dry ether. Reflux for 20 hours and add 45 ml of saturated ammonium chloride. Separate the organic layer and extract the aqueous phase with the benzene. Combine the organic layer with the benzene extractions and dry. Evaporate the benzene off in vacuo to get the THC. TET, 23, 77 (1967).

*delta-3 THC.* Mix 7.5 g of dimethyl-heptyl resorcinol with 6.5 g of 4-carbethoxy-1-menthyl-3-cyclohexanone, 5.8 g of phosphorous oxychloride in 60 ml of dry benzene. Reflux for 5 hours, cool and pour into a saturated solution of sodium bicarbonate and work up as above to get over 6 g of THC. JACS, 63, 1971 (1941).

*Note:* When researching THCs on your own, remember that the different numbering systems create a need for the following information. Delta-1 THC is the same product as delta-1-3,4-trans THC and delta-9 THC. Delta-1(6) THC is the same as delta-8 THC and delta-6-3,4-trans THC. Both these compounds can be changed over into one or the other, but as they are of about the same potency, this is a waste of time and chemicals.

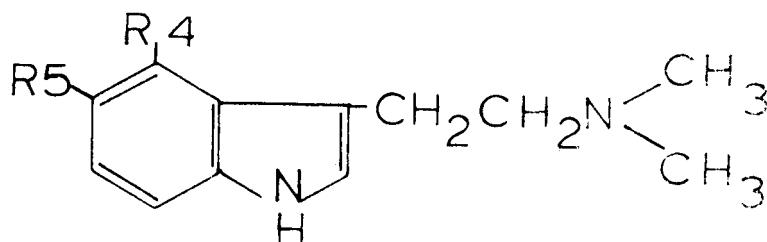
**INDOLE ETHYLAMINES**

DIMETHYLTRYPTAMINE.....R5 = H

BUFOTENINE .....R4 = H; R5 = OH

PSILOCYBIN .....R4 = OPO(OH)<sub>2</sub>; R5 = H

PSILOCYN .....R4 = OH; R5 = H

*Note:* These are only a few of many indole ethylamines that can be found in nature or synthesized synthetically.

Indole ethylamines are related to the neurotransmitter substance serotonin, which, unlike adrenalin, does not cause any behavioral changes after ingestion or injection. This is because it does not effectively penetrate the nervous system. A precursor of serotonin, 5-hydroxy tryptophan does produce elevated brain serotonin levels and excited or psychotomimetic type behavior. These serotonin relatives are one of the largest and most interesting of the hallucinogenic substance group around. There has been a great deal of research and testing done on the indoles, but unfortunately I could not find any done on humans, so many of the compounds you may run into in journals may have to be tested by yourself to ascertain the actual effects. I certainly do not recommend this, although many of the references given are from organizations doing research on indoles for the American Cancer Society. I feel indoles to be safe, but only careful, professional research can prove this.

I will try to cover only the synthesis of the known indole type derivatives known to be hallucinogenic. You may notice that the primary amine used in these syntheses may be substituted with many other primary amines, much like the reaction of lysergic acid with a primary amine in LSD formulas. The potencies of the primary amines used in LSD are not the same as for the indole derivatives. According to tests on animals, the duration and potency of indole derivatives are as follows.

On the next page are the primary amines. Potency can usually be enhanced further by putting acetoxy or methoxy groups in the R4 and R5 positions of the benzene ring.



These amines are listed in strong to weak potencies when used as substituents in most all formulas. Use an equimolar amount when substituting these amines.

1. Dimethylethylamine = Methylethyltryptamine
2. Diethylamine = Diethyltryptamine
3. Pyrrolidine = Pyrroltryptamine
4. Dipropylamine = Dipropyltryptamine
5. Dimethylamine = Dimethyltryptamine (DMT)

As you should know this is only a few of many primary amines. There are lots more that need to be used in a formula and tested for potency and duration.

The psychedelic effects of dimethyltryptamine are best described as overwhelming, extraordinary and extreme giving some of the most realistic, remarkable and far out visual, audible and physical hallucinations obtainable. Unfortunately, dimethyltryptamine hallucinations last a little under an hour and it is ineffective if eaten, so it must be sniffed or smoked (not very pleasurable). Some of the tryptamines (usually the more powerful ones) are active orally, such as psilocyn (5 mg) and last over 4 hours.

Many tryptamines and indole derivatives are legal in all states and can therefore be purchased from many chemical suppliers. Some will require a letter stating that you are a legitimate laboratory or business and that these products are not to be used for human consumption or illegitimate resale (see the buying precursors section). For an example, 5-methoxy-N,N-di-methyltryptamine can be purchased, with a statement, for about \$40 per gram from Aldrich and many others. The usual dose of this substance is 3 to 5 mg, giving 200 doses per gram. At a reasonable price of \$2 a dose, your profit will be \$360 per gram. Some people do not like the effects of this drug and personally, I feel the first 2 to 5 min are somewhat distressing, but then the effects soften into an LSD type of feeling, lasting for 30-40 min. These short duration tryptamines are referred to as the businessman's buzz, as they are snorted, like cocaine and their short duration allows them to be used during coffee breaks and lunch hours.

5-Fluoro-a-methyltryptamine is another tryptamine that can be ordered from Aldrich and many other chemical suppliers. This drug does not require a statement, as described above, and its effects are very pleasant (much like psilocyn). Also, it can be eaten instead of smoked or snorted. The major drawback here is the \$100 a gram price combined with the higher 25 mg oral dose. Smoking or snorting may increase the potency.

Other methylated tryptamines with similar action to 5-fluoro-a-methyltryptamine are; 6-fluoro-a-methyltryptamine, 7-methyltryptamine, N-methyltryptamine, 5-methyltryptamine. The dosages will also be much the same. Some non-methylated derivatives are claimed to be active, but I could not find dosage or explicit effects. They are; 5-fluorotryptamine, 6-fluorotryptamine, 5-and 6-fluorotryptophans. Alpha-methyltryptamine may be legal in some states and is claimed to give a 16 hour trip; with oral doses of 30 mg. Look for these tryptamines in Chemical Sources to find the supplier that sells them and call to get prices. Never ask them about the doses or effects in any correspondence.

Most of the indole ethylamines that you will run into are hallucinogenic. Many have analgesic properties, and others have both hallucinogenic and analgesic properties. As stated above, much

work has been done on the procedure of making these compounds, but little human testing for effects can be found.

Many of the formulas for indole ethylamines use indole as starting material or an indole type acid (indole-3-acetic acid), which are converted to tryptamine or directly to the active dialkyltryptamine or dimethyltryptamine. If your formula gives just tryptamine, then it will have to be converted to one of the active compounds. As usual I will give the intermediate formulas before getting into the active products. Indole and tryptamine can be purchased from many chemical suppliers, but they are watched very closely by the DEA.

*Indoles.* CA, 74, 87819 (1971). First prepare polyphosphoric acid by adding 2 parts  $P_2O_5$  to one part phosphoric acid. Add 3.3 g of phenylhydrazine and 4 g of phenylacetone (or an equimolar amount of ethylacetone) to 30 g of polyphosphoric acid and heat for 20 min at  $135^\circ$  in a nitrogen atmosphere. Pour over 200 ml of water and extract with dichloromethane (methylene chloride) to get 2-benzylindole in 43-47% yield. Ethylacetone gives 2-ethylindole in about 30% yield.

*Indole.* Russian patent 306, 126 (1971). *Note:* See the making precursors section of this book for an explicit method of producing methylindole in good yield. Add 26 ml of 0.77 N NaOCl to a stirred suspension of 1.9 g of orthocarbamoyl cinnamamide in 50 ml of methanol and heat in a distillation apparatus until no more indoles is distilled off (use an indole test) or just heat at  $40^\circ$  for 2 hours. Extract the distillate with chloroform, dry with most any drying agent, except calcium chloride, and evaporate the solvent ( $CHCl_3$ ) off from the remaining indole. Yield: 45%.

*5-OH-Indole.* To a solution of 4.3 g of 2,5-dihydroxyphenylalanine and 2 g of  $NaHCO_3$  in 150 ml of water is added, with stirring over 10 min a solution of 13 g of potassium ferricyanide and 3 g of  $NaHCO_3$  in 200 ml of water. After the dark solution turns a pale yellow, extract with three 200 ml portions of ether, dry as usual, and evaporate the solvent off in vacuo to get a little over 2 g of 5-OH-indole. This is from JCS, 2525 (1952).

*Indole-3-Acetic Acid.* Dissolve 21.6 g of phenylhydrazine in 300 ml 0.3 N sulfuric acid. To this solution add 9.8 g of coned sulfuric acid. With stirring and heating to  $100^\circ$ , add dropwise 11.6 g of methyl-beta-formyl-propionate in 300 ml of 0.3 N sulfuric acid. Continue the heating and gentle stirring for 6 hours to get about 14 g of indole-3-acetic acid. This is from CA, 72, 66815 (1970).

*Tryptamine.* CA, 79, 14632 (1973). This is a fast one step operation, giving a good 70% yield. Condensation of  $PhNHNH_2$  (phenylhydrazine) with  $C1CH_2CH_2CH_2CHO$  (n-butyryl chloride, 2-chloroethyl vinyl ether) in refluxing aqueous EtOH for 6 hours gives 70% tryptamine.

*Tryptamine from Tryptophan.* Prepare a suspension of 1 g tryptophan (preferably L-tryptophan) in 40 g of warm diphenylmethane. In a stream of nitrogen (nitrogen atmosphere) gently reflux the suspension until the  $CO_2$  stops evolving (10 to 30 min). Cool, evaporate in a vacuum, treat the resulting residue with about 80 ml of benzene, saturate with dry HCl and filter off the precipitate. Wash the precipitate with hexane and dry to get the tryptamine in about 60% yield.

*Tryptamine from Indole.* CA, 54, 13018 (1960). To 15.5 g of most any indole in 40 ml of dry ether, under a nitrogen atmosphere, add 50 ml of methyl magnesium bromide in 2% moles of dry ether and reflux for 15 min. Cool on ice bath and add 68 ml of ethyleneimine in 30 ml of dry xylene. Stir for IVi hours at  $65-70^\circ$  F (room temp) adding dry xylene, as needed, to maintain starting volume. Reflux for 1 hour and cool to room temp. Add 75 ml of water dropwise and add HCl acid slowly to give a pH of 1. Filter off the precipitate, wash with ether (cold) and then dissolve in 150 ml of hot water. Cool to  $10^\circ$  C for 15 min and decolorize in the usual

way. Filter, neutralize with 10 N NaOH (about 75-85 ml) and stir at 5° C. Filter and dry to get the title product.

*Tryptamine from Tryptophan.* JCS, 3993 (1965). Place 10 g of powdered tryptophan into 500 ml of diphenyl ether and reflux for 60 min under a nitrogen atmosphere. Cool and extract with three 40 ml portions of 2 N HCl acid. Wash the extract with ether, basify with 6 N NaOH and extract with five 50 ml portions of ether. Wash the extract with water and then with a saturated NaCl solution. Dry, evaporate in a vacuum and recrystallize from benzene to get the tryptamine.

When I refer to dialkyltryptamines, I am talking of the active compounds, such as DMT, DET, DPT, MET, etc. All these drugs can be classified as dialkyltryptamines, you decide which drug will be created by substituting the desired amine.

*Dialkyltryptamines from Tryptamines.* Bull. Chem. Soc. Jap. Vol. 11, 221 (1936). 1.5 g of tryptamine is mixed by gentle stirring with 30 ml of ethanol (dry). Add 5 g of methyl iodide and 4.5 g of dry sodium carbonate and heat five hours (just below reflux temp) on a water bath. Filter hot, heat precipitate with ethanol and filter hot again. Evaporate the ethanol off in vacuo to get about 2<sup>1</sup>/<sub>4</sub> g of 1-methyl-DMT or analog.

*Alpha-Methyl-DET from Indole.* JMC, 9, 343 (1966). 46.8 g of indole in 100 ml of toluene are added to 54.5 g of ethyl bromide and 12.5 g of freshly cleaned magnesium ribbons (or thin turnings or fine chips) in 125 ml of dry ether. Allow to set for 30 to 50 min and add 25 g of propylene oxide in 100 g of anhydrous benzene over 50-60 min. For two hours, the temp is maintained at 0-5° with stirring. Let the mixture set until it reaches room temp and then distill off the solvents over a period of 5 hours. Add 8.8 g of the residue to 200 ml of ether, add 4.4 g of PBr<sub>3</sub> and let stand for 4 hours. Add excess diethylamine (8g is more than enough) or analog and mix gently for a short time (15 min). Extract the organic layer with dilute acid (HCl or sulfuric) and liberate the tryptamine product from the combined extracts by adding small portions of a strong base (NaOH or ammonium hydroxide). Distill the precipitate, collecting the fraction at 165° with 1.5 mm of vacuo to get 1.8 g of pure product.

This same reference (immediately above) also gives the formula for making the same drug in a different manner, it follows.

*a-Methyl-DMT or DET or Analog.* JMC, 9, 343 (1966). A solution of 46.8 g of indole in 100 ml of dry toluene is added to a Grignard reagent prepared from 54.5 g of ethyl bromide and 12.5 g of magnesium turnings (clean always) in 125 ml of dry ether. After 30 min (when the magnesium has dissolved) treat the solution with 63.5 g of a-chloropropionyl chloride in 50 ml of toluene. After 1 hour of stirring, pour the mixture into ice-water NH<sub>4</sub>Cl solution, shake briefly, allow to set until the layers separate. Remove the organic layer, dry it, and evaporate the solvents in vacuo. Recrystallize from ethanol to get 16 g of intermediate #1. Reflux 4.5 g of #1 with 10 ml of dimethylamine (or equimolar amount of analog) in 100 ml of ethanol for 1 hour. Concentrate the solution by evaporating in vacuo, acidify, and extract with ether, and the aqueous layer is rendered alkaline. The precipitate is filtered and recrystallized from ethanol to give 2.6 g of intermediate #2, which has a melting point of 192-193°. A solution of #2 (3 g) in 50 ml of tetrahydrofuran (THF) is added to 3 g of LiAlH<sub>4</sub> in 60 ml of THF and refluxed for 2 hours. Add H<sub>2</sub>O until bubbling stops, filter, dry and evaporate in vacuo to get product.

Obviously, this second method is the better of the two in ease, simplicity, and speed. Given below is another way to get virtually the same product. This method was also taken from JMC, 9, 343 (1966). It begins with a starting material called 3-indolyl acetone, given is one way to make this substance, see JCS, 3172 (1952) for another formula.

*N,a*-DMT. JMC, 9, 343 (1966). Mix 5.5 g of indole, 15 ml of cyclohexane, and 0.5 g of clean copper. Bring this mixture to a reflux and add 2.9 g of diazoacetone dropwise. After some time, the reaction goes very rapidly and forms two layers. Filter, evaporate in vacuo to get 2<sup>1</sup>/<sub>2</sub> g of 3-indoyl-acetone. 3.3 g of 3-indoyl-acetone in 100 ml of ethanol is then reduced in the presence of an excess of methylamine (3 g), or analog, over palladium carbon catalyst (see the reductions chapter). After 2 hours the catalyst is filtered off and the solution is concentrated, acidified, extracted with ether, and the aqueous layer is made alkaline. The title product precipitated is a tan solid (2.2 g) with a melting point of 93-94° and can be recrystallized with a mixture of THF-hexane.

To reduce 3-indoyl-acetone to the active product with LiAlH<sub>4</sub>, just replace the above intermediate #2 with 3-indoyl-acetone and proceed as described. Many of the reductions (Raney Nickle, zinc, etc.) listed in the reductions chapter may also work.

*Dialkyltryptamines*. JCS, 7175-79 (1965). First the tryptamine must be methylated as follows. Dissolve the tryptamine in ether (methanol also works and is cheaper), add 2.5 g of diazomethane (careful, this is nasty stuff; see the making precursors chapter for synthesis and hazards) in ether and heat for 20 hours on oil bath. Evaporate in vacuo to get product.

6.3 g of the N-methyltryptamine is added to 40 ml of methylformate. Put this mixture in an autoclave (you may use medium or high pressure hydrogenation apparatus, as shown in the reductions chapter, if you use an explosion proof, steel box to hold the apparatus as it may explode; also check the apparatus carefully for cracks, bulges, etc. before using again) and heat for 6 hours at 100°. Cool and evaporate in vacuo to get about 1<sup>1</sup>/<sub>2</sub> g of precipitate. Dissolve this precipitate in 50 ml of THF and add to 2.5 g of LiAlH<sub>4</sub> in 50 ml of THF and reflux for 3 hours. Carefully add small portions of water until the bubbling stops, dry, evaporate in vacuo to get DMT. *Note*: Never use CaCl as a drying agent in the presence of amines or amides.

*Dialkyltryptamines from Tryptamines*. Helv. Chem. Acta, 49,1199 (1966). Heat 82 ml of acetic anhydride with 35 ml of formic acid for 2 hours at 60°. With stirring add dropwise a solution of 100 g of tryptamine in 250 ml of THF. After the addition, cool to room temp (slowly) and let stand for 12 hours. Evaporate the solvents off in vacuo and add water (cold) to precipitate oily formyl tryptamine, which is separated and recrystallized in the minimum amount of aqueous (50%) ethanol (the minimum amount will be under 750 ml). 35 g of the recrystallized formyltryptamine is added to 150 ml of THF and mixed gently and then added to 20 g of LAH (lithium aluminum hydride) in 400 ml of THF. After this addition (which is made dropwise) reflux for 12 hours. Cool to 15° and add 10 ml of water (when decomposing LAH with water or alcohol always add it slowly, dropwise and be careful), then 10 ml of 15% NaOH, and about 30 ml more water or until the bubbling has stopped. Filter, wash the precipitate off with a little THF and evaporate (the filtrate) in vacuo to get the dialkyltryptamine (about 20 g). Recrystallize the residue in about 100 ml of dry methanol and reprecipitate by adding 10 g of anhydrous oxalic acid.

*Dialkyltryptamines from 3-Indole-Acetic Acid*. Col. Czech. Chem. Com. There are several other methods given with this formula but they are not as good as the one given below. If you do not have a big, complete library, then you may need a translator to understand this and some of the other foreign journals.

Put 6 g of indole-3-acetic acid into 250 ml of ether and add 3 g of piperidine (or any other equimolar amount of suitable primary amine) in 20 ml of ether. Mix gently for a little while and allow to stand to form precipitate. After all the precipitate has formed, filter it off and heat 7

g of it at 190-215° for 3<sup>1</sup>/<sub>i</sub> hours. Cool and dissolve in 100 ml of ether. While dissolved in the ether, wash with 10% potassium carbonate, then with 5 N HCl acid and evaporate in vacuo. Add one gram of the residue in 25 ml of ether to 1.4 g of LAH in 50 ml of ether. Stir for 4 hours and then reflux for 30 min. Cool and slowly add water until the bubbling stops. Add 3 ml of 20% NaOH, dry, and evaporate in vacuo to yield about 1 g of dialkyltryptamine.

The next two drugs are several of the most potent dialkyltryptamines known to me. Their synthesis is not much harder than the formulas already given. They are made very easily from 5-acetylindole, which can be purchased or made for you by many chemical suppliers. Ordering is somewhat suspicious, so I will also give the formula for total synthesis of 5-acetylindole. There are many other drugs given on this same reference (JMC, 7,144 (1964), but some of them caused unwanted side effects in the dogs they were tested on (respiratory failure), so I did not include them.

*5-Acetylindole.* (Bulletin of the Chemical Society of Japan.) Put 2 g of indole in 50 ml of nitrobenzene and add 4 g of AlCl<sub>3</sub> in 50 ml of nitrobenzene. Add 1.25 g of acetyl-chloride and heat for 3 hours at 50°. Evaporate in vacuo and recrystallize the residue in ethyl acetate to get the acetylated indole.

*Note:* This is a general formula that should work on most all indoles. It may even work on tryptamines and dialkyltryptamines.

*5-Acetylgramine.* This substance is active (I.V. in mice) at doses of 5 mg per kg and less, making it quite potent. It potentiates response to DMPP (1,1-Dimethyl-4-phenylpiperazinium iodide) and blocks response to acetylcholine and adrenalin. Reflux a mixture of 15 g of 5-acetylindole or analog (in equimolar amount), 7.55 g of 37% aqueous formaldehyde, 17 g of 25% aqueous dimethylamine, 25 ml of acetic acid, and 250 ml of methanol for 3 hours. Concentrate in vacuo to 20% of original volume, treat with 100 ml of water, wash with chloroform, chill in freezer, and make basic with 20% NaOH. Filter off the crystalline precipitate and wash with cold (near freezing) water to get a little over 17 g of the title product. Recrystallize from benzene to purify. It is unknown to me if this is active orally.

*5-Acetyl-3-piperidinomethylindole.* A solution of 5 g of 5-acetylgramine in 125 ml of piperidine is refluxed for 2<sup>1</sup>/<sub>2</sub> hours and concentrated in vacuo. The oily residue is crystallized by trituration, with petroleum ether to give a little over 5 g of product, which is recrystallized several times from benzene to purify. Although this substance is less potent than 5-acetylgramine, it is much less toxic; making the lethal dose much larger.

There are other ways to make these two compounds. One of the intermediates is five times more potent than 5-acetylgramine and less toxic than 5-acetyl-3-piperidinomethylindole, so I will also give this method. This method starts from scratch, so it is not necessary to have indole as a starting material.

*Ethyl-a-Keto-y-dimethylaminobutyrate p-Acetylphenylhydrazone.* (JMC, 7, 144 (1966)). 40 g of p-aminoacetophenone in 250 ml of water and 143 ml of coned hydrochloric acid is diazotized at 0-5° with 21 g of sodium nitrite in 200 ml of water. To the resulting solution is added 60.3 g of ethyl a-(2-dimethylaminoethyl)aceto-acetate followed by 63 g of sodium acetate. Raise the pH to 6.5 and maintain with the addition of 3 N NaOH (also use the 3 N for the initial raise to 6.5). Stir, with external cooling for 2 hours, make basic, and extract with three 400 ml portions of chloroform. Combine the extracts and dry over sodium sulphate, concentrate in vacuo. Crystallize the residue with a mixture of benzene-petroleum ether, after purification with charcoal, to get 65 g. Crystallize two more times to get a melting point of 84-85°.

*5-Acetyl-2-carbethoxygramineHydrochloride*. This is the compound that is 5 times more potent than 5-acetylgramine. It can be used to make 5-acetylgramine, but this is not a wise thing to do, as you lose potency and gain toxicity. This substance does not block response to acetylcholine or epinephrine (adrenalin), so it may be interesting to do with another drug (THC). *Note*: Never do amphetamines or like drugs with a monamine oxidase inhibitor.

Make a mixture of 43 g of ethyl  $\alpha$ -keto- $\gamma$ -dimethylamino-butyrate p-acetylphenylhydrazone and 430 g of polyphosphoric acid and heat slowly with stirring. At 60-65° an exothermic reaction should be noticed with foaming (this will require you to have chosen a larger than normal reaction vessel). Raise the temp (gradually) to 102-109° and hold for 2 hours. Cool to 70° and pour the viscous solution into 700 ml of ice-water. Mix into complete solution with good stirring, make basic at a low temp, and extract with three 400 ml portions of chloroform. Combine the extracts and dry over sodium sulfate, then evaporate in vacuo. Add the residue to 150 ml of ethanol and mix into complete solution. Treat with ethanolic HCl and allow to stand overnight (12 hours). Filter off the precipitated salt and recrystallize from 95% ethanol. Yield: 37%, mp: 211-214°.

To convert this substance into 5-acetylgramine perform the following. A solution of 30 g of 5-acetyl-2-carbethoxygramine hydrochloride in 300 ml of acetic acid and 900 ml of 20% HCl acid is refluxed for 125 hours. Cool and filter off about 20 g of precipitate. Make the precipitate basic with a very cold solution of 40% KOH and extract with chloroform. Combine the extracts and dry as usual, then concentrate in vacuo. Recrystallize from benzene to yield 0.5 g of 5-acetylgramine. Mp: 142-144°.

As you may have noticed, the lousy yield and loss of potency hardly make this operation worth performing.

# ANALGESICS

Analgesics are drugs which relieve pain without producing unconsciousness. This is accomplished by the ability of these drugs to exert a central depressant action on the optic thalimi of the brain. Most of the drugs listed also create antipyretic effects, along with their analgesic properties. Other than excessive sweating, this should not cause a problem for the recreational drug user. Some of the other drugs, however, do not possess the antipyretic effects.

Morphine and its derivatives have been left out of this book because of the difficulty of their production. It is true that they are very powerful, but not worth the extra complexity and expense to reproduce synthetically when drugs such as methadone are easier and cheaper to make, more powerful, and have a longer duration of action.

Many of these drugs, like morphine, are very addictive and should be used with a great deal of caution. I feel that analgesic type drugs can be very pleasant, even to the extent of being fun. I also feel that analgesic drugs can be very dangerous, even to the extent of being fatal.

## CINCHOPHEN

*(Atophan, Quinophan, and Phenaquin are some other names for the same drug)*

*Pyruvic Acid.* Tartaric acid is distilled to 200° (all temps in centigrade, unless specified otherwise) on an oil bath, collecting all fractions. Redistill the distillate to yield pyruvic acid, by collecting the fraction coming over at 165°-170° only.

*Cinchophen.* (Method 1, U.S. Pat. 1, 676, 862.) A solution of 18.5 g of aniline, 21 g benzaldehyde, in 400 ml of ethanol is refluxed for 1 hour. Another solution of 8.9 g of pyruvic acid in 50 ml of ethanol is added and the boiling reflux is continued for another 1<sup>1</sup>/<sub>2</sub> to 2 hours. On cooling the cinchophen separates. To purify read below.

*Cinchophen.* (Method 2, Brit. Pat. 17, 725.) A solution of 150 parts isatin, 120 parts (most all formula using parts, refers to parts by weight) acetophenone, see the precursor section of this book for synthesis, and 200 parts 33% aqueous potassium hydroxide is refluxed for several hours. The solution, after boiling, becomes clear and is cooled. Dilute with water and precipitate the cinchophen by adding acetic acid. Mp: 213°-216° C.

Cinchophen has a tendency to produce severe liver damage and should be used with caution. Dosage, 300 to 600 mg with 2 to 5g sodium bicarbonate (baking soda) and a pint of water.

## **NEO-CINCHOPHEN**

(*Novatophan, Tolysin, Neoquinophan*)

This drug is synthesized like cinchophen, method one, above. The only difference is the starting material is p-toluidine instead of aniline. It is used for the same purpose as cinchophen, but is claimed to be much less toxic, even though the dosage is to be stopped after three days, just like cinchophen. The mp is 74° and the dosage is 300 to 600 mg, with baking soda and water taken in conjunction.

## **PHENAZONE**

(*Antipyrine, Analgesine, Sedatine, Paradine*)

*Ethyl Acetoacetate.* 250 g of ethyl acetate are shaken with a sodium carbonate solution, separated and allowed to stand for 23 hours over anhydrous calcium chloride. Filter and distill taking care to keep moisture or water from the reaction.

200 g of the purified ethyl acetate are placed in a 500 cc flask and 20 g of clean sodium metal (preferably in the form of wire) are added to the ester. Set the reaction up to reflux with precautions to exclude H<sub>2</sub>O. Warm gently on oil bath until reaction begins. If the reaction becomes vigorous, remove heat and introduce external cooling. After reaction subsides, heat at ebullition point for not more than 3 1/2 hours to dissolve the sodium. Cool and slowly acidify with around 100 cc of 50% acetic acid, testing often with litmus paper. Shake to dissolve the solids, and the mixture of ethyl acetate and ethyl acetoacetate is salted out by adding an equal solution of saturated brine. The upper layer of mixed esters is separated, washed with a cold saturated solution of sodium bicarbonate, dried over a small amount of dry calcium chloride, and fractionally distilled under reduced pressure. The fraction boiling at 85-95°/18 mm or 70-80°/40 mm is the product. Yield: 44 g 33% theoretical.

*Phenylhydrazine.* 10 g of freshly distilled aniline are added to a solution of 30 g coned hydrochloric acid in 75 cc of water and diazotized with 30 cc of water containing 8 g sodium nitrite, with external cooling below 5°. 30 g sodium chloride are added with very fast stirring and cooling of -5°. A solution of 60 g of stannous chloride in 25 g coned hydrochloric acid are then added and allowed to stand. Phenylhydrazine hydrochloride separates after 4-12 hours and is filtered off, washed with a saturated NaCl solution, treated with an excess caustic soda solution, and extracted with ether. The ethereal solution is dried with caustic potash, the ether is removed by evaporation, and the phenylhydrazine is purified by freezing or distilling in vacuo. Yield: 10 g 90% theoretical.

*Phenazone.* Equimolar amounts of phenylhydrazine and ethyl acetoacetate are heated for 8 hours at 125°. The resulting phenyl-3-methyl-5-pyrazolone is dissolved in anisole and heated to 135°. Methyl bromide is passed through (bubbled into) the solution for 10 hours at 135°, and the anisole is removed by steam distillation. Phenazone is extracted from the remaining residue with chloroform and the chloroform is distilled or evaporated off. The residue is recrystallized from ether. Mp: 111-113°. Dosage 300 to 600 mg. This drug also has antipyretic action (reduces fever) and can cause rashes, nausea, and fainting.



## **PHENACETIN**

*p-Nitrophenetole.* 140 g of p-nitrophenol are dissolved in 400 g of 10% caustic soda solution. This mixture is placed in a glass or enamel lined autoclave equipped with a stirrer or agitator and then mixed with 70 g of ethyl chloride. This is heated and stirred for 7 to 8 hours at 90-100°. Cool, filter the p-nitrophenetole off, wash with dilute caustic soda solution, and then wash with water.

*p-Phenetidine.* 100 g p-nitrophenetole, 200 cc of water, and 10 cc of coned hydrochloric acid are placed in a flask equipped with a stirring device and heated to 60°. 100 g of clean (see the reduction section of the amphetamines chapter to understand the preliminaries for an iron reduction) iron filings are gradually added (over 3 to 4 hours) keeping the temp at 60°. After the iron has been added the temp is raised to 90° and held there until the reduction is complete. The aqueous liquor is poured off, and the remaining sludge is steam distilled, with superheated steam, at 160-180°. The p-phenetidine distills over and is removed from the distillate by extraction with ether. Purify by distilling the ethereal solution.

*Phenacetin.* Mix equal weights of freshly distilled p-phenetidine and glacial acetic acid. **Heat** under reflux and add a little sodium acetate until no free base remains (diazotize and test with alkaline B-naphthol). Remove the unreacted acetic acid by distillation in vacuo and dissolve the residue in boiling water containing a little decolorizing charcoal. Upon cooling, phenacetin precipitates out and is filtered, washed, and recrystallized from water/ethanol using a little sulfur dioxide to prevent oxidation (sulfur dioxide solution being added to the recrystallization step).

Phenacetin is an important analgesic being used to relieve headache, neurotic pains and rheumatism. The drug also dilates the cutaneous vessels and depresses the heat control mechanism centered in the hypothalamus of the brain. This causes temperature decrease, accompanied by profuse sweating, giving the drug outstanding antipyretic capabilities. It is well tolerated and gives few, if any, side effects. Large doses do not lead to collapse, but may cause sweating in a person with a normal temperature. Dosage: 300 to 600 mg, mp: 134-136° C.

## **PETHIDINE**

*(Demerol, Dolantin, Meperidine, Isonipecaïne)*

*Isonicotinic Acid Methochloride.* To a slurry of 246 g of isonicotinic acid in 3.2 liters of methanol and 300 ml of water containing 88 g of sodium hydroxide has 355 g of methyl iodide added to it. *Note:* Isonicotinic acid can be replaced with nicotinic acid, thus producing B-pethidine, instead of demerol. There is very little difference in potency between these two drugs and the formula does not change (Oust use an equimolar amount of nicotinic acid), so you may use either acid. Stir and reflux the above mixture for 60 hours, then remove the methanol with vacuo. Use sodium thiosulfate to reduce iodine to iodide and add water to give a volume of 1.5 liters. Use hydrochloric acid (coned) to get a ph of 2.0.

Place a slurry of Amberlite IRA-400 (6.30 equivalents) in a glass tube 10 cm in diameter and 100 cm high. The resin is washed with 20 x 1. of 5% hydrochloric acid followed with 40 x 1. of distilled water. The yellow aqueous solution is passed through the column and the effluent, which had better be iodine free, is collected at a rate of flow of 50 ml per min. Three and one

half liters of effluent is coned and the residue is dried and extracted with acetic acid. Xylene is added to the hot acetic acid solution, then cooled, and saturated with dry hydrogen chloride to give 336 g of crude product. Recrystallize from acetic acid to purify.

*l-Methyl-4-carboxypiperidine Hydrochloride.* Isonicotinic acid methochloride is quantitatively reduced in a high pressure reaction vessel in the presence of platinum oxide in methanol at 1,000 psi, mp: 231-232°. (No specifics were given in this step. To get a good reduction; see the reduction section of the amphetamines chapter and use an equimolar amount of isonicotinic acid in place of the amphetamine precursor in the formula chosen. If high pressure equipment is unavailable another reduction may be substituted that uses atmospheric pressure.)

*Note:* The above two steps are somewhat difficult and can be omitted by purchasing 1-methyl-4-carboxypiperidine hydrochloride from a reputable chemical supplier.

*l-Methyl-4-benzoylpiperidine.* A mixture of 1-methyl-4-carboxypiperidine hydrochloride (135 g) and 200 ml of thionyl chloride is refluxed for 6 hours. After the excess thionyl chloride is removed, 800 ml of dry benzene is introduced to form a slurry. 267 g of anhydrous aluminum chloride is added with constant stirring over a period of 20 min. The dark brown mixture is stirred for an additional *fa* hour and then is poured onto 2.50 l. of crushed ice. With cooling, add enough 50% NaOH solution to make basic, while stirring. Separate the benzene phase and extract the aqueous phase with ether. The benzene and ether solutions are combined and extracted with six 300 ml portions of 5% hydrochloric acid. This acid extract is adjusted to 11 ph with NaOH and reextracted with ether. The ether solution is dried over sodium sulphate, filtered, and evaporated to a dark, reddish brown oil. This oil is fractionally distilled to collect a light yellow oil passing over at 122° at .5 mm. Crystallization from Skelly A produced the title product.

Dissolve the above product in ether, pass hydrogen chloride (dry) through the solution, and recrystallize the resulting salt from acetone, mp: 208-209°.

*l-Methyl-4-chloro-4-benzoylpiperidine Hydrochloride.* Chlorine gas is slowly passed (bubbled) into a solution of 48 g of the above product in 500 ml of glacial acetic acid for 8 hours at 70°. The volume is evaporated to 150 ml and 1 liter of dry ether is added. The resulting white powder is recrystallized from chloroform, yielding 45 g of the hydrochloric salt, mp: 181° to 182°. This is then recrystallized from Skelly A, mp: 48-49°.

*Rearrangement of l-Methyl-4-chloro-4-benzoylpiperidine.* Add 50 ml of xylene (containing 3.5 g of the above product) to a stirred refluxing solution containing 200 ml dry xylene and 18 g of finely powdered, dried sodium NaOH. Stir while refluxing for 30 min, then cool, extract with 25 ml portion of water until the ph of the extracts reaches neutrality (approximately).

The combined water extracts are washed with three 25 ml portions of ether and adjusted to 8 ph with hydrochloric acid. The aqueous solution is concentrated to 50 ml (by evaporation in vacuo), filtered, and acidified to 6.5 with hydrochloric acid. The solution is cooled and the crystals are washed with water, acetone, ether, and then dried. Recrystallize from water to get fine, white needles of 1-methyl-4-phenyl-4-carboxypiperidine. Yield: .8 g, mp: 309-310°. This product is then dissolved in ether and treated by passing dry hydrogen chloride through this solution and recrystallizing the resulting salt from acetic acid-benzene.

Take the above hydrochloride salt and reflux it in ethanolic hydrogen chloride to get Demerol or analog.

## METHADONE AND ANALOGS

(Amidone, Methyilmorphine, Dromoran)

Morphinans came about from early attempts at the total synthesis of morphine by a German chemist named R. Grew. Containing the complete carbon-nitrogen skeleton of morphine they are the closest chemical relatives which have been obtained by total synthesis.

### Amidone (From 2,2-Diphenyl-4-Dimethylaminopentanenitrile)

*Diphenylacetoneitrile.* 1 mole (117 g) of benzyl cyanide is placed in a 500 ml flask (preferably round bottomed) fitted with a stirring device (preferably glass and not steel), a dropping funnel, an air condenser, and a thermometer. Heat the cyanide to 106-109°, and with good stirring, add over 1 hour, 175.9 g of bromine. Keep the reaction components this way for 15 min after the bromine addition, then replace the dropping funnel with a gas inlet tube and pass dry nitrogen through the reaction apparatus for 30 min. Remove the hot mixture from the reaction flask and rinse thoroughly with 100 ml of benzene. Add this 100 ml rinse to the reaction mixture and add them to a stirred, boiling mixture of 368 g (4.7 mole) dry benzene and anhydrous aluminum chloride over 2 hours in a 2 liter flask equipped as before. After the addition of the benzene-product mixture to the benzene-AlCl<sub>3</sub> mixture is complete, heating and stirring as described above is to be continued for another hour. Cool and pour into 1 kilo of crushed ice that has been mixed with 100 ml of coned hydrochloric acid. The benzene layer is separated and the aqueous layer is extracted with ether. These two layers are combined, washed with water, with saturated sodium bicarbonate solution, and again with water. Dry the solution over sodium sulfate and remove the benzene-ether by distilling in vacuo. The remaining dark residue is distilled in a flask that allows the side arm to be heated also. Your thermometer should be placed in the side arm to get an accurate reading and 1-2 mm of vacuum should be used to keep the product from decomposing. The product will pass over the condenser at 122-125° at 1-2 mm vacuum. Yield: 130-139 g, mp: 68-70°.

The diphenylacetoneitrile is purified by dissolving in hot isopropyl alcohol (1 ml per g of product) and cool slowly. After complete crystallization, filter and wash with cold isopropyl alcohol (0.2 ml per g). Yield: 97-100 g, mp: 74-75°.

*l-Dimethylamino-2-chloropropane.* This chloramine is prepared by treating *l*-dimethyl-2-propanol with thionyl chloride as instructed on the report to the Office of the Publication Board, Department of Commerce, Report No. PB-981, page 96-A. If your library (like mine) does not have a copy, you may get one by calling or writing the Department of Commerce. You may also make the chloramine by chlorinating dimethylamino-propane in the formula for the DOM analog IF (4-chloro-2,5-dimethoxyamphetamine or many similar formulas for chloro amphetamines).

*Condensation of Diphenylacetoneitrile with l-Dimethylamino-2-chloropropane.* In a 500 ml, 3 necked flask equipped with a reflux condenser, a gas inlet tube, and a stirring device is placed 15 ml of dry xylene and 154 ml of dried *t*-butyl alcohol. 8.6 g of potassium are added in small portions over a 90 min period while passing a slow stream of nitrogen through the flask. The reaction mixture is then refluxed until all of the potassium is dissolved (about 3 hours). Remove the heat and add 42.6 g of diphenylacetoneitrile in one portion with stirring. The resulting deep red solution is boiled gently and with stirring, 30.5 g of *l*-dimethylamino-2-chloropropane are added through a dropping funnel (that replaced the gas inlet tube). Make the addition over a 30

min period and continue heating for 2½ hours more. Separate the potassium chloride from the now yellow mixture and remove the alcohol by distillation. Add enough water to dissolve the inorganic material and extract the mixture with ether. The ether layer is extracted with dilute HCl acid, and the addition of 20% NaOH to the acid layer liberated an oil that is taken up in ether. Dry the ether solution with anhydrous sodium sulfate and evaporate the ether to get a mixture of two nitriles. Yield: 57 g.

To separate the nitriles in the above semi-solid form; chill on an ice bath and triturate with hexane. The high melting nitrile is insoluble in the cold hexane and can be filtered off. The low melting nitrile that is dissolved in the filtrate is evaporated to dryness on a steam bath. The resulting oily residue is distilled in vacuo at 162-165° at 1-2 mm. This low melting nitrile will not give Amidone when treated with the Grignard reagent and is, therefore, not used further. To understand more of this operation see JACS 69, 2455.

*Amidone.* The Grignard reagent is prepared like this; a solution of n-ethyl bromide (.5 mole) is added to 12.2 g Mg in 100 ml of ether (preferably dry ether). 0.075 mole of this reagent is reacted with 10 g of the high melting nitrile by refluxing them together with ether for two days. Or to a flask, with a dropping funnel and reflux condenser, add 0.58 g Mg filings (see reduction section to clean first) and 10 ml of dry ether. Add a few drops of ethyl bromide (mixed with 15 ml of ether) and begin the reaction by adding 2 drops methyl iodide. Add the remaining ethyl bromide over 15 min with stirring, and gentle refluxing. Reflux for 3 hours after addition and cool. Cool in ice bath and add 3 g of the high melting nitrile (mixed in 5 ml ether) dropwise with stirring over 45 min. Reflux for 4 hours and pour into a solution of 20 ml coned HCl acid in 50 ml of H<sub>2</sub>O after a good cooling down from reflux temp. The organic layer is discarded and the aqueous layer is made basic with NaOH solution. This basic mixture is extracted with ether, dried, and evaporated. The pale yellow residue is dried in a vacuum desiccator containing solid KOH and coned sulfuric acid. Dissolve in ether and pass hydrogen chloride gas through the solution. Digest with acetone and recrystallize from isopropyl alcohol (digest does not refer to eating or consuming bodily) to get Amidone.

*Isoamidone.* This drug is prepared by reacting the low melting nitrile with the Grignard reagent as above on the high melting nitrile. According to the literature cited (JACS, 69, 2454) this low melting nitrile is much more resistant to hydrolysis from the Grignard reagent and may need to be subject to more vigorous hydrolysis conditions. Isoamidone is slightly less potent than methadone, so it would be worth the trouble to change into an active compound. A variety of related compounds have been obtained by analogous procedures to the one above by substitution of many parts of the molecule during synthesis. For a detailed report on structure activity relationships see *Medicinal Chemistry, A Series of Monographs*, Vol. 5, 179 (1965) Analgetics. This book also has references for the synthesis of most any analgetic ever developed.

### **N-Methylmorphinane.** JACS, 75, 2096

5-hydroxyisoquinoline can be made several ways. I have chosen what is claimed to be the easiest route, however, you may see JCS, 1475 (1935) combined with JACS, 75, 2096 to use another type of synthesis.

*Isoquinoline-5-Sulfonic Acid.* Add 221 g reagent grade isoquinoline to 183 g of coned sulfuric acid. The resulting product is broken into small lumps and added to 561 g of 65% fuming sulfuric acid, with swirling, in a dry ice chloroform bath to keep the temp below 40°. After complete

addition, let solution stand for 24 hours at room temp and then pour onto 1930 g of ice. The product separates as white needles and is filtered off to give a little over 200 g.

*5-Hydroxyisoquinoline.* A mixture of 210 g of KOH and 210 g of NaOH is heated to 170° and 126 g of the above sulfonic acid is added, while the temp rises to 200°. Maintain the temp at 210-230° for 10 min, causing the color of the mixture to turn from yellow to brown and also a little foaming will occur. Add the mixture to 1,200 ml of water and 440 ml of acetic acid. The crude product (about 80 g) is dissolved in a mixture of 200 ml of water and 58 ml of coned hydrochloric acid, filter, and reprecipitate by adding 58 ml of coned ammonium hydroxide to get 73 g of product. Gently warm 17 g of this product with 22 g of methyl p-toluenesulfonate. This is a very exothermic reaction, but it can be controlled on this small scale. For larger scale reaction add the methyl p-toluenesulfonate gradually to a stirred, refluxing suspension of the above product in methanol. Yield: 30 g, for small scale, of yellow needles.

*l-Benzyl-Methyl-5-Hydroxy-1,2,3,4-Tetrahydroisoquinoline.* 75.9 g of benzyl chloride is added to a suspension of 14.5 g of magnesium turnings (cleaned) in 750 ml of ether over 30 min. The solution is stirred for ten minutes more and then 66 g of dry powdered, product from above, is added over a 20 min period. Continue stirring for another 20 min after the addition, then pour onto kg of ice and water containing 105 ml of coned HCl acid. Insoluble material is removed by filtration, the ether layer is separated and the water layer extracted with ether. Add 105 ml of ammonium hydroxide to liberate the product as a pale yellow oil that darkens on exposure to air. Take this product up in ether and extract the aqueous phase several more times with ether. Combine the ethers together and dry over a drying agent. Filter and evaporate (in vacuo) to get about 25 g of purple syrup, which is immediately hydrogenated in 100 ml of acetic acid by using palladium-on-charcoal catalyst and heating to 50° at 50 psi initial hydrogen pressure. Remove the catalyst in the usual manner and evaporate the solvent to get a red syrup, which is recrystallized from 20 ml of coned ammonium hydroxide in 100 ml of water, to give about 25 g-

*1-Benzyl-2-Methyl-5-Hydroxydecahydroisoquinoline.* A solution of 26.5 g of the above compound in 150 ml of 2 N sodium hydroxide to which Raney nickel has been added (about 5 g of catalyst), is shaken with hydrogen at an initial pressure of 825 psi. The temp is raised until reduction is started (about 175°) and then slowly raised to 20° more. Reduction is usually complete after about 6 hours. Remember that good agitation is required during the entire reduction. The product is separated as a separate phase. It is extracted with benzene and distilled at 0.4 mm of vacuo at 120-143°. Yield: 14.8 g. Not all of this material is soluble in dilute HCl acid, so 6.6 g of the product is taken up in benzene and washed in 8 ml of phosphoric acid in water. Addition of potassium carbonate yielded 3.7 g of oil, which is distilled at 141-146° at 0.3 mm of vacuo.

*N-Methylmorphinane.* 2.7 g of the decahydro compound above in 25 ml of 85% phosphoric acid is refluxed for 70 hours and then poured onto ice. The aqueous phase is extracted with ether and the product is salted out with potassium carbonate. It is then taken up with ether, dried, and distilled at 130-132° at 0.7 mm of vacuo to give 1 g of N-Methyl morphinane mixed with a small amount of octahydroisoquinoline, which can be removed by column chromatography. Use 0.5 g of product in 4 ml of low boiling petroleum ether and add onto the top of 30 g of aluminum oxide in a 50 ml buret or column. Elute with 20 ml portions of low boiling ether to which is added 0,0,0,1,3,5,5, and 5 ml of ethyl ether, respectively. The last three portions eluted over 0.3 g of purified product.

### 3-Hydroxy-N-Methylisomorphinan

This drug is claimed to be 9 times more potent than morphine. The next to the last step is also active, being about 6-7 times as active as morphine.

*6-Methoxy-2-Naphthol.* A mixture of 10 g of 6-bromo-2-methoxynaphthalene, 0.5 g of copper bronze, 8.5 g of NaOH, and 175 cc of water are shaken in a suitable high pressure vessel at 200° for 75 minute. Cool, dilute with a little water, filter copper off, and acidify with coned HCl acid. Collect the resulting product, wash with water and dry in air. Recrystallize the resulting crude product with dilute ethanol to get a little over 5 g.

*6-Methoxy-1-Nitroso-2-Naphthol.* A fine suspension of 8 g of the above naphthol in dilute acetic acid (this can be accomplished by adding 75 g of ice to 38 cc of acetic acid) is treated rapidly with 3.17 g of solid sodium nitrite, with vigorous stirring. The mixture is stirred at -5° for 20 min and an additional .35 g of sodium nitrite is added. Continue stirring for 20 min and the resulting yellow, brown solid is collected, washed well with water, then with methanol and dried. Yield: 8.4 g.

*6-Methoxy-1,2-Naphthoquinone.* 20 g of the above nitronaphthol is hydrogenated over 10% palladium, on carbon, in 1 liter of 24% aqueous acetic acid that has been acidified with sulfuric acid, at room temp and atmospheric pressure. The uptake of hydrogen (which is piped into the reaction vessel) can take from 1 to 4 hours, depending on the quality of the nitrous compound. Filter rapidly into a nitrogen flushed flask. Rinse the reaction flask with dilute acetic acid (24%) and use these rinsings to wash product from the catalyst. The filtrate is immediately oxidized by the addition of a solution of 56 g of ferric chloride hexahydrate in 500 cc of water and 30 cc of HCl acid. The quinone will separate as a light yellow-brown solid, which is collected (by filtration), washed good with water, and after air drying, weighs 16.2 g.

*Ethyl (6-Methoxy-1,2-naphthoquinonyl-6) Cyanoacetate.* The above naphthoquinone (21.7 g) is added to a solution of 500 cc of ethanol and 14 cc of ethyl cyanoacetate, followed by the addition of 32 cc triethylamine. A deep purple color will develop and the mixture should be swirled for 4 min to dissolve the quinone completely. A solution of 75.9 g of potassium ferricyanide in 320 cc of water is then added to the solution, causing a thick dark complex to form and separate. Redissolve by adding a solution of 24 g of sodium carbonate in 1,600 cc of water. Swirl or stir and filter through diatomaceous filter aid. Acidify the filtrate with 100 cc of 6 M sulfuric acid to precipitate 34.8 g of red-orange powder, which is oven dried at 70°. Recrystallize from ethyl acetate to get 19.3 g, mp: 157-158.5°. The remaining filtrate is evaporated to a small bulk and recrystallization from ethyl acetate gives an additional 2.8 g of product.

*6-Methoxy-4-Cyanomethyl-1,2-Naphthoquinone.* 10 g of the above acetate in 50 cc of alcohol is treated with 50 cc of 10% NaOH and 50 cc of water. Swirl or stir the solution for 25 minute to see the color change from purple to deep red. Filter with diatomaceous filter aid and acidify with 6 N hydrochloric acid. A resulting red-brown solid is collected and air dried to give 7.2 g of product.

*3-Methoxy-9,10-Dioxo-13-Cyanomethyl-5,8,9,10,13,14-Hexahydrophenanthrene.* 1.95 g of the above naphthoquinone is suspended in 45 cc of absolute dioxane and 25 cc of butadiene in a glass lined autoclave and is heated for 47 hours. The cooled reaction is concentrated (by evaporation) and the residue is crystallized from benzene in two crops, to give 1.45 g of product, which is recrystallized twice from methanol.

*3-Methoxy-delta-6-Dehydro-10,16-Dioxoisomorphinan.* One g of the above phenanthrene and 200 mg of copper chromite are suspended in 30 cc of absolute alcohol and reduced in an autoclave at 144-150° with 25 atmospheres hydrogen pressure (cold, before heating, that's where pressure was set) for 4 hours. The cooled reaction mixture is decolorized with Norit, filtered, and concentrated. Pale, yellow prismatic needles (585 mg) are separated. This step can be accomplished in larger scale at the expense of the yield.

*3-Methoxy-delta-6-Dehydro-16-Oxoisomorphinan.* A solution of the above dioxoisomorphinan (2.88 g) and 9 g of potassium hydroxide in 15 cc of 100% hydrazine hydrate and 35 cc of diethylene glycol, is heated to 150-155° for 1 hour. The yellow azine separated on addition of the ketone, which dissolved in about 5 min. The cooled reaction mixture is cooled diluted with water, the precipitate collected, and washed with water to give 2.49 g of fine white needles of product.

*Racemic 3-Methoxy-delta-6-Dehydro-N-Methylisomorphinan.* One g of the above oxoisomorphinan in 175 cc of toluene is concentrated to a volume of 125 cc by boiling gently. To this solution is added 96 mg of sodium hydride, and the mixture is heated under reflux (taking precautions against H<sub>2</sub>O entering the reaction) for 1 hour. Cool, add 5.3 g of methyl iodide and reflux for 2 hours. Concentrate with gentle heating to about 20 cc, cool, take into 100 cc of dry ether, treat with 5 cc of a 1 M ethereal solution of LAH, and heat at reflux for 48 hours. Excess hydride is destroyed by the addition of ethyl acetate followed by 30 cc of 2 N hydrochloric acid. The acid layer is separated, and the organic layer is extracted, 3 times, with small portions of 6 N HCl acid. The combined acid extracts are added slowly to an excess solution KOH and potassium sodium tartrate. The free base, which separates as a yellow-brown oil, is extracted from the alkaline mixture with 6 small portions of peroxide-free ether. The extracts are washed, dried over sodium sulfate, and taken to dryness, to yield 950 mg of a yellow viscous oil.

*3-Hydroxy-delta-6-Dehydro-N-Methylisomorphinan.* This drug is active and considerably more potent than morphine. Therefore, you may stop after completion of this step, or you can make an even more potent drug by completing the last step. 200 mg of the product immediately above is heated for three hours under nitrogen at 225°, with a solution of 7 pellets KOH, 4 drops hydrazine hydrate and 6 cc of diethylene glycol. (The mixture is blown gently with nitrogen for the first 7 minutes.) The cooled yellow mixture is diluted with water, containing a small amount of sodium hydrosulfite, and carbonated to excess. The resulting solid is taken into 6 chloroform extracts and the extracts are combined, washed with water, dried over sodium sulfate, coned, and crystallized by moistening with ethyl acetate. Recrystallize twice from ethyl acetate to get 53 mg of colorless needles.

*Note:* To get better yields, the product, 3-methoxy-delta-6-dehydro-N-methylisomorphinan is first converted to its picrate state by treating the total yield in boiling alcohol with a hot solution of 920 mg of picric acid in alcohol and collecting. To use it in the step immediately above, it must be regenerated, by heating under nitrogen for 3 hours with chloroform and dilute aluminum hydroxide. For the proper amount to fit perfectly into the step above, regenerate 205 mg of the picrate. Some sources say it is a must to convert to picrate and regenerate.

*3-Hydroxy-N-Methylisomorphinan.* 24 mg of the 3-hydroxy-delta-6-dehydro-N-methylmorphinan is hydrogenated over 5 mg of Adams catalyst in 15 cc of alcohol. H<sub>2</sub> uptake is complete after 35 min. The solution is filtered, concentrated, and the residue is crystallized from benzene to yield 24 mg of colorless fine prisms.

*Note:* This series of steps is rather difficult, but once a competent chemist has his laboratory set up properly, it is not as hard as it looks. The small scale at which these steps are designed is overcome by the potency of the drug. Some sources say the racemic versions are not as potent as the 1-forms. You can make either, by obtaining the reference that gave me this formula above; JACS, 80, 1186(1958).

### **Methyldihydromorphinone.** JACS, 58, 1459 (1936)

This drug is over three times more powerful than morphine. Although, not as addictive as morphine, it is still addictive and should be used irregularly, with a great deal of care. The starting material is the useless alkaloid thebaine, which can be purchased from most any chemical supply company. The first two steps can be eliminated by purchasing this particular substance directly from chemical suppliers.

*Dihydrothebaine.* To a solution of 75 g of thebaine in 150 cc of 3 N acetic acid is added 4 cc of coned HCl acid, 4 cc of 1% palladous chloride solution and 0.1 g of gum arabic. The solution is then hydrogenated at an initial of 46 psi (3.1 atmospheres) in 12 to 24 hours, depending on the speed at which the 1.7 moles of hydrogen is taken up. Reduction is much faster and smoother if the process is made continuous. This is accomplished by putting the next 75 g batch of thebaine in immediately without removing the residue of used catalyst (leave just the residue). The majority of the catalyst is removed by filtration through Norit, and the solution is treated slowly, with an excess of NaOH in the presence of a few cc of ether. 30 to 40 g of dihydrothebaine separated out in crystalline form is dissolved, filtered hot, and brought back to crystals by cooling. Yield: 25 g, mp: 161-163°.

*Methyldihydrothebainone.* 40 grams of dihydrothebainone in a Soxhlet extractor (see the equipment chapter), rigged to a 2 or 3 necked flask that is equipped with a mercury-sealed stirring device, is extracted into 600 cc of molar methylmagnesium iodide (the Grignard reagent, see reductions chapter for more information) for 36 hours. Stirring and heating are continued for another 73 hours, increasing a white precipitate notably. The amorphous magnesium complex is decomposed by dissolving in 800 cc of 3 N hydrochloric acid and the entire solution is then extracted with several portions of ether (totaling 1.5 liters of ether), which should remove a little oily material. The aqueous layer is made alkaline with ammonia, then extracted with enough small portions of ether to total 8 liters. During this ether extraction you will notice some slight red coloration, indicating the beginning of oxidation, which is very undesirable. To prevent this oxidation add a little bit of sodium hydrosulfite the instant a red or pink color is noticeable. Add picric acid to the aqueous layer to precipitate 25 g of amorphous picrate. From this picrate 1.6 g of methyldihydrothebainone can be recovered. The ether extracts yielded about 20 g of oily crystals, which are recrystallized from absolute ethanol to give about 7 g of methyldihydrothebainone in the pure state. The ethanol mother liquors are combined, concentrated by evaporation, and treated with alcoholic hydrogen chloride to give 6 g of the hydrochloride, from which 5 g of impure methyldihydrothebainone can be recovered and purified by recrystallization from absolute ethanol. Brominate as follows.

A solution of methyldihydrothebainone (20 g) in 200 cc of glacial acetic acid is stirred and treated dropwise with 193 cc of a solution, which is prepared by adding 32 g of bromine to 300 cc of glacial acetic acid. The treatment, which is really just an addition, is carried out over 3 hours. The resulting clear yellow solution is concentrated to a viscous mass at 70° under low (water pump) vacuo. The oil is treated with excess 10 N NaOH solution, and the precipitated base is



extracted into ether. The ether is washed with four 100 cc portions of normal NaOH to yield 18 g of oily crystals, which are purified with ethyl acetate to give pure bromomethyldihydrocodeinone, mp: 143-145°.

*Methyldihydrocodeinone.* A solution of bromomethyldihydrocodeinone (18.2 g) in 200 cc of 2 N acetic acid with 5 g of potassium acetate, a small amount of gum arabic, and 10 cc of 1% palladium chloride solution, was hydrogenated (see reductions chapter for instructions to hydrogenate). Remove the catalyst by filtration, make alkaline with NaOH, and extract with small portions of ether until a total of 2 liters is used. Combine the ether extracts, wash thoroughly with dilute alkali, and filter off the 12 g of white crystalline product. Recrystallize with ether or ethyl acetate to get mp of 144-144.5°.

*Methyldihydromorphinone.* A solution of 2 g of methyldihydrocodeinone in 10 cc of 48% hydrobromic acid is boiled for 25 min. The solution is then diluted with water, made strongly alkaline, and extracted with ether. Add ammonium chloride to precipitate the phenolic product, 1.7 g of brown powder. Sublime (see glossary for instructions) in a high vacuum at 180° to get 1.4 g of white crystals of methyldihydromorphinone. Recrystallize from alcohol to get pure, long needles, mp 243-245°. The hydrochloride form is prepared, as usual, in dry ethanol and recrystallized from the same. This drug is sometimes called Metopon and is active orally.

### **Dromoran** (Sometimes called Methorphan or 3-Hydroxy-N-Methyl-Morphinan)

This drug is quite easily synthesized, yet it contains the same numbering system as morphine, which is considerably harder to synthesize. Although Dromoran lacks the oxygen bridge, the Alicyclic double bond, and the alcoholic hydroxyl of morphine it is still 4-5 times more powerful, as well as longer acting. The average dose is 1 to 3 mg intramuscularly injected. Dromoran has less than one half the addiction liability of morphine and is, therefore, used almost exclusively for severe injuries, amputations, etc. The incredible feeling of well being it produces, is accompanied with addiction, so it cannot be used regularly. It also has no marked hypnotic effect, so it may be taken and enjoyed without drowsiness or reduced clarity of thought. The drug is well tolerated and does not depress blood pressure or cause other circulatory disturbances. The effects begin after 10 minutes and continue for 9 to 13 hours with a minimal dose.

This first formula is a street method, but I am sure it was taken from the Swiss patents 252,755 and/or 254,106. You should always look up all references, even though I know that this method does work and I have double checked all the figures.

Prepare a Grignard reagent from 325 parts (as usual all parts refer to parts by weight) of p-methoxy-benzyl bromide in 800 parts of absolute ether with 40 parts thin clean magnesium (unlike THC's, different Grignard reagents cannot be substituted here) and cool to 0°-3°. 275 parts of (5,6,7,8) tetrahydroisoquinoline methiodide are added in small portions. This mixture is allowed to stand for 1 hour at 0° C and saturate with ammonium chloride after pouring onto cracked ice, then basify with ammonia by adding in small portions and checking pH often. Separate the ether solution and extract the base with hydrochloric acid. The acid solution is basified with ammonia and extracted with ether, the ethereal solution is dried in the usual manner. Remove the ether by evaporation in vacuo with gentle heating, or distill it out at a low temp in the next step. Distill with 0.2 mm of vacuo, collecting the fraction at 149° to 154° to get the desired base.

The above base is catalytically hydrogenated (platinum oxide seems to work the best) to 1-(p-methoxybenzyl)-2-methyl-1,2,3,4,5,6,7,8-octahydro-isoquinoline. This is separated from the

catalyst and purified by distilling under 0.2 mm of vacuum, collecting the fraction at 138-142°. Heat at 150° for 3 days with ten times its weight of phosphoric acid (specific gravity 1.75). The resulting brown solution is cooled with ice (in water and externally) and made alkaline to the indicator phenolphthalein, by carefully adding ammonia. The free base is then shaken out with ether (this is an extraction) and the ether is removed by evaporation in vacuo. Purify the Dromoran by sublimation on an oil bath, at 180° to 199° with 0.3 mm of vacuo and recrystallize once with anisole, or recrystallize twice with anisole after evaporating the ether. Yield: about 30-35%. To get the hydrochloride form, or the sulphate, etc., use any of the above methods for isomethorphan, amidone, etc.

### **Dromoran** JOC, 24, 2043 (1950)

This method is more modern than the last and it gives details for making a lower starting material, eliminating the need for purchasing (5,6,7,8) tetrahydroisoquinoline methiodide.

6.2 g of 2-(1,4-cyclohexadienyl)ethylamine in 80 ml of benzene is treated with p-methoxyphenylacetyl chloride (9.4 g in benzene) in the presence of sodium bicarbonate (200 ml of a 5% solution) with stirring and external cooling. An oily amide results, which solidifies (crystallizes) upon scratching the flask with a glass rod (see crystallization in the equipment chapter). Recrystallize from a mixture of n-hexane and benzene to get colorless scales that melt at 86-86.5°. Yield of this N-2(1,4-cyclohexadienyl)ethyl-p-methoxyphenylacetamide is 12.5 g or 92%.

A mixture of the above amide (3 g), phosphoryl chloride (3 g) and 50 ml of benzene is refluxed for 30 minute creating a reddish-yellow solution and evolution of hydrogen chloride. Cool, add enough petroleum ether to give a reddish precipitate, which is separated by filtration, after allowing to stand long enough to make sure no more precipitation will occur. Dissolve the precipitate in dilute hydrochloric acid, then shake with benzene and filter through a benzene wetted filter paper. Make the filtrate alkaline by carefully adding a strong caustic soda solution with external cooling and stirring. Separate the benzene layer and dry, evaporate the solvent (benzene) under vacuo in a hydrogen atmosphere. Dissolve the red residue in 50 ml of methanol and reduce over 1.5 g of Raney nickel (see reductions chapter for complete information, then work in 1.5 g of catalyst). The catalyst is removed by filtration and the solvent by evaporation in vacuo. The residue is dissolved in benzene and purified by running through an alumina filled chromatography column. Evaporate the benzene in vacuo and dissolve the resulting yellow, oily base in methanol (50 ml), neutralize with hydrobromic acid, and evaporate in vacuo. The residue crystallizes on scratching with a glass rod. Use a minimum amount of water to dissolve, upon boiling, add decolorizing carbon and filter off hot to get *Vh.* g of the hydrobromide salt of 1-p-methoxybenzyl-1,2,3,4,5,6,7,8-octahydroisoquinoline as colorless prisms, mp: 197-198°.

The above quinoline can be converted in several ways to Dromoran. The process given below methylates it at the same time as the reduction takes place and is a superior operation.

Reduce the quinoline catalytically in the presence of formaldehyde. Most any of the general methods of catalytic reductions found in the reductions chapter will work fine, as long you remember to use formaldehyde.

Another method is to proceed after the Raney Nickel reduction like this: filter the catalyst off and purify as above. React the product with CH<sub>2</sub>O and hydrogen or HCO<sub>2</sub>H to get the 2-Me derivative, which is heated with H<sub>3</sub>PO<sub>4</sub> at 140-150° for 70 hours. *Note:* HCO<sub>2</sub>H is a strange way to say formic acid.

### Dihydromorphinone and Dihydrocodeinone

If you have morphine or codeine, then it is only a matter of one reduction to convert them into these powerful derivatives. Morphine can be obtained (sometimes) in some prescription medicines or by ordering the seeds of opium poppies (which are legal) and growing your own plants. Seeds can be purchased from: Faunas Health, PO Box 12336, Law, KS 66044-8236 or NW, PO Box 962(H), Orlando, FL 32802-0962. The cost is about \$6 for about 5000 seeds. If you do not want to wait for the 3 to 4 months it takes to grow these plants, then you go down to the local drug store and get codeine cough syrup for about \$6 or \$7 a pint. The codeine is removed by distillation with steam or it can be extracted (look in the *Merck Index*). Buy the cough syrup that has Dextromethorphan and Ephedrine in it, as these are psychoactive also. Codeine is made from morphine, so don't bother looking up the synthesis for it.

Dihydromorphinone is 3-4 times more powerful than morphine and dihydrocodeinone is just a little less than morphine in potency. Their pitfall is an addiction liability, as great if not greater than morphine. To produce: Hydrogenate morphine or codeine in a warm, strongly acidic solution, in a large excess of palladium or platinum catalyst, as per instructed in the reductions chapter.

Dihydrothebaine can be converted to dihydromorphinone by hydrolysis, but I could not find the specifics to this operation.

### Nalorphine (N-Allylnormorphine)

This drug has the same potency as morphine, but it is not addictive, as it is a narcotic antagonist. It is used successfully as an antidote for narcotic overdose and for the relief of severe pain. At doses of over 10 mg it is hallucinogenic (much like MDA) and can cause restlessness, excitability and hallucinations.

35 g of normorphine (see Ber, 63, 852 (1930) or (Ber, 47, 2312 (1914)) and 7.95 g of allyl bromide in 350 cc of chloroform are heated in a sealed tube (a bomb, as in the reductions chapter will work super) at 110° for 3<sup>1</sup>/<sub>i</sub> hours. The reaction mixture is filtered and the solid residue is washed with chloroform. The unreacted normorphine is separated from the product (normorphine hydrobromide) by dissolving in water and precipitating the base with ammonia water at a pH of 8. The yield of unreacted normorphine is 18 g. The filtrate from above was evaporated in vacuo to remove the chloroform and the resulting residue is triturated with 75 cc of ether. Cool on an ice bath for 2 hours and filter to get 9.2 g of crude nalorphine. Extract for 15 hours in a Soxhlet extractor with dry ether. Concentrate the ether extract in absence of air and cool in freezer for 12 hours. The white crystals are collected by filtration and washed with some cold ether, then dried in vacuo to yield 5% g of pure product, mp: 208-209°. The hydrobromide form is obtained by dissolving the above free base in ethanol and a slight excess of hydrobromic acid is added. The hydrobromide will crystallize out quickly by scratching the sides of the flask with a glass rod. The crystals are filtered off, washed with cold alcohol and dried in vacuo. Mp: 258-259°.

# HYPNOTICS, SEDATIVES, AND TRANQUILIZERS

The substances to be described in this chapter are those synthetic, organic compounds, which depress the central nervous system. A drug can be classed as a hypnotic, if a normal dose has the power to induce sleep. Sedatives or tranquilizers are drugs that do not induce sleep, but calm the nerves and bring about a relief of tension, hysteria or apprehension when used in normal doses. Such definitions are not rigid, since hypnotics in small doses may induce sedation and not sleep, and conversely sedatives in large doses may induce sleep. Some hypnotics can also be classified as anesthetics because of the deep unconsciousness that they produce. As with any drug in this book, a great deal of caution should be used when using these central nervous system depressants. Call a pharmacist or read a nursing handbook and find the restrictions before you even attempt to make the drug. A few rules to be used with all depressants are:

1. Never mix these drugs with any others, especially alcohol.
2. Never drive or operate any machinery after administration.
3. Never administer regularly, as these drugs are usually addictive and toxic. Some cause liver damage with regular use.
4. Be very careful when measuring out a dose, as some of these drugs are very powerful and can easily create an overdose situation.
5. Take a very small dose to begin with, to see if an allergic reaction may result in your metabolism.

## *DERIVATIVES OF BARBITURIC ACID*

By far, the biggest class of hypnotic drugs are derivatives of barbituric acid. The action of barbiturates is reliable and reproducible, they are easy to administer and offer a wide range of activity.

## *CLASSIFICATION OF BARBITURATES*

It would be extremely tedious for you to read the synthesis of all the barbituric acid derivatives that exist today, so I will limit you to the more widely used and important ones. I have grouped the listed barbiturates by their clinical action and the duration of that action.

### Long Acting Barbiturates

These need to be given one hour before the effect is desired and their effect is so prolonged that you will remain drowsy the following day.

*Barbitone.* This is also called barbital or veronol. I will start this synthesis with the intermediates (precursors) of the given formulas. Some of these formulas are given on a commercial basis and can be reduced to the size of your budget.

*Sodium Malonate.* 100 kilos of Chloroacetic acid are dissolved in the minimum amount of cold water (this may vary, but it is usually about 20 liters). This mixture is stirred slowly during the addition of a solution consisting of 120 kilos of anhydrous sodium carbonate in 350 liters of water, keeping the temp at 0°. An excess of alkali is avoided throughout this entire step. 60 kilos of sodium cyanide is dissolved in 100 liters of water and heated to 70°, then the above solution is added, rather slowly, with good stirring. The heat involved must be controlled internally as well as externally on the larger scale of production to keep the temp below 90°. This can be accomplished by floating sealed packages of ice in the mixture or by using internal cooling coils filled with ice cold, running liquids. Air in and around the reaction kettle needs to be evacuated and well ventilated. The reaction is complete after about 20 min and the mixture is raised to a boil and a solution of 80 kilos of sodium hydroxide in 160 liters of water is added. This solution is boiled until the evolution of ammonia stops (about 3 hours for this size formula), you will no longer be able to smell ammonia. The solution is then evaporated and the residue is powdered. Yield: 220 kilos of powder, 155 kilos of which is sodium malonate and the rest is sodium chloride. (If you do not have the resources to make a huge batch, as the one just described, take the amounts given and divide by 1,000. 100 kilos is turned into 100 g. The reaction times may change slightly, but all temps given will remain the same.)

*Diethyl Malonate.* 200 kilos of the above powder (sodium malonate can be purchased cheaply without alarming DEA officials. I gave the above formula for do-it-yourselfers) is stirred with 160 kilos of ethanol (industrial spirit) and 500 kilos of benzene in an esterification kettle. About 240 kilos of coned sulfuric acid are added, at such a rate that the temp of this well stirred mixture never exceeds 25° (this will take several hours for a formula this big). The temp is then raised to 60° and maintained for at least 8 hours and then cooled. The top benzene layer is removed and the lower acid layer is extracted with benzene repeatedly. The combined benzene layers are washed free of acid, with dilute sodium hydroxide, and dried over anhydrous sodium carbonate and then distilled under vacuo (20 mm). The fraction boiling at 96-98° is collected as commercially pure diethyl malonate. Yield: 85-90% of theoretical.

*Diethyl Malonic Ester (diethyl diethyl malonate).* (Great care must be taken to keep H<sub>2</sub>O from this reaction, even the moisture in the air can hurt the yield.) A sodium ethylate solution is made by dissolving 13.2 kilos of clean sodium metal in 200 liters of absolute ethanol and heated to 60°, then maintained at this temp during the addition of the above diethyl malonate (84 kilos). Now, raise the temp to 80° and add 65 kilos of ethyl bromide over 3 hours. After the addition, reflux for 2 hours then distill until the temp reaches 110°. At this point, a further solution of sodium ethylate (again consisting of 13.2 kilos of sodium and 200 liters of dry ethanol) is heated to 60° and added to the distillation residue. The mixture is stirred and heated until homogenous, then a further 65 kilos of ethyl bromide is added over 3 hours and the temp maintained at 60°. Reflux is again applied for 2 more hours, then distilled until the liquid temp reaches 110°. After cooling slightly the residue is treated with the addition of 150 liters of water, agitated briskly and

allowed to separate into two layers. The upper layer is crude diethyl malonic ester and it is separated and dried over anhydrous sulphate, then distilled in vacuo. Collect the pure ester coming over at 132-135° at 28 mm of vacuo. Yield: 80-85% (88 to 94 kilos).

*Barbitone.* (Barbital, veronal, 5:5-diethyl malonyl urea) The exclusion of water is also paramount in this step (use drying tubes, etc.). 30 kilos of dry urea and 76.5 kilos of the above malonate (dry diethyl diethyl malonate) are placed in the reaction vessel and stirred very well. To this mixture is added a solution of hot (75°) sodium ethylate (18 kilos of clean sodium metal in 270 liters of dry ethanol) and the mixture is brought to a boil with good stirring. The alcohol is removed with the boiling action (the reaction vessel is equipped with a slanted vapor condenser) and the mixture becomes more viscous. The alcohol (ethanol) is distilled out completely and the heat is then removed. The residue left behind should be a creamy white powder.

The free acid — 5:5 diethyl malonyl urea or diethyl barbituric acid is prepared as follows. 85 kilos of coned hydrochloric acid is diluted with 100 liters of water and cooled by adding 300 kilos of crushed ice. The above dry powder is added to this mixture, gradually, with good stirring, so that the mixture is always acidic to congo red. Cool to keep the temp down below 0°. Stir for several hours, centrifuge or filter with vacuo, wash with 20 to 30 liters of water, centrifuge, wash again, and centrifuge. The crude acid resulting is dissolved in 800 liters of water at boiling temp, is treated with  $\frac{1}{2}$  kilo of decolorizing charcoal, and boiled for another minute. The boiling mixture is filtered, as hot as possible, through a heated funnel with a suitable gravity filter. The crystals precipitate from the filtrate, which is cooled externally and stirred slowly (cold running water is good for the cooling). The precipitate is centrifuged or filtered and washed with 20 liters of cold water and dried in vacuo at 50°. Yield of pure diethyl barbituric acid (barbitone) is about 50 kilos, 90%.

*Another Method for 5:5-Diethyl Barbituric Acid.* (This is a scaled down version.) 16 g of clean sodium is dissolved in 300 g of absolute ethanol. To this cooled solution is added 20 g of dry urea and 50 g of diethyl malonic ester (diethyl diethyl malonate). The mixture is heated in an autoclave (pressure cooker, very strong) for 4 to 5 hours at 100-110°. After removing from the autoclave, the mixture is cooled. Upon cooling, the sodium salt of diethyl barbituric acid separates, is filtered off, dissolved in water, and the free acid precipitated by the addition of hydrochloric acid. The acid is filtered and recrystallized from water, using decolorizing carbon, if necessary. Yield: Depends on your ability to exclude H<sub>2</sub>O from the beginning of reaction.

### **Phenobarbitone** (Sometimes called luminal)

Diethyl phenyl ethyl malonate. 1 mole of benzyl cyanide is added dropwise to a solution of 1 mole of ethyl carbonate in 2 liters of anhydrous ethanol containing 5 g of clean sodium metal. This mixture is refluxed (preferably on a steam bath) for 5 hours. It is then cooled and to it is added a cooled mixture of 40 g of sulfuric acid in 100 ml of anhydrous ethanol. This alcoholic solution is refluxed for 5 hours, cooled, neutralized with sodium ethylate (use external indicator). The mixture is evaporated to half bulk, filtered from the sodium sulphate and to it is added 1 mole of clean metallic sodium. Reflux while adding 1 mole of ethyl bromide dropwise. Heat for another 2 hours after the addition is completed. Remove the alcohol by distillation and dissolve the remaining residue in water. Extract the substance from the water with benzene and after drying, the benzene is recovered and the ester should be purified by distilling in vacuo.

*Phenobarbitone.* One mole of the above malonate (or any other suitable malonate analog) and 1.2 moles of dry urea are stirred together in a vessel equipped with drying tubes at all possible

air inlets, a distillation condenser, and an efficient stirring device. To the above mixture add a solution of 1.2 moles of clean metallic sodium in 400 ml of dry ethanol. Heat to boiling and distill the ethanol off slowly, over six hours with stirring. When the alcohol is completely distilled out of the mixture, the remaining white powder is added to a stirred mush of about 126 ml of coned hydrochloric acid and 148 ml of water (or an equimolar amount of ice) and 445 g of finely crushed ice. The mixture is kept at 0° until the acid has crystallized, then it is filtered (or centrifuged) and recrystallized from boiling water, using decolorizing charcoal if necessary. Yield: 65% of theoretical, mp: 178°. It is a white, odorless, crystalline substance with bitter taste. Dosage is normally <sup>1</sup>/<sub>h</sub>. to 2 grains (30 to 120 mg).

Phenobarbitone is used to treat epilepsy, migraine headache, dental infections, pregnancy vomiting, tetanus, enuresis, chorea, pre and post operative sedation, hypertension, anxiety states, neurosis, and in the treatment of drug and alcohol addiction. This drug is also called phenobarbital.

*Methylphenobarbitone.* 1 mole of phenobarbitone (232.23 g) is dissolved in 2.5 liters of 95% (not dry) ethanol. To this is added a solution of 45 g NaOH (sodium hydroxide) in 500 ml of 95% ethanol. This mixture is heated, with stirring, until reflux is achieved. 70 g of dimethyl sulphate is added dropwise and refluxing is continued for 3 hours after this addition. Change the reflux condenser into a distillation condenser and distill the ethanol from the mixture. Add water and pour into an ice-hydrochloric acid mixture at 0°. Recrystallize the resulting precipitation, after collection by filtration, from boiling water using decolorizing charcoal. Yield: 70% of theoretical, mp: 178-181°.

Methylphenobarbitone has the advantage of being 30% less toxic than phenobarbitone and does not have such a strong hypnotic effect. It is well tolerated over long periods, tasteless, and seldom causes skin rash and other unpleasant side effects. The average dose is from 30 to 400 mg (% to 6 grains).

### Moderate Acting Barbiturates

*Allobarbitone.* (Also called Dial.) This is prepared by using the method given for Barbitone. The only difference in the formula is the intermediates involved. Given below is the intermediate for Allobarbitone, use it in place of the intermediate used in the Barbitone formula, and carry out the formula as stated.

Preparation of the intermediate for Allobarbitone (diethyl diallyl malonate). Diethyl malonate is dissolved in anhydrous alcohol and treated with one mole of clean sodium metal per every one mole of the ester. To this solution add one mole of allyl chloride and reflux for about 4<sup>h</sup> hours. Another equimolar ratio (1 mole of sodium per mole of ester) of sodium is added, followed by the same ratio of allyl chloride (1 mole per 1 mole), and this mixture is boiled for 2 hours. The alcohol is removed by distillation and the ester is extracted with benzene and distilled or evaporated in vacuo, recrystallized with a suitable "dry" solvent, and filtered. Evaporate again to remove traces of solvent. Keep this product, and any other substances that require dry reagents or solvents, stored away from contact with the atmosphere. When evaporating, filter the air coming into the evaporating vessel with a suitable drying agent. Use a little common sense.

After the above intermediate is used in the formula for Barbitone, production of Allobarbitone is achieved. Yield: about the same as for Barbitone, mp: 174°. Dosage: % to 3 grains.

*Pentobarbitone.* (Called Nembutal or Pentobarbital.) 26.7 g of clean metallic sodium are dissolved in 400 g of anhydrous (dry) ethanol. To this, a solution of 100 g of 1-methyl butyl-

ethyl malonic ester and 37.2 g of dry urea is added. The mixture is heated for 4 to 6 hours in an autoclave, or refluxed for 20 to 40 hours. The alcohol is then removed by distillation. The residue is dissolved in water and this aqueous solution is acidified with hydrochloric acid. The precipitated product is filtered, washed with cold water, and recrystallized from boiling water. Yield: depends on your ability to exclude H<sub>2</sub>O from the beginning of the reaction, mp: 127-130°.

*Cyclobarbitone.* (Sometimes called Phanodorm.)

*Cyanacetic ester.* Ethyl chloroacetate is dissolved in ethanol and boiled under reflux, with an alcoholic solution of potassium cyanide. The mixture is then filtered hot from resulting potassium chloride and the alcohol is distilled from the filtrate. The resulting residual ester is purified by crystallization or distillation. Bp: 207°

*Ethyl-cyanacetic ester.* 772 parts of the above ester is added and dissolved in a solution of 92 parts sodium in 1,500 parts of dry ethanol. 750 parts of ethyl iodide are gradually added to the mixture, while it boils gently under reflux. Filter the sodium iodide that forms from the solution and distill off the alcohol. After adding water to the residue the ester separates and is purified by vacuum distillation. Collect the fraction around 125° at 4 mm.

*Cyclobarbitone.* Use the intermediate directly above in the formula for Barbitone. This drug is less toxic than most barbiturates and side effects are seldom encountered. It is quite powerful as far as barbiturates go. Dosage is 100 to 200 mg ( $\sqrt{i}$  to 3 grains), 400 mg maximum, mp: 173-176°.

*Hexobarbitone.* (Cyclonal, Evipan.)

*Delta-cydohexenyl-methyl-cyanacetic ester.* 1 mole of clean sodium metal is dissolved in 1,500 ml dry ethanol. 1 mole of delta-cyclohexene bromide is added gradually to the solution, which is then refluxed for 3 hours. Filter to remove the unwanted byproduct, sodium bromide. Distill the alcohol off and add water to the residue to separate the ester. Distill under reduced pressure, or dry with drying agent to remove water. 1 mole of this dried ester is added to 1 mole of sodium in 1,500 ml of dry ethanol, as before, and 1 mole of methyl iodide is added gradually. After the addition, reflux for 3 hours and filter the resulting sodium from the solution. Distill the alcohol from the solution and add water to make the ester separable. After separation distill in vacuo to purify. (See how to tell which fraction coming over is the product by reading the distillation section of the equipment chapter.)

*Hexobarbitone.* (If you have not purified the above ester properly, this final step will most likely fail. This goes for most any formula in this book. If any of the steps listed in any formula could be bypassed they would not be written down.)

12.5 parts (parts by weight not volume, in this and most other formulas) clean sodium metal is dissolved in 300 parts dry ethanol. 40 parts of mono methyl urea and 50 parts of delta-cyclohexenyl-methyl cyanacetic ester are added to the alcohol solution. Reflux for 6 to 8 hours, remove the alcohol by distillation in vacuo, and boil the residue (reflux) with ten times its weight of 20% sulfuric acid. Hexobarbitone crystallizes on cooling and is recrystallized from ethyl acetate.

Hexobarbitone produces deep sleep, its action is rapid, but transitory. Dosage is 15 to 30 mg 0/4 to  $\frac{1}{h}$ . grain) for sleep, more than this may lead to respiratory collapse and death.

*Thiopentone.* (Pentothal, IntraVal.) 34 g of clean metallic sodium are dissolved in 1 liter of dry ethanol. To this solution add 130 g of ethyl-1-methyl butyl malonic ester. This mixture is stirred, 60 g of powdered thiourea is added and the whole is refluxed for 10 hours. Remove the alcohol by distilling under reduced pressure, dissolve the residue with water and acidify with hydrochloric



acid. The precipitate is filtered, washed with cold water and dissolved in a minimum amount of 5% aqueous ammonia solution. A rapid current of carbon dioxide is passed through the solution and the resulting Thiopentone is filtered from the solution, washed with cold water, recrystallized from 95% ethanol using decolorizing charcoal, if necessary. Mp: 158-159° Dosage: 100 to 150 mg.

## **UREIDES**

These are made from urea much like the barbiturates. The formula for urea (given below) can be used to make any of the drugs requiring it for their synthesis. However, it must be dried for those formulas requiring dry or anhydrous urea. This can be accomplished by distillation and shaking with a drying agent. It can also be purchased, but the DBA will be notified.

*Urea.* (Carbamide.) 50 g of potassium cyanide are heated in a large iron crucible over a large burner until it begins to fuse. 140 g of red lead are added, in small portions, while the mixture is stirred with a rod. When the addition is completed and the frothing has ceased, the fused mass is poured onto an iron tray. After cooling, the mass is separated from metallic lead, ground into powder, and digested with 200 cc of cold water for an hour. The mixture is then filtered and the filtrate is treated with 25 g of ammonium sulphate. Evaporate to dryness on a water bath and powder the residue. Transfer the finely powdered residue to a flask, reflux with a moderate amount of ethanol to dissolve the urea from the potassium sulphate, and extract the urea into the ethanol. Decant the ethanol off, add another portion to the residue, reflux again to extract more urea, and decant again. Add one last ethanol portion, reflux, and filter hot. The three combined extracts are evaporated to a small bulk, until crystals of urea separate on cooling and standing. Filter, mp: 132°.

*Carbromal* (Uradal, Adalin.) 1 mole of  $\alpha$ -bromo- $\alpha$ -ethyl butyryl bromide is mixed with dry urea (1 mole) and heated on a steam bath for several hours. Precautions must be taken to keep steam and atmospheric H<sub>2</sub>O from the reaction vessel. Cool, allow to solidify, wash with H<sub>2</sub>O, and recrystallize from alcohol. Dose: (sedative) 300 to 500 mg, (hypnotic) 700 to 950 mg, mp 116-118°. This drug is less potent than the barbiturates, but it is less toxic, extremely well tolerated, has a wide margin of safety, and acts rapidly.

*Bromural* (Bromovaletone) This drug is made the same way that Carbromal is made, except that the intermediate is bromo-isovaleryl bromide. The 1 to 1 molar ratio and everything else remains unchanged. Yields colorless crystals, mp: 147-149°. This is a rapid-action, short-duration hypnotic. It is well tolerated and has a low toxicity. Dosage: 300-600 mg.

### **An Ethane Derivative**

*Paraldehyde.* (Paracetaldehyde.) A paste consisting of 20 cc of water, 10 g mercuric sulphate, and 40 g of ammonium hydrogen sulphate is added to a 1,500 cc glass bottle of strong construction. The bottle is filled three-fourths full with glass beads and shaken thoroughly, fitted with a one holed stopper, carrying a delivery tube that extends past the glass beads to the bottom of the bottle. A current of acetylene (this can be purchased from a welding supplier or made as follows) is developed by adding calcium carbide to water, and bubbling through a solution of copper sulphate to purify, and let into the reaction bottle, which has no outlet. This bottle must be shaken, so plumb the acetylene delivery line with rubber tubing, so that it does not have to be removed.

After about 2 hours the beads start to adhere together, (shake occasionally) and paraldehyde begins to collect at the bottom of the bottle. Water is added, about 2.5 cc, at intervals during the formation. The yield is good and the passage of acetylene is continued for two days, then the contents of the bottle (yes, that includes the glass beads) is shaken with ether. The ethereal solution is separated, dried over anhydrous sodium sulphate, and distilled. Paraldehyde passes over around its boiling point of 124° when distilling. Although, not mandatory, the acetylene should be passed through a column packed gently with bleaching powder. This is cheap insurance to make a smooth pure reagent and a good yield.

Paraldehyde is a safe hypnotic, acting within 30 min and causing no undo effects on the heart. It does produce addiction, however, and should not be used frequently. Dosage: 2-8 ml, as a hypnotic.

### Chlorinated Aliphatics

#### Butal Chloral Hydrate

*Acetaldehyde.* Acetylene is prepared from dropping water on calcium carbide. It is purified by passing through copper sulphate solution and a column gently packed with bleaching powder. It is then led into a reaction flask containing 300 cc of 96% acetic acid and 9.5 g of mercuric sulphate in solution, keeping the temp at 30°. A water jacket condenser is positioned at the 2 o'clock position (see Figure 25) and is connected to two bottles containing ether, cooled externally by ice. The gas is passed at a moderate rate for 2 days, and a little water is added to replace what was lost in the reaction (1 to 2 cc occasionally). After the desired time has passed (at least one day, I suggest two), heat the reaction flask to 60-70° to distill all the aldehyde into the ether, dry the ether with anhydrous sodium sulphate, and filter.

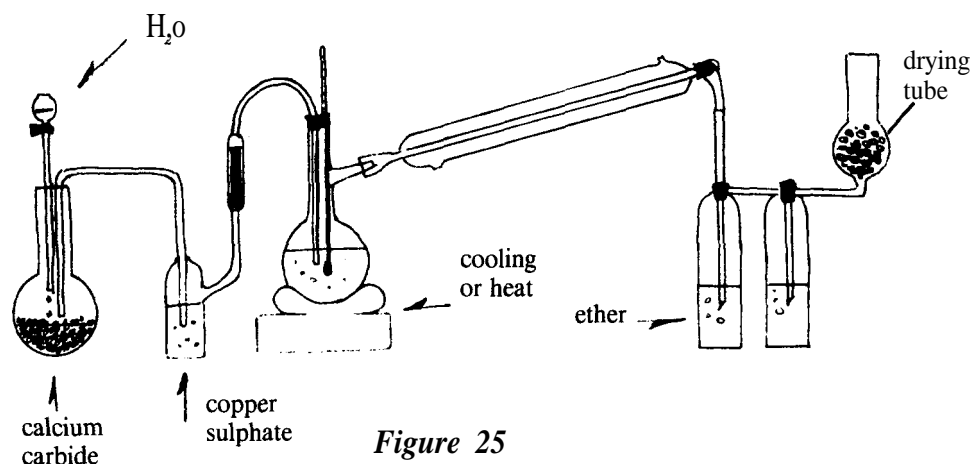

Figure 25

*Butal Chloral Hydrate.* Acetaldehyde is cooled to about -10° with a continuous current of dry chlorine passing through it. When the aldehyde is saturated, the temperature is slowly raised to 100°, while still maintaining a current of chlorine. The product is washed with sulfuric acid and fractionally distilled. Collect the fraction boiling at 163-165°, and redistill. Mix with one ninth of its weight of water, cool to precipitate, filter, and recrystallize with water. Butyl chloral hydrate is a hypnotic capable of analgesic effects. Dosage: 300 to 1,200 mg, mp 78°.

*Chlorobutol (Chloretone.)* 1 mole of dry acetone and 2 moles of chloroform is cooled to -10° with good, constant stirring. To this mixture add finely powdered KOH (20% by weight of

the above mixture), at a slow rate to keep the reaction temp below 50°. Continue to stir and cool for 24 hours more. Filter the mass and wash with acetone. The filtrate and washings are bulked and distilled, and the fraction boiling at 165-175° (as in most all formulas temp is measured in °C) is collected in water. The hydrate is filtered and recrystallized from aqueous alcohol (50% water + 50% ethanol).

Chlorobutol is a mild hypnotic with analgesic properties, used in seasickness, persistent hiccupping, and irritations due to chronic skin diseases. Dosage: 300 to 1,200 mg, mp: 77-78°.

## SULPHONES

*Sulphonal.* (Sulphonmethane.)

*Ethyl Mercaptan* 50 cc of coned sulfuric acid and 50 cc of 20% oleum are added to 100 cc of dry ethanol, with external cooling to keep the temp below 70°. Let stand overnight (12 hours) in a freezing mixture (below 0°), and pour onto a mixture of ice and 8% sodium carbonate solution, with good stirring. Concentrate the neutral solution until a crust forms on the surface (evaporate the concentrate).  $\text{Na}_2\text{O}_4\text{S}$  separates out and is filtered off. A 40% solution of caustic potash in water is saturated with  $\text{H}_2\text{S}$  (caution this is poison). The volume of this solution is 1 *Vi* times that of the filtrate, to which it is added and gently distilled. Ethyl mercaptan passes over at about 36°, it is shaken with a coned solution of caustic soda to separate ethyl sulphide. Ethyl mercaptan, after separating the oil, is precipitated by adding acid to the alkaline solution.

*Acetone Ethyl Mercaptan.* 50 g of ethyl mercaptan are added to 20 g of acetone and 6 g of anhydrous calcium chloride. Dry hydrochloric acid gas is passed into the reaction, while the temp is controlled to 25°, by external cooling. When saturated with acid, the mixture is allowed to stand for 12 hours, and is then washed with water. The resulting mercaptol is separated, dried with calcium chloride, and fractionally distilled. Unreacted ethyl mercaptan passes over first and is saved for a second run. Next, the mercaptol passes over at about 190°.

*Sulphonal.* 33 g of acetone ethyl mercaptol are added to 1 liter of 5% potassium permanganate solution, with good stirring. Let the reaction produce some exothermic heat, add 85 g of solid permanganate, at intervals, in small portions. Stirring is continued until the permanganate is reduced, when the solution is boiled and decolorizing carbon is added. After cooling the sulphonal separates out, is filtered, and recrystallized from aqueous ethanol.

Sulphonal is a slow, but long acting hypnotic. It is dangerous because it is cumulative and may produce porphyrinurea. Mp: 126°.

*Chloral Hydrate.* (An ethane derivative.) Chloral hydrate is one of the easiest drugs to make in this entire book. It is an effective hypnotic, that is rapidly absorbed from the stomach, and produces dulled sensory and motor functions, that last for 6 to 8 hours. The dose is from 250 mg to 1,500 mg. Chloral can be purchased at most any chemical supply house, eliminating the need for performing the first part of this synthesis. Chloral is not very suspicious (unless you're buying it by the 55 gallon drum), so you should have no trouble in making chloral hydrate directly from chloral.

Dry ethyl alcohol is saturated with dry chlorine, first at room temp for 24 hours, then at a boil, under reflux, for 24 hours. Take care not to allow atmospheric moisture into the reaction. Cool to get a crystalline mass, which is filtered and distilled with concentrated sulfuric acid to give crude chloral. To make chloral hydrate; you must purify the crude chloral by fractionally distilling and collecting the fraction, boiling at 97°C.

Treat one molecular portion of chloral with one portion of water (distilled). Heat will soon develop as pure, large, transparent masses on cooling in a refrigerator or freezer. These crystal masses are filtered soon after the reaction was initiated and then recrystallized with the minimum amount of water (boiling) that it takes to dissolve them. Mp: 57-58°.

*Note:* Chloral Hydrate is more commonly known as knockout drops. It really is not a recreational drug, and should not be used as such.

This section is obsolete,   
and should be ignored.

## BUYING PRECURSORS

Getting chemicals is not at all hard, even suspicious chemicals. Staying out of jail after buying watched chemicals and using those chemicals to make illicit dope, is very hard. I will tell you some very prized secrets that I have come to know along my long and winding road. These *secret* methods may not keep you out of jail, but they should improve your odds greatly.

### ***LEGAL METHOD***

I think your best bet is to go to a lawyer or someone else who may know drug laws; a pharmacist, a big chemical supplier, a lawman, the DBA (it may be wise to send someone else to talk with the law to get answers for you). After finding the drugs that are legal, you may make as much as you want, when you want, and how you want. It sounds like you've got it made, but you have to have the food and drug administration OK the drug for human consumption to sell it to the public legally. It is highly unlikely that will ever happen, so when you sell the stuff you are breaking the law. (Lilly and those other drug manufacturers must also follow strict codes.) It is much better to deal with the PDA and their laws, than with the DBA and their laws. Still, to keep the PDA off your back, you should follow the next method in conjunction with the legal method.

### ***PHONY BUSINESS METHOD***

This consists of finding a legitimate reason for buying suspicious chemicals and actually participating (to a small extent) in the mock business.

What kind of business? This depends largely on what kind of dope you plan to manufacture. Amine-type precursors go hand in hand with perfumery or dyes. Nitrating-type compounds (nitromethane, nitroethane) are also used as solvents, and rocket fuels. Indole has been used in perfumery. Tyrosine and tryptophan are nutrients added to feeds. Urea is a plant fertilizer and a feed additive.

Look in the *Merck Index* for the types of precursors you will be dealing with. Seven times out of ten there will be uses listed for these substances. Understand what these uses are for, and design your phony business accordingly. *Chemical Abstracts* sometimes list drug uses also.

Some businesses are all around good excuses for acquiring most any suspicious chemicals: Feed Additives for livestock and poultry; Plastic, Petrochemical, or Biomedical Research Laboratories; Analytical or Consulting Laboratories; Chemical Manufacturing Company and Chemical Supply

House, Scientific or Industrial. I will use some of these mock businesses in examples to give you some idea of what this will require from you.

1. Check with the city zoning to see if and how much livestock can be retained at your lab site. Most city ordinances allow several large (cattle) and many small (turkeys) size animals to be kept in city limits. Check before setting up your lab.
2. If you are making legal stuff, you may do so at your business lab. However, you need to *lose* (in your records) all that you have sold. For instance, you made 26 grams of A 3 THC (legal in most states), you sold 25 grams and saved one gram for testing on your chickens or mice. Along comes the DBA, they have been informed that you have purchased enough olivetol to make approximately one ounce of THC, so they get a search warrant and go through your lab. They find 800 mg of A 3 THC and ten chickens with a bad case of the munchies. The A 3 THC is legal, so they cannot bust you for manufacture, but after getting a search warrant they will look bad if they do not get a bust. Where's the other 25 grams, they want to know? If you are selling this for human consumption without the proper OK, in the slammer you go. Let's say you were smart, and in your notes or records wrote "reaction temperature became too high and decomposed trans verbenol, minimized yield to only 3% (one gram), gave chickens 20 mg dose each on 3/19/87." Now you have *lost* all that you sold and you have proof, as lab notes make great evidence in court.

Some states allow you to sell your legal drugs to individuals that will write and sign a letter stating that they are a professional researcher, who is using these substances on non-human subjects. You can also do this yourself, if you want a drug that is too hard or expensive to make yourself. Contact a big chemical supplier or a local chemical consulting manufacturing lab and send them a copy of your license and a letter like the one below (call beforehand to know something about the chemicals you want and how much they cost).

Date

Name  
Address

Dear Sirs:

I have been doing research on the dietary effects of certain drugs on cattle. Unfortunately, my laboratory is on a minute budget and is not set-up properly for the manufacturing of 5-methoxy-N, N-dimethyltryptamine, A3-tetrahydrocannabinol, and tropinone. I feel these are important substances to gain knowledge for my project, so please send me the following:

1 oz. (28g)	5-methoxy-N, N-dimethyltryptamine	@ \$ 920
1/2oz. (14g)	A3-tetrahydrocannabinol	@ \$ 675
2 oz. (56g)	tropinone	\$ 492
		\$ 2,087

Enclosed is a cashiers check for the total amount required, and a copy of my license. Please call me collect at (phone #) or write me at the address above if you have any questions. Thank you.

Sincerely,  
Name

This is also a good way to get precursors for hard to make items, but once obtained, can be changed into drugs quite easily.

3. If you are making illegal stuff, then you must have two labs, and you must be *very* careful. The phony lab is used for making precursors, preparing and/or purchasing reagents. Then, after making sure you are not being followed or you and your car are not wired (bugged), go to your secret lab and finish the last steps required of the formula. Some precursors may be enough to get you busted, so be careful of what you make and have some kind of excuse for making it. Also, you should not keep notes or records of illegal dope made. You should take notes of your operations, so you can go back and see what you did wrong if the formula fails, but after you are finished, destroy the notes. Keep records of *lost* precursors purchased through the mail as in rule #2. Example of your notes:

*Dropped and broke pint jar of Isosafrole, total loss. Used pint of isomyristicin in "Scent of Nutmeg Perfume" (formula # 3-A).*

4. When dealing with chemical supply companies, get a letter head and some business cards in your company's name. This will cost about \$30, and is worth it to make you look like a serious business. Use a high quality typewriter that can erase your mistakes. Use proper English and correct spelling.

Many large chemical suppliers have toll-free numbers to order or ask questions on (these are listed elsewhere in this book). Some also have credit accounts enabling you to order chemicals, make dope, sell dope, and pay them back after getting your money from the selling. The amount you are allowed to borrow depends on how you have been paying them back previously. So, get some credit established. Even if you have money, open an account and borrow as much as they will allow, then pay them back promptly to establish good credit. Large labs order thousands upon thousands of dollars worth of chemicals and take months to repay, because they have good credit. To see exactly what will be asked of you to open an account, see the customer account application example on page 110.

5. All legitimate businesses must collect a certain percentage of sales tax (unless your state, like Montana, does not have a sales tax) on every dollar they take in. Then, after every month or every four months, they must fill out a form (see the form on page 111) and send the state the total amount of taxes that you have collected from your customers. Sounds like too much work? It really is not, and it's well worth it to have a license or license copy to show chemical supply companies in proving your legitimacy. It will cost \$15 or \$20, but will be good for the life of your business. Call City Hall and make an appointment with someone who can help you get a license.

Most states allow deductions (reasons for not collecting taxes). I have no way of knowing every states reduction policy, so you will have to find out for yourself. I think most states cannot collect taxes for consulting, so add consulting to your business name (i.e. Plastics Research and Consulting). Then when you get your tax form write "0" in all the taxes collected and send it back. This makes things much easier, but if you can collect taxes, do it and record all amounts taken and send it in. Remember, you must play the role of the fake business completely.

6. After purchasing, even the not too suspicious items (like ether) from any supply company, you should begin to take safety precautions to prevent getting busted. Act as though the DEA is bugging your house, car, laboratory and phone. Act as though they are following

you and staking you out at all times. Never say or do anything that you would not say or do with a DEA agent standing next to you. President Reagan has funded millions of dollars to fight illicit drugs, thereby opening thousands of jobs for undercover agents and detectives.

Big Brother is among us, so make sure to check current laws to see if what you are making is illegal. If it is not illegal (i.e. ephedrine, A 3 THC) then make what you want, but don't get caught selling it for human consumption. If your drug is illegal, be careful of where you make the final product, remember how sophisticated police equipment has become. A transmitter could be planted on your car, that will not only tell where you are, but what you are saying.

<b>BILLING ADDRESS:</b>		<b>SHIPPING ADDRESS:</b>	
Name of Firm _____	Name of Firm _____	Address _____	Address _____
City, State, Zip Code _____	City, State, Zip Code _____	City, State, Zip Code _____	City, State, Zip Code _____
TELEPHONE # _____		TELEPHONE # _____	
<b>TYPE OF ORGANIZATION</b>			
<input type="checkbox"/> Corporation	<input type="checkbox"/> Partnership	<input type="checkbox"/> Sole Proprietor	
<input type="checkbox"/> Partnership	<input type="checkbox"/> Individual	<input type="checkbox"/> Foundation (Non-Profit)	
<input type="checkbox"/> Other (Please specify) _____			
<b>DATE OF INCEPTION:</b> _____			
<b>PRIMARY BUSINESS ACTIVITIES (Please check all appropriate boxes):</b>			
<input type="checkbox"/> Manufacturer of _____	<input type="checkbox"/> Consultants for _____		
<input type="checkbox"/> Medical/Clinical laboratory	<input type="checkbox"/> Wholesaler		
<input type="checkbox"/> Reference/Testing laboratory	<input type="checkbox"/> Retailer		
<input type="checkbox"/> Research/Development laboratory	<input type="checkbox"/> Other (Please specify) _____		
Primary SIC Code: _____	<input type="checkbox"/> Exporter _____	Country _____	
<b>NAMES OF PRINCIPALS AND/OR OFFICERS</b>			
_____			
_____			
<b>HOW WILL YOU USE OUR PRODUCTS?</b>			
<input type="checkbox"/> Laboratory research/development only	Activities regulated by the FDA as, or a component in,		
<input type="checkbox"/> As intermediates in the manufacture of _____	<input type="checkbox"/> a human drug		
<input type="checkbox"/> Resale under Aldrich labels	<input type="checkbox"/> an animal drug		
<input type="checkbox"/> Resale (in present form) under your label (including repacking)	<input type="checkbox"/> a cosmetic		
<input type="checkbox"/> Other (specify) _____	<input type="checkbox"/> a food		
	<input type="checkbox"/> an <i>in vitro</i> diagnostic (IVD) reagent		
	<input type="checkbox"/> as intermediates in manufacture of food, drugs, cosmetics, or IVD's		
<b>GIVE DETAILS OF ANY RELEVANT GOVERNMENT OR PROFESSIONAL REGISTRATION OR LICENSES (For example, registration with FDA, EPA, etc.)</b>			
We certify that the information given on this form is true and correct and that we fully understand the published Terms and Conditions of Sale of the Aldrich Chemical Company, Inc.			
Typed Name of Authorized Representative _____	Title _____		
Signature _____	Date _____		

<b>FINANCIAL DATA</b>	
If you are affiliated with any other companies or organizations, please list:	
Name _____	Name _____
Address _____	Address _____
City, State, Zip _____	City, State, Zip _____
Relationship _____	Relationship _____
Are you listed in Dun and Bradstreet? <input type="checkbox"/> yes <input type="checkbox"/> no	
If listed under a different location or affiliation, please advise Dun and Bradstreet No. _____	
Are you tax exempt? Tax exempt No. _____	
(Please attach certificate)	
Person to contact regarding matters of account _____	
Telephone # _____	
Check here if cash in advance or COD sales are acceptable until your account is approved. Cash or certified funds are required for COD shipments exceeding \$100.00 in value.	
<b>BUSINESS CREDIT REFERENCES</b>	
Name _____	City _____
Street Address _____	Zip Code _____
State _____	Account Number _____
Telephone Number _____	
Name _____	City _____
Street Address _____	Zip Code _____
State _____	Account Number _____
Telephone Number _____	
Name _____	City _____
Street Address _____	Zip Code _____
State _____	Account Number _____
Telephone Number _____	
Name _____	City _____
Street Address _____	Zip Code _____
State _____	Account Number _____
Telephone Number _____	
<b>BANK REFERENCE</b>	
Name _____	City _____
Street Address _____	Zip Code _____
State _____	Account Number _____
Telephone Number _____	
Person we may contact regarding your account _____	

*Customer account application*



**STATE OF**  
THE DEPARTMENT OF REVENUE AND TAXATION

Illustration #1—Sales Tax

REPORTING PERIOD

**NO CARBON IS PROVIDED. PLEASE ENSURE THAT  
BOTH SIDES OF THE ORIGINAL ARE COMPLETED.  
THE SECOND COPY IS FOR YOUR FILES.**

READ INSTRUCTIONS ON BACK BEFORE FILLING IN THIS FORM. TYPE OR PRINT CLEARLY

~~WIMI~~ ~~M~~

- 1. GROSS SALES AND SERVICES (INCLUDING ALL ALLOWABLE DEDUCTIONS)
- 2. TOTAL DEDUCTIONS (WORKSHEET ON REVERSE SIDE)
- 3. NET TAXABLE SALES (LINE 1 LESS LINE 2)
- 4. SALES TAX DUE AT 30,004.
- COLLECTIONS ON ACCOUNTS RECEIVABLE**
- 5. COLLECTIONS ON ACCOUNTS RECEIVABLE
- 6. SALES TAX DUE AT
- SALES OF 24c OR UNDER FOR WHICH DETAILED SEGREGATED RECORDS MUST BE KEPT**
- 7. TOTAL OF SALES OF 24c OR UNDER
- 8. SALES TAX DUE AT 1% .....

- 9. TOTAL PURCHASES FROM OUT-OF STATE VENDORS
- 10. TOTAL PURCHASES CONSUMED BY YOU ON WHICH NO TAX WAS PAID
- 11. TOTAL TAXABLE PURCHASES
- 12. USE TAX DUE AT

9  
10  
**JD**

**SALES TAX** SALES SUBJECT TO A DIFFERENT TAX RATE

13. SALES SUBJECT TO 4% TAX RATE

14. SALES TAX DUE AT 4%

500,000 **IB** 10,000

15. PURCHASES SUBJECT TO 4% TAX RATE

16. USE TAX DUE AT SALES SUBJECT TO A DIFFERENT TAX RATE

17. SALES SUBJECT TO

500,000 2,500

18. SALES TAX DUE AT PURCHASES SUBJECT TO A DIFFERENT TAX RATE

19. PURCHASES SUBJECT TO 6% TAX RATE

30. USE TAX AT 5%

**J\_ID**

21. AMOUNT OF EXCESS TAX COLLECTED (SEE REVERSE SIDE) .....

22. AMOUNT OF ADDITIONAL TAX COLLECTED (SEE REVERSE SIDE) .....

23. TOTAL OF ALL TAXES DUE ON THIS RETURN (TOTAL OF 4, 6, 8, 12, 14, 16, 18, 20, 21, 22) .....

24. PENALTY FOR LATE FILING (SEE REVERSE SIDE) 10% OF LINE 23 .....

20	ED
ED	ED
<u>15,000</u>	ED

25. INTEREST OF 1% OF LINE 23 FOR EACH MONTH OR FRACTION THEREOF PAST DUE DATE

**ig**

26. TOTAL TAXES PENALTY AND INTEREST TO BE REMITTED WITH THIS RETURN (ADD LINES 23, 24 AND 25)

75,000

**MAKE CHECKS PAYABLE TO THE DEPARTMENT OF REVENUE AND TAXATION**

PLEASE NOTE IF THIS RETURN IS THE LAST ONE FOR YOUR BUSINESS PLEASE FILL IN BUSINESS DISCONTINUATION AREA ON THE REVERSE SIDE OF THIS RETURN.

SIGN HERE

KNOWLEDGE AND BELIEF

You have been working in your phony business all week to make many batches of olivetol and menthadienol. You have covered your tracks well and all your phony records are in order. Then a dear friend comes in, he asks if you need help on the final batch. The guy can be trusted with your little sister (who happens to be a 17-year old virgin), so you tell him you will stop by and get him because you do need help. The DEA has somehow bugged your lab and from this information, they put a transmitter on your car. Then they hear you tell your friend all about how you are going to make this illegal dope on the drive out to your secret lab. They get a helicopter and follow the transmitter to you and your lab, and you then get five to ten years in the federal penitentiary.

How would you avoid a situation like this? Use common sense; never say anything that does not apply to the mock business, at anytime or anyplace; ditch your car at an airport and rent a car; never develop steady patterns or habits; use a lot of patience; shut down the illicit part of your operation if at all nervous; keep an eye out for surveillance vehicles; invest in a bug detector; never get a partner that you haven't known for at least six years; etc.

7. Make and sell major precursors (nitropropene, olivetol, ergotamine, etc.) to people you can trust. Some states have restrictions and requirements on selling precursors, so be careful. Let them do the final reaction and let them take the risk out of getting busted. If you charge too much, they will not deal with you. I have heard of an operation like this making quite a nice profit, while posing as a consulting lab. They were subject to several *shake downs* (the DEA confiscating and analyzing lab items, search and seizure) because of the mass quantities of reagents and precursors that they had purchased from the major suppliers. But, because they had not synthesized any controlled substances, they could not be busted. All their chemicals and equipment were returned with an apology.
8. Other restrictions depend on what your phony business is all about and on federal and state restrictions or requirements. The Food and Drug Administration controls animal drugs, human drugs, cosmetics, certain drug intermediates, food, etc.

If your products are not used to sell to the general public (if they are used as reference, in experiments, or on test animals that will never be sold to the public) then the PDA will not interfere. Check with the PDA, a lawyer, or someone that knows before getting any licenses.

### ***THE TRAVELING FALSE IDENTITY METHOD***

This consists of setting up a lab inside a motorhome, buying chemicals in one state, and traveling elsewhere to make and sell dope in the self-contained unit. A mobile lab is about the best way to beat the law, but you will have to get some kind of mobile home, 5th wheel trailer, or pull behind trailer, which requires a good bit of capital to get started. I have heard of people buying their chemicals in one state and travelling to another to set-up makeshift labs in rented mountain hide-a-ways, therefore eliminating the need of a trailer.

Some things to remember:

1. The trailer or motorhome that you build your mobile lab out of must be modified greatly to work effectively and safely as a laboratory. You must:
  - (a) tear out all of the carpeting and lay down a flame-proof floor.

- (b) tear out most or all the cabinetry and hang flame-proof walls (sheetrock or wallboard is flame resistant, easy to work with, and cheap). You will probably have to strengthen the existing framework to support this.
  - (c) hang flame-proof or flame-resistant material to the ceiling.
  - (d) build the workbench into the camper in an orderly professional manner (see equipment chapter).
  - (e) you may have to increase electrical and water-heating capacities, refrigerator space, etc.
2. Where to park. Parking out in the middle of Nevada's badlands would be ideal, but this type of place gives no water, sewer, or electrical hook-ups, thereby creating the need for a larger or secondary water tank, and a reliable generator. Also, stay away from fishing and hunting areas, as you will run into game wardens who can legally search your vehicle or trailer anytime they desire, and legally take you to jail for drugs.

If you park at a trailer-type park with electric hook-ups and water you will most likely have neighbors. Do your work late at night so pungent or obvious odors (like ether) do not reach any outside noses. Try to work with precursors like isosafrole, which smells like black licorice, or some of the good smelling precursors. Good odors are not as suspicious as bad or strange odors.

3. Identification is a must. All chemical supply stores require signatures on certain precursors and chemicals. Usually you will have to show a valid driver's license to prove you are not signing a fictitious name, making false identification a must.

Loompanics Unlimited has many fine books on acquiring false identity at a very reasonable cost. It would be a good idea to purchase a book written specifically for that subject, to learn the finer points of false identification. Also, in the back of *High Times* magazine, I have seen several companies that will send you a fake drivers license for around \$10. Personally, I would make or buy a fake birth certificate. Take the certificate down to the examiner, tell him that you have never had a driver's license before, pass your test and get a second or third license with false names. To make a fake birth certificate, take your old one to a printer and have him duplicate several like yours without the information. Simply type in the information you will use to buy chemicals. Some of the fake driver's license companies also sell fake birth certificates.

4. The purchase of chemicals. Never, ever drive the mobile lab to the chemical supply store, take a cab, rent a car, ride a bicycle, walk, or do whatever it takes. The DEA stakes these places out and follows customers back to their illicit laboratories, so make sure you go through great lengths to lose trailing lawmen. Usually the smaller chemical supply stores will not have all the things you need, so you will have to hang out for a week or so until it comes in. Call to see if your order is in, do not go to the store until everything is ready for you to pick up (staying away from these places until you really need to be there will prevent you from being followed).

When ordering directly from the big outfits through the mail, always use a private mail drop, mail forwarding service, or post office box. Always keep a great deal of distance between your mail drop off point and your mobile lab to give you room to elude anyone who may be following you.

5. Rules that are never broken:
  - (a) never make a laboratory in a trailer, motorhome or mobile home without fire-proofing as described previously. These things burn at an alarming rate and laboratory fires are quite common.
  - (b) never sleep in the unit while doing any type of operation (even a simple reflux). Pitch a tent nearby or get a motel room. Even if you have a bedroom with a good door located at the far end of the trailer away from the laboratory section, sleeping is still forbidden.
  - (c) never give the law reason to pull you over. This means to have your trailer licensed and inspected before you build the laboratory into it. Make sure your brake lights, tail lights, and turn signals all function properly at all times. Do not go over the speed limit or commit any other traffic violations. Always drive defensively. If a drunk runs into your mobile lab, I believe you are in for one hell of a fire or explosion, and when the law investigates, they will probably find enough evidence to bust you.
  - (d) never let sparking electrical motors, electrical switches or open flames from gas devices be allowed anywhere in or on the trailer without being mounted in vapor-proof boxes. Heater ducts that lead to a furnace can lead to explosions. Vapor-proof a section of trailer to be lived in and make sure this is the only part of the trailer to be heated.
6. Boats may be used for mobile laboratories, but I feel this is a bad move because of fire hazards at sea and because the Coast Guard has stepped up their drug smuggling operations considerably.

# MAKING PRECURSORS

This is the best way to keep from being on the DEA's watched list. If your lab is totally self-sufficient, then it is doubtful that you will have a chemical supplier give your name over to a law official, but it would still be a good idea to use false identification and some of the other methods in the buying precursors chapter, in conjunction with making precursors, as you can never be too careful when dealing with the law. When you make your own precursors, you still have to get starting materials. These are not nearly as suspicious as the watched precursors (chemicals that supply houses are required by law to report being purchased), but you can never be too careful.

There are millions of different precursors for thousands of different drugs, making it impossible for me to list all of them. I will stick with the more commonly called for items. If you need to find something that I have not listed, look in the *Merck Index* or *Chemical Abstracts* to find a reference of where the synthesis of this precursor can be found. At the end of the formulas given here, I have listed some hints or ways to get good precursors out of over the counter medication, like cough syrup, asthma pills, motion sickness pills, etc. Some of these precursors are psychoactive as is, such as ephedrine.

I would like to tell you a story, to show you how you can be busted by making drugs from over the counter medicine. Two guys I knew were going down to the local Gibsons and ordering Vicks inhalers by the case, because back in those days Vicks was putting things like methylamphetamine into those inhalers to clean out stuffy sinuses and these guys knew that. It is very easy to remove the drug from the inactive crap. They removed the amphetamine and sold it, making one hell of a big profit. As a matter of fact, they could not get enough to sell to all their buyers, so they went to a drug store, after exhausting all the big discount type stores. The pharmacist on duty, after eight years of college, knew exactly what is in the inhalers that cleared out clogged sinuses, so when these two guys came in and bought every last inhaler, he called the law. Sales for the two guys kept on rising, they returned to the drug store and purchased several more cases of inhalers, were followed to their laboratory by the DBA, and although they were not actually making it (they were just extracting it, as it was already made), they were busted for manufacture. I think those two guys are still doing time. I will describe how these over the counter drugs are removed, later in this chapter.

Here are some intermediates or precursors you may need to make to complete some common drug formulas. If you do not find what you are looking for here, look in the *Merck Index* to get a reference for the synthesis to the compound you need.

*Methylindole.* 1 mole (30 g) of phenylhydrazine is mixed with 18 g (a little more than 1 mole) of freshly distilled acetone (bp: 56-58°). This mixture will become very warm and a lot of water will separate. Heat the mixture on a water bath for 16 min, testing a small portion occasionally

with Fehling's solution. If the phenylhydrazine is still present in excess, the Fehling's solution is reduced. More acetone must be added, from time to time, until the reducing action has almost ceased. The crude acetone-phenylhydrazine (a turbid oil) is placed in a large crucible, and the excess acetone is removed by heating on a water bath. 200 g of anhydrous zinc chloride is added and the mixture is heated on the bath, with good stirring. This mixture is then heated to 180° on an oil bath, and after a few min, the mass will acquire a dark color. After this color change, the crucible is removed from the oil bath and stirred. The reaction is complete in a short time and is followed by a change in color of the fusion product and evolution of vapors. The dark fused mass is treated with 3<sup>1</sup>/<sub>2</sub> times its weight of hot water and distilled in steam after it has been acidified with a little hydrochloric acid. The product distills rapidly. This solid is filtered off, melted to free it from water, and distilled. Store in an air tight bottle. Yield: 19 g, mp: 59°, bp 272°.

*Acetic Anhydride.* 100 g of crystallized sodium acetate is heated on a stainless steel tray until the crystals melt in their self-developed water. This water evaporates off and the mass solidifies, the heat is increased slowly until the mass melts again, taking care not to char the substance with too much heat. At 315° the entire mass will fuse, it is cooled, powdered and added to a 250 cc distillation flask fitted with a water condenser that is connected to a two necked flask that has a calcium chloride drying tube in the free neck. This entire apparatus is rigged up in a fume cupboard. 1 mole (40 g) of acetyl chloride is slowly added through the free neck of the distillation flask, which is cooled in water and shaken occasionally or stirred by using a three necked flask and a mercury sealed stirring device. When the addition is complete, the dropping funnel can be removed, and a mercury sealed stirring device can be installed, or if already equipped, the third neck may be stoppered. Heat evenly (in a deep oil bath) until nothing more distills. Add some fused sodium acetate to the distillate and redistill from this receiving flask into another distilling flask, which has had the air displaced with dry air (this is accomplished by blowing air through the drying tube into the apparatus with a rubber bulb). This flask should also have a drying tube, as the one before it had. The fraction distilling at 130-140° is collected separately. Yield: 45 g of clear liquid. *Note:* If a more pure product is desired, the distillation over sodium acetate (fused) must be repeated several more times.

*Anthranilic Acid.* Anthranilic acid can be made several different ways. The following is, in my opinion, the easiest. 20 g of aceto-o-toluidide and 50 g of magnesium sulphate are dissolved in 2<sup>3</sup>/<sub>2</sub> liters of water. Heat this mixture to 80° and add 60 g of finely-powdered (solid) potassium permanganate, with good stirring. After the addition, raise the temp to 85°, and continue stirring at this temp for 2 hours. Remove the permanganate by adding alcohol (this removes the unreacted permanganate), and filter the solution, hot. Acidify the filtrate with dilute sulfuric acid and the acetanthranilic acid will precipitate. This precipitate is purified by reprecipitation from alkaline solution. It is then hydrolyzed by boiling with an excess of dilute HCl acid and recrystallized from hot water.

*Benzaldehyde.* There are many ways to make many types of benzaldehydes. Different benzaldehydes give different products. I am giving the formula to the basic type. It can be modified to give a specific type of benzaldehyde. 50 g of benzyl chloride and 50 g of copper nitrate in 300 cc of water are refluxed together, in a current of carbon dioxide for 8Vi hours or until a sample tested contains very little chlorine. Extract the mixture with ether, remove the ether on a water bath, and stir or shake the remaining oil for 1 hour (shaking is best) with a saturated solution of sodium bisulfite. Let stand for 2 hours, filter with vacuo and wash with a little cold alcohol, then with cold ether. The washings are warmed with an excess of 10% sulfuric acid. The aldehyde

that will separate is extracted with ether, the extract is dried over anhydrous sodium sulphate, remove the ether on a water bath, and distill the residue in a current of carbon dioxide, retaining the fraction boiling at 176-181°. Yield: 17 g, bp: 179°.

*Bromobenzene.* Add 10 drops of pure pyridine to a mixture of 30 cc of benzene and 20 cc of bromine in a 200 cc flask. The flask is rigged to an upright condenser, which has its opening connected to a delivery tube, that is connected to an inverted funnel, that is about 1/4 submerged in water. The reaction mixture is warmed to 25-30° until a vigorous reaction, which is necessary, subsides. Raise the temp to 70° and hold this temp until the evolution of hydrogen bromide stops. Cool the product, transfer to a funnel, and treat with dilute caustic soda solution by shaking until just barely alkaline. The heavier layer of bromobenzene is separated, dried with calcium chloride, decanted from the drying agent and distilled. The fraction boiling at 150-160° is retained. Yield: 28 g, bp: 154°.

*Chloral.* 100 cc of absolute alcohol are placed in a retort (a retort is a vessel capable of distilling or decomposing a product), which has a reflux condenser connected at a slant. A current of dry chlorine is passed into the alcohol with external cooling to keep the temp at 5-9°. The chlorine gas is absorbed rapidly, then the absorption begins to decrease noticeably. The retort is heated to 60° and the chlorine is still passed through, as long as it is being absorbed. The liquid is then boiled gently and cooled. An equal volume of coned sulfuric acid is now carefully added, causing the evolution of ethyl chloride and HCl acid. This mixture is distilled from a water bath, the distillate is neutralized with chalk and distilled again, and finally fractionated, the fraction boiling at 95-100° being retained.

*Chloral Hydrate.* Mix chloral with one fifth its weight of water and the mixture slowly solidifies to a crystalline mass of chloral hydrate.

*Cyclohexanone.* 20 g of cyclohexanol is placed in a flask and to it is added a 30° mixture of 41 g of potassium dichromate, 200 c of water and 19 cc of coned sulfuric acid. Shake and cool to keep the temp below 60°, but not less than 55°. After some time, the temp will remain steady, it is then heated to 60° and cooled at room temp for 1 hour. The mixture is then added to 200 cc of water and distilled until 100 cc have been collected. Add about 24 g of sodium chloride and shake. Let stand, separate the lower layer and extract it with ether. The extract is added to the cyclohexanone upper layer, dried over anhydrous sodium sulphate, filtered, and distilled, collecting the fraction at 150-155°. Yield: about 12 g of the colorless liquid.

*Diazomethane.* Diazomethane is a yellow, toxic gas. You must never use ground glass joints or cracked or chipped glassware as this will trigger an explosion. I will give an intermediate first.

*Nitrosomethyl urea.* 20 g of methylamine hydrochloride (see below for formula) and 30 g of potassium cyanate are dissolved in 120 cc of water, heated to 70° for 15 min and then to boiling for a few min more. Cool to 0° and add a solution (also cooled to 0°) of 20 g of sodium nitrite in 40 cc of water. 100 cc of 25% sulfuric acid is added, with stirring. The nitrosomethylurea separates, is filtered, washed with ice water, pressed, and dried under vacuo. Crystallize from methanol to get light yellow needles.

*Diazomethane.* This formula is designed for immediate use. 10 g of nitrosomethylurea is added (with continued shaking) in small portions to 100 cc of ether and 30 cc of 40% caustic potash, in a wide mouthed flask and cooled to 0°. This must be done very carefully in a fume cupboard. After 10 min, the yellow ethereal extract is separated, and dried for 3 hours with a little solid caustic potash. This ethereal solution of diazomethane should not be kept for more than several days, and for preparative work, it is used in solutions only.

*General Procedure for Methylation with Diazomethane.* The ethereal solution as prepared above is added to a suspension or solution of the compound to be methylated. Reaction is indicated by the disappearance of the yellow color, and is completed when the color persists on warming. Nitrogen will be evolved and the product is recovered from the ethereal solution.

*Diethyl Ether.* This is also called ethyl ether or ether and must not be confused with petroleum ether. If, for example, you see a formula calling for ether, then it refers to diethyl ether, if it does not specify petroleum ether, then do not use petroleum ether. 100 g of ethanol (dry ethanol is best) is placed in a  $\frac{1}{2}$  liter distilling flask, and with good cooling, 180 g of coned sulfuric acid is added slowly. This flask needs a thermometer fitted, so that the bulb dips down below the liquid, and extend the addition funnel, so that the ethanol can be added below the surface of the acid. Heat and maintain the mixture's temp at 140-145° by heating on a sand bath. Ethanol is run in from the addition funnel at the same rate as the liquid distills over (about 2 drops per second). Mark the flask before distilling, so that you can be sure of the addition rate. After about 150 g of alcohol (ethanol) has been added, stop heating. The distillate will require the following purification steps: Shake twice with 50 cc of 10% caustic soda solution, to free from sulfuric acid. Shake twice with 50 cc of saturated sodium chloride solution, to free from ethanol. The ether is then dried over anhydrous calcium chloride for 24 hours and distilled on a water bath, collecting the fraction boiling at 35°. Yield: 100 g.

*Anhydrous Ethyl Ether.* This is for those formulas calling for dry, pure, or anhydrous ether. The ether product from above is dried over thin slices of metallic sodium (metallic sodium wire works well also) for 24 hours. Then the ether is distilled on a water bath, over fresh (fresh means a different batch than what you used to dry with) metallic sodium. *Note:* Ether develops explosive peroxides upon sitting for any length of time, even if just purchased from a supply house. Therefore, before handling ether, which has been stored, shake with ferrous sulphate or with lead peroxide. To keep peroxides from forming in fresh ether; add several sections of copper or iron wire to the dark container and store in a cool place.

*Hydriodic Acid,* 11 parts (by weight) of iodine is placed in a small flask, and 1 part of yellow phosphorous, cut into small pieces and dried, is gradually added. Expect a flash of light and the contents to turn liquid upon the addition. When all the phosphorous has been added, phosphorous tri-iodide is to be separated upon cooling. The product is treated with  $\frac{1}{2}$  parts water, heated gently to produce hydrogen iodide, which is passed over some red phosphorous, that has been moistened with a little water and placed in a U tube. Heating is continued until the liquid just becomes colorless, because if heating is continued further, phosphine and phosphonium iodide are formed, which can cause a powerful explosion. If you require a solution of hydriodic acid (most formulas do), the gas is led through an inverted funnel into a small quantity of cold water. This solution if dilute can be coned by distillation. Bp: 127°.

*Malonic Acid.* 100 g of powdered chloroacetic acid is treated with 150 g of broken ice and dissolved in 125 g of caustic soda (33 $\frac{1}{2}$ % solution). The solution should be made exactly neutral, if it is not already (this refers to the mixture). After neutralizing, add 69 g of 98% potassium cyanide in 130 g of water, which has been warmed to 40°. An hour after the addition, the mixture is slowly warmed to 100° and held at this temp for an hour. Cool slowly to 25° and add another 125 g of 33 $\frac{1}{2}$ % caustic soda solution. Slowly heat the mixture to 100° and hold at that temp until no more ammonia is evolved (2 to 3 hours). To test: add sodium hydrate solution to a sample and boil. If no ammonia evolves, then the reaction is complete. When the reaction is complete, the solution is cooled, acidified with dilute HCl acid, and carefully evaporated to complete dryness on a water bath. The residue is powdered, extracted repeatedly with ether, and the ether



is removed by gently heating on a water bath. You may purify further by dissolving in the minimum amount of caustic soda solution, boiling with decolorizing carbon, acidifying and extracting with ether, as before. Yield: 95 g, mp: 132°.

*Methylamine Hydrochloride.* 125 g of ammonium chloride and 250 g 40% aqueous formaldehyde solution are placed in a distilling apparatus, with the thermometer well below the surface of the liquid. The mixture is slowly heated to 104° and held at this temp until no more liquid distills. The product in the flask is cooled and filtered from ammonium chloride. The liquid is then evaporated on a water bath to half its original volume and a second crop of ammonium chloride is filtered off. The filtrate is concentrated at 100° until a crystalline scum forms on the surface. On cooling methylamine hydrochloride separates and is removed by filtration. Further evaporation and cooling produces another crop of methylamine hydrochloride, which is also filtered. The combined yield is treated with boiling chloroform, filtering hot, washed with room temp chloroform, and dried in a vacuum desiccator. Yield: 40 g.

*Fuming Nitric Acid.* This is easily prepared by distilling 2 moles of sodium nitrate with 1 mole coned sulfuric acid at over 200°.

*Nitroethane.* 42 g of dry silver nitrite is placed in a flask fitted with a reflux condenser. *Note:* To recover the by-product (ethyl nitrite) ice water must be used in the condenser, which needs to be a long one. Gradually add 34 g of ethyl iodide, so that the mixture does not boil too violently (it should boil vigorously). Do not shake or disturb the flask during this procedure. After the addition, reaction has subsided, warm the flask for 2 hours on a water bath, cool well, and fractionally distill after rigging the apparatus to do so. Ethyl nitrite distills over at 68° and is collected in a below freezing mixture. Nitroethane distills over at 110-114° and must be redistilled once more. Yield: 8-9 g.

*Nitromethane.* 103 cc of 40% sodium hydroxide solution is added, slowly with stirring, to a mixture of 100 g of chloroacetic acid and 100 g of crushed ice until the mixture is just barely alkaline to phenolphthalein. Keep the temp between 10-20° during this addition. 73 g of sodium nitrite in 100 cc of water is added and the whole is heated in a 500 cc flask, rigged to a distillation apparatus that has the thermometer immersed in the liquid. Distillation of nitromethane starts at about 87° and continues to come over to 108-110°, which is where the temp is maintained for 30 min. Nitromethane is separated from the aqueous layer of the distillate in a separation funnel and is distilled three more times, being separated from the aqueous layer after each distillation. The nitro is then dried over calcium chloride and distilled again, collecting the fraction boiling at 98-101°. Yield: 27 g.

*Phenylacetic Acid.* 50 g of benzyl cyanide and 150 g of 80% sulfuric acid are placed in a <sup>1</sup>/<sub>2</sub> liter flask, connected to a second <sup>1</sup>/<sub>2</sub> liter flask by a glass tube that is bent twice at right angles. The second flask is fitted with a two holed stopper, in which the glass tube is flush with the stopper in one of the holes. Through the second hole a vertical glass tube, 50 cm long, dips just below the surface of 250 cc of water in this second flask. In the middle of this vertical tube, a large bulb is blown or a drying tube can be connected and stoppered with a one hole stopper, to allow the glass tube to be continued upward 25 cm. In a fume cupboard, the mixture is heated gently until small bubbles rise from the surface of the lower layer of acid. In a few min a vigorous reaction begins, the liquid in the flask boils, and a small quantity of benzyl cyanide distills over into the second flask, forcing some water up into the bulb. When the reaction is over, the flask is again heated for 3 min and allowed to cool, its contents solidifying in doing so. The solid residue is washed in cold water, dissolved in hot water, neutralized with sodium carbonate, filtered hot,

the filtrate is acidified with dilute sulfuric acid, and allowed to stand. The crystals which separate are filtered off, washed with cold water, and recrystallized from hot water. Yield: 46 g, Mp: 76.5°.

*Phenylacetoneitrile.* A slurry of 2,4,5-trimethoxybenzoic acid (100 g) or analog (3,4,5-trimethoxybenzoic acid, etc; see amphetamines chapter for synthesis) in 1 liter of dry benzene is gradually added to a stirred mixture of 38 g of LAH in 1 liter of dry Et<sub>2</sub>O. The mixture is heated under reflux for 4 hours, cool, and decompose with H<sub>2</sub>O and dilute H<sub>2</sub>SO<sub>4</sub>. The Et<sub>2</sub>O-C<sub>6</sub>H<sub>6</sub> layer is separated and washed with water, then dilute with Na<sub>2</sub>CO<sub>3</sub> and water. It is then dried with MgSO<sub>4</sub> and filtered. The filtrate is treated with 5 ml pyridine and then 75 ml of SOCl<sub>2</sub> is then slowly added. The mixture is stirred for 2 hours and poured into ice water. The organic layer is separated, washed with water, then with Na<sub>2</sub>CO<sub>3</sub>, again with water, dried with MgSO<sub>4</sub>, filtered and the solvents are evaporated off. The oily residue is dissolved in 700 ml of Me<sub>2</sub>CO and stirred with a solution of KCN in 300 ml of H<sub>2</sub>O. The Me<sub>2</sub>CO is evaporated and the residue is extracted with Et<sub>2</sub>O. The extraction is washed with water and dried with MgSO<sub>4</sub>. The Et<sub>2</sub>O is removed by evaporation and the residue is distilled under vacuo to get the substituted phenylacetoneitrile, which comes over the condenser at 128-133° at 0.25 mm of vacuum. Yield: 24 g. *Note:* *Psychedelic Chemistry* by Michael Valentine Smith has several different ways to make this product, it can be purchased from Loompanics Unlimited for \$14.95. This substance can be reduced to an active amphetamine by any of the reductions in the reductions chapter.

*2,5-Dimethoxybenzaldehyde or 2,4-Dimethoxybenzaldehyde or Veratraldehyde.* Equimolar quantities of phosphorus oxychloride (1 mole = 153 g) and N-methylformanilide (1 mole = 135 g) are placed in a 1 liter, three necked flask and allowed to stand for 45 min. To this mixture is added, over 70 min with stirring, and cooling at 25°; 1 mole of 1,4-dimethoxybenzene (to get 2,5-dimethoxybenzaldehyde); or 1 mole of 1,3-dimethoxybenzene (to get 2,4-dimethoxybenzaldehyde); or 1 mole of veratrole (to get veratraldehyde). After the addition, the procedure must be changed for 2 of these products. I will give the procedure for 2,4-dimethoxybenzaldehyde first.

After the addition of the 1,3-dimethoxybenzene is complete, the cooling bath is removed and the mixture is stirred for 3 hours longer, during which time the temp rises to 34°. The resulting syrupy red mixture is allowed to stand overnight (or 12 hours) and is then poured slowly into 2.5 liters of cold water, with good stirring. The resulting solid is filtered off and washed with cold water on the filter. This wet cake is dissolved in 250 ml of warm benzene, and the aqueous layer is separated and shaken with 50 ml of benzene. The combined extracts are concentrated and distilled from a Claisen flask at about 110° under 0.1 mm of vacuo to yield 141 g of 2,4-dimethoxybenzaldehyde. Mp: 68-70°.

2,5-Dimethoxybenzaldehyde and veratraldehyde use the same procedure, which follows. It should be noted, that the poor yields of these two products can be improved considerably by using 0.2 mole scale instead of 1 mole, as described above. You will have to change the reagent quantities to 0.2 mole also, the reaction times will remain the same as will the temps.

After the 70 min addition, at 25° with good stirring, is complete, the cooling bath is removed and the mixture is heated, with stirring, at 70° for 18 hours. It is then poured into water and ice and the product is extracted with ether. The extract is shaken with sodium bicarbonate solution, dried and distilled under 21.0 mm of vacuo. Yields: veratraldehyde, 12.5 g (38%), 2,5-dimethoxybenzaldehyde, 16%. For a better yield see CA, 44, 6831, b.

*Quinine Sulphate.* 90-100 g of cinchona bark is ground up with 250 cc of milk of lime. Evaporate to dryness on water bath, cool, and powder. Shake this powdered residue with 200 cc of chloroform and allow to stand in a flask for 12 hours. Filter and wash with chloroform.

Remove the quinine from the chloroform by shaking with dilute sulfuric acid a few times, and then with water until the aqueous solution no longer exhibits a blue fluorescence. The acid and aqueous extracts are carefully neutralized with ammonia, and the whole is evaporated on a water bath until quinine sulphate begins to separate out. It is cooled and filtered off. Another crop may be obtained by concentrating the mother liquor and filtering again. Recrystallize from water. Yield: 1-2 g. The free base can be isolated by dissolving the sulphate in water, acidifying with dilute sulfuric acid. Excess of sodium carbonate solution is then added when the quinine is precipitated. It is filtered off, washed and dried.

*Phenylethyl Ketone.* 200 g of finely powdered anhydrous aluminum chloride is suspended in 300 g of dry benzene in a flask that is cooled and equipped with a good stirring device. A mixture of 126 g of propionyl chloride and 105 g of benzene is added dropwise, with stirring, over 3 hours. After the 3 hours, the reaction mixture temp is kept at 50°. The contents of the flask are cooled and poured over crushed ice. Add 50 cc of coned HCl acid and remove the phenylethyl ketone and benzene by distillation with steam at 200-220° to yield 152 g of the ketone.

*Sulfanilamide.* This preparation should be conducted in a good fume cupboard. 36 g of chlorosulphonic acid (caution) is put in a dry flask and cooled below 15°, but not below 10°, in an ice bath. 7 g of finely powdered, dry acetanilide is added in small portions, with good stirring, the temp now being kept between 17-20°. When all, but a few particles of the acetanilide, have been dissolved, the flask is covered with a watch glass (a small sheet of thin glass) and placed in a hot water bath (65°) for 1 hour. The mixture is carefully poured (caution) in a thin stream into 150 g of crushed ice and stirred with the addition of some water to facilitate mixing. The whitish mass is broken up, filtered, and washed with cold water. 25 cc of coned ammonia are added and stirred into a paste, then heated to 70° for 30 minutes. Cool in an ice bath, acidify with dilute sulfuric acid, test with Congo Red, cool further, filter, wash with ice water, and dry in a steam oven (these are easily made). This is weighed and treated with 2 cc of dilute hydrochloric acid (dilute = 1 volume coned acid to 2 volumes water) to every gram of substance. This mixture is boiled, under reflux, for 1 hour on a sand bath, taking care not to char or burn. The solution is mixed with an equal volume of water and a little decolorizing charcoal (carbon), then heat to boiling and filter. Add solid sodium carbonate to the filtrate in small portions until just alkaline to litmus. The amide separates and after cooling in ice, is filtered, washed with cold water, and dried to yield 4 g of colorless needles that are recrystallized from water. Mp: 163°.

*Thiourea,* 50 g of ammonium thiocyanate is melted in a round bottom flask, in a paraffin bath, and kept at a temperature at which the mass remains just liquid (about 145°) for 5-6 hours, or at 170° for 1 hour. The first method gives a better yield. The cooled melt is powdered and ground up with half its weight of cold water, which dissolves unchanged ammonium thiocyanate, but not thiourea. The residue is filtered off and recrystallized from hot water. Yield: 7-8 g, mp: 172°.

*o- and p-Toluenesulphonic Acids and Their Separation.* 130 g of toluene is heated with 450 g of coned sulfuric acid in a cast iron pot, fitted with a stirring device. One crystal of iodine is added and the temp is raised to 100°. The sulphonation is complete after about 6 hours, then the reaction mixture put in a large basin, diluted with water, and milk of lime is gradually added to neutralize the excess acid. The calcium sulphate and any ferric hydroxide is removed by filtration and is washed with hot water. The filtrate is treated with sodium carbonate until just alkaline to phenolphthalein and the calcium carbonate is filtered off. The filtrate is then evaporated to near dryness when the sodium salts of o- and p-sulfonic acids separate out. Yield of both o- and p-toluenesulfonic acids: 340 g.

*Separation.* The product from above is treated with an equal weight of finely powdered (pulverized) phosphorous pentachloride. When the reaction is complete, cold water is added, while the whole is cooled externally by a freezing mixture. The p- derivative separates as a solid (mp 69°) and is recrystallized from ethanol. The o- form is an oily liquid that can be separated in a separation funnel.

*o- and p-Toluidines.* This should be performed in a strong vessel, that can be easily cleaned, that can be equipped with a powerful stirring device, and that can be fitted with a reflux condenser. This reaction can be modified to use tin instead of iron. 60 cc of water and 120 g of fine, cleaned, iron powder are placed in the reaction vessel and vigorous stirring is begun. The vessel contents are heated to 90-95° and 10 cc of HCl acid is poured in. 100 g of nitrotoluene is now added, at such a rate as to hold the temp at exactly 100° (a few cc at a time). After the addition is complete, the temp will have to be maintained at 100° with the heating device until the smell of nitrotoluene is gone. Vigorous stirring must be used through the entire operation. Set the reflux condenser to distill and lead steam directly into the vessel to steam distill the toluidine out of the reaction contents.

*Separation of the o- and p-Toluidines.* The oil from the distillation is separated from the water, ice and salt are added, and the mixture is stirred. A whitish-yellow crystalline compound appears, which is the hydrate of the p- compound. This is filtered off through an ice cooled filter funnel, and then is well pressed to remove any oily o- compound. The o- compound is separated from the filtrate with a separation funnel.

*Tyrosine.* 100 g of silk waste is boiled for 6 hours with 300 cc of fuming HCl acid under a reflux condenser. The greater part of the HCl acid is removed by evaporating the resulting brown solution under vacuum. The evaporated residue is dissolved in water, filtered, and made up to a known volume. The percentage of HCl acid is determined by titration of an aliquot part of the liquid and the amount of NaOH calculated for, the whole solution is then added, with ice (always use a little water in an ice bath) cooling, and constant stirring. A brownish-black compound will precipitate at once. After standing a while it is put into ice water and allowed to sit for an hour. It is then filtered off with vacuum suction, dissolved in hot water, and boiled vigorously with 9 g of decolorizing carbon. Filter off the carbon hot, and pure tyrosine will crystallize on cooling, to be removed by filtration. A second crop can be obtained by concentrating the mother liquor. Yield: 5-6 g of colorless crystals.

*Urea.* 50 g of potassium cyanide is heated in an iron crucible under a large flame until it begins to fuse. 140 g of red lead is added in small portions, while the mixture is stirred with a rod. When the addition is complete and the frothing has stopped, the fused mass is poured onto an iron tray. When cold, the mass is separated from metallic lead, ground up, and digested with 200 cc of cold water for 1 hour. The filtrate from this mixture is treated with 25 g of ammonium sulphate and evaporated to dryness on a water bath. The residue is powdered well, transferred to a flask and is boiled with 3 installments of ethanol under reflux, to dissolve the urea from the potassium sulphate. Each of the 3 ethanol extracts is filtered, then combined, and evaporated to a small bulk, until crystals of urea separate on cooling and standing. Mp: 132°.

*Phenyl Methyl Ketone (Acetophenone).* Place 100 cc of sodium dried benzene and 80 g of fresh aluminum chloride in a 500 cc three necked flask that is equipped with a stirring device, an addition funnel, and a reflux condenser that has a calcium chloride drying tube inserted in it. 25 g of acetic anhydride is added over 30 min from the dropping funnel with vigorous agitation. You should note evolution of hydrogen chloride. Boil the mixture under reflux for 30 min, continuing the stirring, then pour onto ice. The precipitated aluminum hydroxide is dissolved by

adding the minimum amount of coned HCl acid. Add ether, shake well, and separate the ether-benzene layer. Shake with NaOH solution, separate and dry over calcium chloride. Remove the solvents by evaporation and distill the acetophenone at 199-202°. Yield: 24 g of colorless plates with a sweet odor. *Note:* Aluminum chloride must be weighed in a dry, stoppered bottle.

*Phenylacetoneitrile.* This is the non-ring, substituted version of the phenylacetoneitrile that was given above. Used in conjunction with the LAH- $AlCl_3$  reduction (JACS, 77, 2544), given in the reductions chapter, it gives a non-ring substituted phenethylamine. 60 g of commercial potassium cyanide is dissolved in 55 g of water, in a 1 liter, round bottomed flask and placed in a fume cupboard, with a reflux condenser fitted to the flask. 100 g of benzyl chloride dissolved in 100 g of ethanol is poured slowly into the hot solution of potassium cyanide through the top of the condenser and this mixture is heated to a gentle boiling reflux, for 4 hours, on a sand bath. Cool, decant the dark brown solution of alcoholic phenylacetoneitrile from the crystalline deposit of potassium chloride, and distill over wire gauze in a fume cupboard, collecting the fraction at 210-235°. To purify; redistill and collect the fraction at 230-325°. Yield: about 70 g.

*3,5-Dimethoxyacetophenone.* This is used as starting material for many THC formulas. This compound is quite expensive and is one of the few things that may be cheaper to make yourself. The last time I priced it from Aldrich, it was costing \$75 for 5 g. If your formula calls for a large quantity, you will have to wait for them to make your order, as they do not usually stock more than 20 or 30 g. You may order from several different companies, if in a hurry, or you may synthesize as follows.

Buy 3,5-dimethoxybenzoic acid or make like this. 3,5-dihydroxybenzoic acid is mixed with 134 g of dimethylsulfate, 60 g of sodium hydroxide, 300 ml and 35 g more sodium hydroxide, then reflux. This 3,5-dimethoxybenzoic acid is converted to 3,5-dimethoxybenzoyl chloride by reacting with  $PCl_5$ , which is extracted with portions of ether and filter. Saturate the ether with ammonia, after cooling the ether to 0°, and filter. Wash the solids with cold ether, then water, and recrystallize from hot water to get 3,5-dimethoxybenzamide.

Buy 3,5-dimethoxybenzamide or prepare as above and add (110 g, powdered) it to a five fold excess of methylmagnesium iodide, and reflux for 16 hours. Decompose by adding the reaction product to 1,200 ml of coned HCl acid and an equal amount of ice. Allow this reaction to remain for 17 hours, with occasional shaking. Extract with ether, and distill after removal of the ether (this can be done by evaporating in vacuo), collecting the fraction boiling at 115-128° under 0.3 mm of vacuum to get 66 g. Store in refrigerator to solidify and wash with a little, low boiling petroleum ether to remove oily contaminant. Recrystallize from petroleum ether to get a little over 60 g of pure product (3,5-dimethoxyacetophenone). Mp: 43°.

*Acetonedicarboxylic Acid.* To 250 g of powdered citric acid add 500 g of 15% oleum. After the foaming has ceased (15 min), the mixture is heated on a steam bath under a good fume cupboard. The foaming (reoccurs upon steam heating) is controlled by shaking the flask. When the carbon monoxide stops generating, the flask is cooled in water, then ice, and then in a freezing mixture, despite the presence of starting material that has not reacted. Pour, with stirring, into a thick walled beaker, which is cooled externally onto 300 g of crushed ice. Let stand in the beaker, which is cooled externally with a freezing mixture, for 2 hours. Filter the resulting crystals and dry by evaporating on dry filter paper in vacuo. This 150 g of crude product can be used directly in some formulas, but not in others. To purify; extract in acetic ester to yield 100 g of pure acetonedicarboxylic acid.

*Ethylamine & Benzyamine.* May be used in place of diethylamine when that compound is unavailable, or primary amines of this type (methylamine, dipropylamine, etc.). An aqueous solution of 150 g of potassium dichromate is first reduced to chromic chloride with alcohol and HCl acid and further to chromous chloride by shaking with cleaned (see reductions chapter) powdered zinc. Chromous acetate is precipitated with a concentrated aqueous solution of sodium acetate, filtered, washed with water, and placed in a flask equipped with a stirrer and a reflux condenser. The reducing agent (I would use Raney Nickle) is covered with 500 cc of alcohol, 15 g of benzonitrile is added, and at boiling temp (while hydrogen is passed through), an aqueous solution of 80 g of KOH is added dropwise. The red chromous acetate changes to green chromic hydroxide. The mixture is acidified and distilled with steam (this removes the alcohol and unchanged benzonitrile). The residue is made strongly alkaline and again distilled with steam as long as any bases pass over. The distillate is made acidic with HCl acid and evaporated to dryness on a steam bath. The hydrochlorides are decomposed with strong KOH solution, the amines are extracted with ether, and the extract dried with KOH, and distilled. 4 g of dibenzylamine comes over at 65-66° with 10 mm of vacuo. Acetonitrile (33 g) when reduced using this procedure gives ethylamine.

*Formamide.* In a 3 liter flask, equipped with a reflux condenser pointing downward, and a gas inlet tube run down close to the bottom of the flask, is placed 1,500 cc of pure formic acid. This is saturated with dry ammonia while being cooled externally with cold running water. The lower end of the condenser is connected to a suction flask, through the side of the outlet of which the ammonia is removed. The ammonia is admitted at such a rate, that the formic acid is neutralized in about 20 min. Crystals of ammonium formate appear at the cold upper portion of the flask, while the main portion remains melted. The stream of ammonia is now reduced and the flask is heated on an oil bath. At 150° water starts to distill over (yes, that's ° centigrade). The temp is increased slowly to 180°, during 4-5 hours, until nothing more distills. If the reaction is heated too long, the reaction mixture turns from its natural brown color to a dark-brownish black. Cool the distillate in a stream of ammonia and distill in vacuo. Collect the fraction coming over at 105-106° at 11 mm of vacuo. The melting point is usually given as 2-4° C.

*Glyoxylic Acid Ester.* A solution of 232 g of diethyl tartrate in 1200 cc of dry benzene is cooled with ice and 500 g of lead tetra-acetate is added, with stirring, over 1 hour. The temp is held below 10°. Stir for 12 hours and filter off the precipitate with vacuum assist. Wash the filter cake with dry benzene and remove this benzene by distilling off with vacuum. After the first 500 cc have been distilled, the receiver is changed out and the distillate is tested for glyoxylic acid ester. For this purpose a portion of the new distillate is heated with an equal volume of 2 N ammonia. If glyoxylic acid is present, the yellow color will change to a blood red color. The solution is coned to a volume of 300 cc. This residue is mixed with 900 g of dry ethanol and this solution is fractionally distilled with vacuum. Collect the fraction boiling at 54-55° with 16 mm.

*Ethylamine, Diethylamine, Triethylamine.* These are important intermediates in the synthesis of DMT, LSD and several other abusable drugs. This is why they are sometimes difficult to obtain and watched closely by the DBA. Ethylamine and triethylamine are not as suspicious as diethylamine because they give weaker drugs than the latter. The synthesis to follow, will require the knowledge of glass tube sealing and the dangers of glass bombs. You may substitute a metal bomb, if it is lined with pyrex, glass or porcelain. I'm not sure if stainless steel will work here. If you use a large bomb, then it would be a good idea to scale up the amounts of all chemicals involved equimolarly. Making the scale too large will hurt the yield, so don't get carried away.

*The Chemicals.* Ethyl iodide can be purchased or made as described in the JCS, 117, 1592 (1920). Either way, it must be purified by fractionally distilling, collecting the fraction boiling at 71.9°-72°. Ammonia must be purchased dry and pure or purified and dried according to the method recommended by Johnson, J. Chem. Ed., 6,443 (1929), using an excess of sodium amide.

The reaction is carried out in a sealed pyrex tube or a suitable replacement. Calibrate and mark the tubes (do not scratch them, use a marker) to a total volume of 20 ml and dry them by heating in an oven at 110°, cool and keep them in an atmosphere of dry ammonia (the exclusion of water of all types cannot be overstressed in this reaction) until sealed. Into each tube put 7.5 g of the dry ethyl iodide and liquid ammonia is condensed to the 20 ml volume mark by using a dry ice acetone bath. The sealed tubes are then transferred to a 0° bath and allowed to stand at that temp for 30 min or until they reach that temp. Mix thoroughly by shaking vigorously for 1 minute. An exothermic reaction should begin (you will see the bomb contents boil under their own self generated heat) one min after the shaking. Get away from the bombs at this time (shut them in a strong cupboard) as bombs sometimes explode. *Note:* If you are using the glass or pyrex bomb method, then read a complete book on the subject, so you know the rules to the above and following procedures as they can be dangerous. To use high pressure hydrogenation equipment; see the reductions chapter in this book.

The bomb tubes are returned to the dry ice-acetone bath. After cooling thusly, the tubes are drawn out to a fine capillary to allow the ammonia to escape, and the entire reaction mixture is immediately collected in an excess of dilute HCl acid solution. Evaporate the acidic solution to dryness on a steam bath, desiccate the residue, and extract in a soxhlet extractor for 12 hours using chloroform as the solvent (dry chloroform) and taking care to exclude all H<sub>2</sub>O. Distill off the chloroform and if separation is not important to you, then you can use the combination of all three amines in a synthesis calling for any one of the three.

To separate: dissolve the above distillation residue in water. This aqueous solution is agitated in a separation funnel, with 35 ml of 12 M of NaOH solution and 6 ml of benzenesulfonyl chloride, to a total solution volume of 100 ml over a period of 10 min at 0°-5°. Extract 3 times with 50 ml portions of cold ether. Combine the ether extracts and extract them with three 25 ml portions of cold 1 M HCl acid solution. The NaOH, the ether, and the HCl acid solutions are treated separately as follows.

The ether extract contains benzenesulfonyl diethylamine, some dibenzenesulfonyl ethylamine and the excess of benzenesulfonyl chloride. Evaporate the ether, warm the residual oil for half an hour, with 10 ml of 6 M NaOH with enough ethanol to keep the oil in solution (dissolved). Cool with an ice and CaCl mixture, seed by rubbing or scratching a glass rod in the vessel, and with stirring, dilute slowly with 100 ml of NaCl solution (30 g of NaCl per liter). Allow to stand for 12-16 hours. Remove the benzenesulfonyl diethylamine by filtration and wash with cold, saturated (this is not the same as above) NaCl solution. Add the filtrate to the NaOH solution.

Dilute the NaOH solution to 500 ml and evaporate to dryness by heating the vessel with a gentle steam stream and a very low vacuum. The residual product is the ethylamine.

The HCl acid solution yielded triethylamine as a picrate when treated with picric acid as described throughout this book and many others.

## ***OVER THE COUNTER PRECURSORS***

Over the counter precursors are sometimes psychoactive and need no further treatment once extracted from the inert material. It would be impractical for me to give specific details on how to remove every drug or precursor from every different type of inert material that each different company is using. So, I will give you a few examples and explicit directions on how to use the *Merck Index* to get the physical properties of these substances and use this information to extract the goodies. Once you understand this procedure, you will be able to use it on any substances that you may run into.

Below is a list of what you can expect to find, in what type of medication that is obtainable over the counter.

### **Allergy, Decongestants, And Asthma Medication**

1. *Ephedrine*. Is a psychotomimetic (gives an amphetamine type high) in larger doses (25 to 100 mg). Can be reduced to memylamphetamine in one step (find a gentle reduction in the reductions chapter and apply it to an equimolar amount of ephedrine) which is psychotomimetic with a dose of about 5 mg.
2. *Pseudoephedrine*. Same as above, except that it is better suited to the reduction to methylamphetamine.
3. *Phenylephrine*. Is a psychotomimetic. Probably will give a more potent drug if reduced like ephidrine.
4. *Phenylpropanolamine*. Is a psychotomimetic in doses of 25 to 100 mg.
5. *Acetaminophen*. Is an analgesic (pain reliever) type drug that is active in doses of 300 to 600 mg.
6. *Cloropheniramine*. Is a psychotomimetic with good vasoconstrictor properties.
7. *Theophylline*. Is a smooth muscle relaxant, diuretic, and a myocardial stimulant (not psychoactive stimulant). It is undesirable because it may cause nausea and dizziness and should therefore be removed.
8. *Phenobarbital*. Is a sedative, hypnotic, and somewhat analgesic. It is addictive.
9. *Epinephrine*. Is adrenaline. This substance is highly psychotomimetic in small doses (1 to 5 mg), but is not orally active because enzymes in the stomach destroy its molecular structure. To keep from having to inject it, put a dose under your tongue and let it absorb into your blood stream in this manner.

### **Pain Relievers**

1. *Quinine sulfate*. Is an analgesic that is active at about 300 mg.
2. *Acetaminophen*. See above.

### **Motion Sickness Pills**

1. *Scopolamine*. Is a central nervous system depressant that can cause excitement, blurred vision, urinary retention, and severe hallucinations. The dose is around  $\frac{1}{h}$  to 1 mg and should be used with caution. Scopolamine has been used to treat Parkinson's disease with good success.



### Nose Spray Decongestants

1. *Phenylephrine*. See above.
2. *Oxymetazoline*. Is a sympathomimetic (this is much like psychotomimetic), orally active at 5 to 10 mg per kilogram of body weight.

### Cough Syrups

1. *Ephedrine*. See above.
2. *Acetaminophen*. See above.
3. *Dextromethorphan*. Is a relative of nalorphine. It is a narcotic antagonist, yet it has good analgesic effects. In doses of about 90 mg or more it is hallucinogenic. It is not addictive.
4. *Codeine*. Is a narcotic derived from morphine and is addictive. It can be purchased over the counter, but you will have to sign for it. Sometimes you will have to show identification. It creates feelings of euphoria and weightlessness with doses of about 50 to 150 mg. It can also be made much more potent by hydrogenating to dihydrocodeinone as instructed in the analgesic chapter in this book.

### Extracting Or Separating These Substances

A thorough knowledge of the physical properties of the compounds in the medication that you are dealing with must be known. The *Merck Index* will have these substances listed along with their mp, bp, and solubilities. The best way to show you how this separation is effected is to give you some examples.

Let's say that I just purchased 6 fl. oz. of average codeine cough syrup. I read the label and find that every fl. oz. contains:

Acetaminophen.....	1000 mg times 6 = 6000
Pseudoephedrine .....	60 mg times 6 = 360 mg
Codeine sulfate.....	30 mg times 6 = 180 mg
Dextromethorphan.....	30 mg times 6 = 180 mg

Obviously there is quite a bit of dope in these cough medications. Remember to multiply, the amount per dose times the total fluid oz. of the bottle, when figuring the total amount available. Now, I look up the properties of each and record each. Consider what form I'm dealing with; a liquid. How do we separate liquids? Column chromatography would work great. Read the section on column chromatography carefully. Then refer to the properties that you just recorded.

From what we see on the next page (properties) we can tell that codeine is not very soluble, so it stands to reason that this will be the last substance that will be eluted from the column. Acetaminophen looks the most soluble, so let's get rid of it first. Acetone looks like a good choice, but it's hard to tell because the *Merck Index* did not say if the other substances are soluble or insoluble in acetone. Try a little and see what types of crystals appear upon evaporating off the solvent, test the melting point and see if it is exactly as stated for acetaminophen. If there are only two types of crystals then it may be easier to go ahead and elute these and then separate

them from each other later. Also, if you get two or more compounds that give much of the same effect, then there is really no point in separating them (e.g. acetaminophen and codeine), unless you plan to modify one of the compounds, then it must be done.

	Soluble In Hot Water	Not Soluble In Cold Water
Acetaminophen	ethanol methanol acetone ethyl acetate	petroleum ether benzene pentane
Pseudoephedrine	water (cold & hot)	chloroform
Hydrochloride	ethanol methanol	
Codeine sulfate (note the substances which are incompatible with codeine)	30 ml of water per g 1 <sup>1</sup> / <sub>4</sub> L of ethanol per g	chloroform ether, ethyl
Dextromethorphan	chloroform	ether, ethyl
Hydrobromide	propylene glycol hot ethanol	

Next, we see that Dextromethorphan is soluble in chloroform and the remaining two substances are not. Add only enough chloroform to get the calculated amount of substance.

It takes a lot of ethanol to elute 1 g of codeine. A little ethanol elutes a lot of pseudoephedrine, so we use just enough cold ethanol to remove the pseudoephedrine (the colder the ethanol the better we keep the codeine from mixing in). If the ephedrine is to be reduced it must be purified completely.

If chromatography scares you, then the substances can be distilled out (sometimes, not always). If distilling, it is nice to know the boiling points, so you will have a good idea of when the substance is coming over. If you cannot find the bp then you will have to watch the temperature given on your thermometer very closely, when it changes, then the substance that is coming over is changing (see the distillation section of the equipment chapter). I prefer to distill off the inert crap and run the residue through the chromatography column, or visa versa. Always use a high vacuo during the distillation and never over-heat (when things stop coming over, stop the heat). Many of the substances are decomposed by too much heat. A vacuum helps, but you should look at the melting points and boiling points to keep from ruining the product.

Let's try separating some solid form of OTC (over the counter) drugs. The most common is the decongestant, allergy, cold relief tablets. Rule #1 is try to find the tablets that do not have coloring to them, the plain white pressed tabs such as Tedral are perfect.

For an example Tedral contains:

1. *Theophylline*. 130 mg per tablet, it is useless for a recreational drug so it must go. *Note:* Always record mp and other properties.

Soluble In	Not Soluble In
120 ml H <sub>2</sub> O dissolves 1 g	ether, ethyl
80 ml ethanol dissolves 1 g	
110 ml chloroform dissolves 1 g	

2. *Phenobarbital*. This is put into Tedral to counteract the sympathomimetic effects of the ephedrine. it is a good sedative once separated from the ephedrine.

Soluble In	Not Soluble In
1 g dissolves in 1 L of water	none listed
1 g dissolves in 700 ml benzene	
1 g dissolves in 40 ml chloroform	
1 g dissolves in 1 L ether	

3. *Ephedrine*. There are different types of ephedrine, so it may be necessary to experiment and find the one you are trying to extract, but they are generally the same, so most solvents may be good enough to get some product to test.

Soluble In	Not Soluble In
1 g dissolves in 4 ml water	ether, ethyl
1 g dissolves in 40 ml ethanol	

All three of the substances above are soluble in chloroform (chloroform evaporates fast, too), so to begin with I would dissolve the tablets by refluxing in chloroform for 10 minutes. Filter off the inert matter from all three of the substances by utilizing hot filtration. Now run the residue through the chromatography column after evaporating off the chloroform. The column is the most efficient method, but it is not completely necessary. Let's say that we are not using the column.

Ephedrine is very soluble in water, so using cold water (almost freezing) we will remove the ephedrine (remember that 4 ml dissolves 1 g of ephedrine so use a very small excess of water).

To get rid of the theophylline from the useful phenobarbital; dissolve the phenobarbital with ether. This will take a large amount of ether, but do not use too much. Heating slightly may reduce the amount of ether. Also, cheaper and less suspicious solvents may replace the ether, only experimentation will tell.

I will now go into the extraction of adrenalin. I felt this necessary as it can be extracted from certain glands of most mammals. This drug should be legal most everywhere and can be synthesized. Also, see Ber, 37, 4149 (1904) or British pat. 816, 857 (1959).

The adrenal medulla secretes only one hormone and that is epinephrine (adrenalin). This is probably why the fresh gland contains such a surprisingly high concentration of the hormone (0.2%). To retrieve the adrenalin; acquire both the medulla and cortex glands. Most any butcher will go through the trouble of removing these for a small fee, if you can get someone at a large slaughter house to do this for you, then the reward will be a very large quantity of adrenalin.

Finely chop the glands with a razor blade or pulverize in a blender. Extract the adrenalin into a small excess of hot H<sub>2</sub>O concentrate in a vacuum. Remove the salts and proteins (if proteins are not removed, they will give the same effect as blood poisoning from a rattle snake bite, but worse) by precipitating with alcohol and remove this precipitate by filtration. The filtrate is then distilled in vacuo to remove the adrenalin (I would perform the filtration above, at room temp). Add a little ammonia to precipitate the active compound and filter from the water. The amount of ammonia depends on the amount of substance. To experiment, to get the proper amount, add a very little amount of ammonia to the distillate and filter off any precipitate if any forms. Add a little more ammonia and filter. Repeat until no more precipitate is formed, remember the amount of ammonia used and use this amount on the same amount of filtrate during the extraction of the next batch.

The combined precipitate must be purified by dissolving in acid (hydrochloric or sulfuric will do), precipitate the impurities by adding alcohol and filter them off. Distill off the alcohol and precipitate the adrenalin by adding ammonia as before. This process is repeated until the 211-212° mp is achieved, and the product is a clear crystalline, free of ash.

Adrenalin is rapidly destroyed by the enzyme amino-oxidase and is therefore ineffective orally. It may be injected, snorted or possibly dissolved under the tongue. It is of considerable value to restore heart beat after sudden heart failure. This is due to its powerful stimulating effect.

This is enough to give you the general procedures to extract any of the over the counter drugs that you may run into. If you are still hopelessly confused, then you really are not educated enough in the chemistry field to be working in a laboratory.

*Note:* Synthetic adrenalin can be emptied into a vessel, from those Primatine Mist type inhalers that asthma attacks are treated with, and extracted and precipitated (water and ammonia respectively) as described above.

## THE WORK AREA

This two sink bench can be made cheaper than you might think. By using PVC piping and PVC valves and buying old used sinks, you can afford to have two or three.

Your lab should not look this cluttered. I am including this particular work bench to show all the different items and their uses. If you cannot afford all these things, keep with the more simple formulas. I have noted the mandatory things and even simple operations should not be performed without them.

Notice how the flame operations (generating steam, superheating steam, etc.) are secluded from the flammable vapor reaction part of the work bench. Both of these sections should be made vapor-proof with a generous quantity of silicon sealer (bathtub caulking is OK also). Put your sealer on all mating surfaces and cracks, inside and out.

The frame for such a work bench, or vapor boxes, can be made from 2" by 2" or 2" by 4" studs and *W* or  $\frac{5}{8}$ " plywood. Next, you will need to line the inside of these boxes with sheetrock, which is cheap and easy to cut (use a razor knife). As shown, plexiglass ( $\frac{1}{4}$ " or  $\frac{1}{2}$ " inch) covers should be employed. This enables you to watch your reaction without endangering you in case of explosion. It also keeps fire or flaming liquids contained, hence easier to put out. If you are a hopeless penny-pincher and will not spend a few extra dollars for plexiglass, then you *must* use a plywood door to cover your flame, steam generating, and vapor-proof boxes. Make a good sealing surface with door jam insulation and latch with a good bolt.

The exhaust fan and vacuum can be piped into your sewer main, but valves must be employed to keep this pressure from overcoming your water traps and blowing back into your house through the sink and bathtub drains. Most fans may not be capable of producing this much pressure, therefore you must try to use the valves if necessary.

The exhaust fan in your reaction box or fumehood *must* be a sparkless motor. On most all formulas, fume evacuation is a must!

If using high pressure equipment, make your reaction box and door out of *W* steel plate. This can and should be welded air tight.

Diagrams follow after the workbench index.

## **WORKBENCH INDEX**

- A. *Butane or Propane Valve Assembly.* Use only the best equipment. Teflon tape all threads before assembly.
- B. *Bunsen Burners.* Always check for leaks.
- C. *Steam Generator.* When using electricity try to find a high wattage 220 volt heating element. Use good metal tubing and threaded couplers.
- D. *Steam Superheater.* (See equipment chapter).
- E. *Clamps.* For holding glassware and apparatus.
- F. *Thermometers.* Solder a collar to hold these into place. They are necessary to indicate temp of superheated steam.
- G. *Insulation.* Steam lines should be insulated whenever they get near wood, plastic, etc.
- H. *Cold Water Inlet*
- I. *Vacuum Aspirator.* Can be water, steam or mechanical powered. You can make one out of an old air conditioning pump (like on a car engine).
- J. *Vacuum Line.* Coil up, out of way, when not in use.
- K. *Plug.* Cut holes to fit discharge lines.
- L. *Hot Water Inlet.*
- M. *Electric Fry Pan or Heating Mantle.* When using fry pan, always seal off electric connections and controls from vapors with silicon.
- N. *Fume Evacuation Fan.* Use sparkless motor, only.
- O. *Sinks.* Buy used at your local plumber's.
- P. *Steam Powered Heating Mantle.* (See elsewhere.)
- Q. *Hinges for Doors.* Mount on side or top.
- R. *Ringstands.* Can be made by welding a rod onto a flat, heavy piece of metal.
- S. *Steam Hoses.* For cleaning, minor heating, etc.
- T. *"T's".*
- U. *Propane or Butane Tank.* Always check for leaks. 5 gal is plenty big enough.
- V. *Regulator.* For accurate gas pressures.
- W. *Water Hose.* For cooling condensers, rinsing, etc.
- X. *Handles.* To lift doors.
- Y. *Latches.* To hold doors shut.
- Z. *Plexiglass Doors.* Can also be made of wood. Mount securely.
- AL *Silicon.* For vapor-proofing.

*Note:* Fresh air inlet holes are to be open when using vapor evacuation fan. Close them (or plug) when the fan is off. Have several of those automotive fire extinguishers handy.

Steam powered heating mantle. Make hole perfectly round and as big as possible, without having flask falling into mantle.

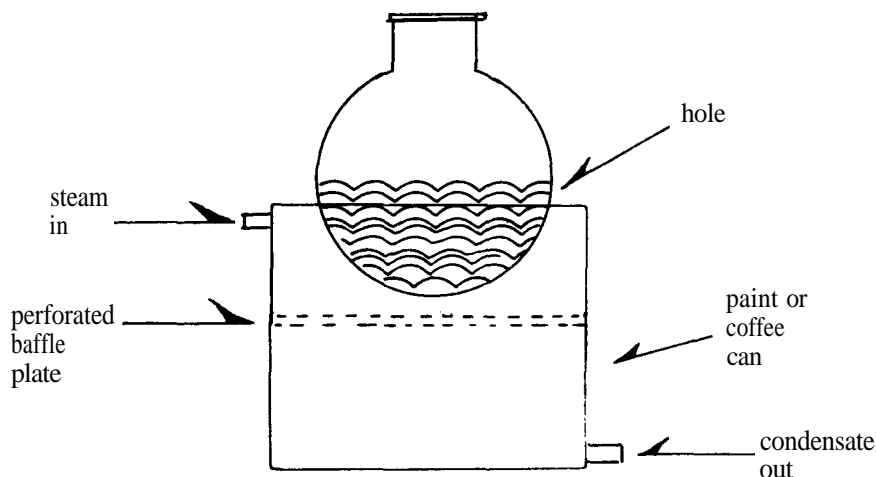

This is the best way to discard water or mechanical powered vacuum (generated) waste.

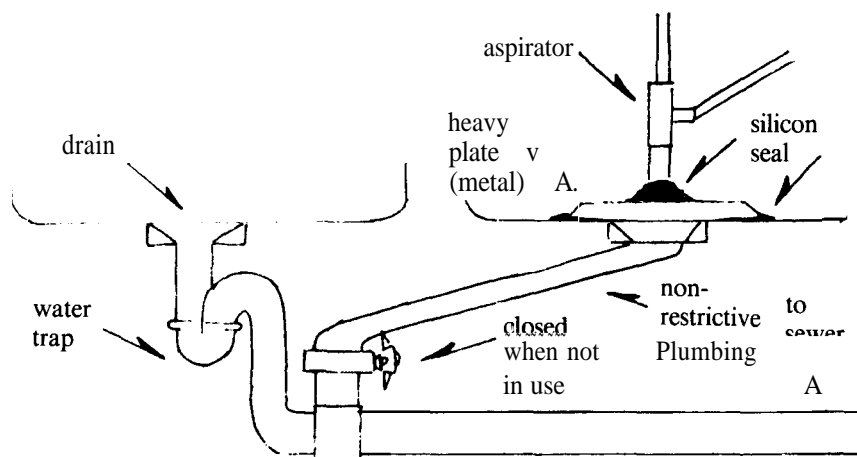

Steam or water powered aspirators make good vacuum sources and can be used to divert bad smells down the sewer (see above). They can be made as shown to the right. If the inlet pressure is high and the size is large enough, this can make a great fume cupboard evacuator.

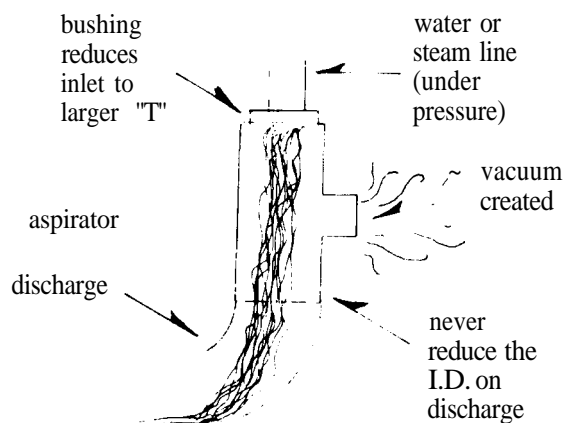

Below are two types of steam generators that you can build. The top one utilizes gas and the bottom one uses electricity for power. Every work bench needs steam. It is very safe for heating and very effective for cleaning glassware, etc.

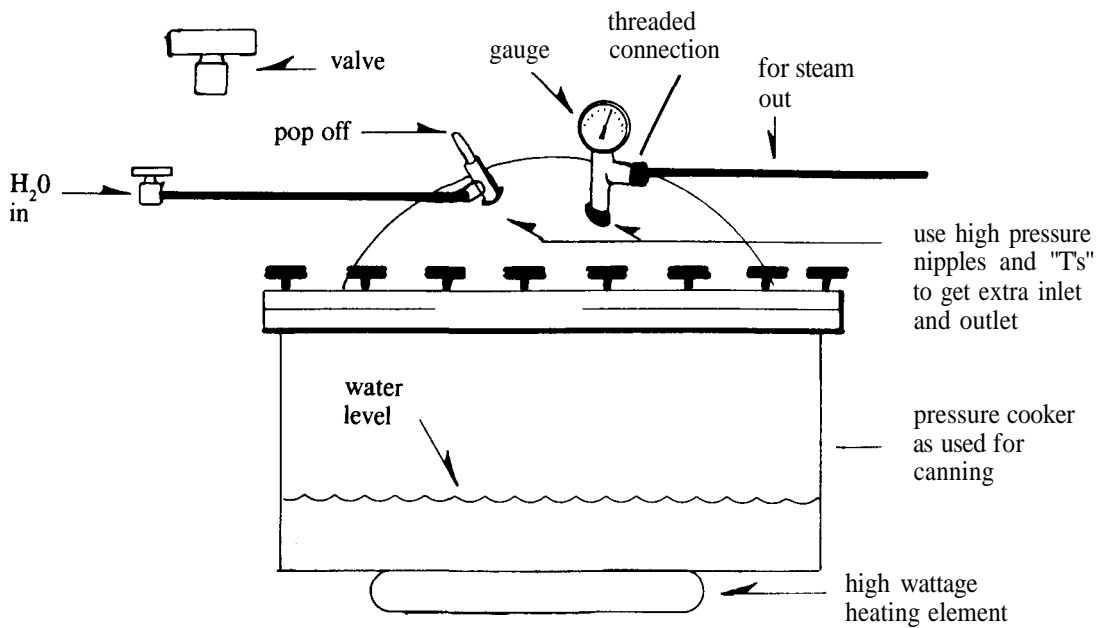
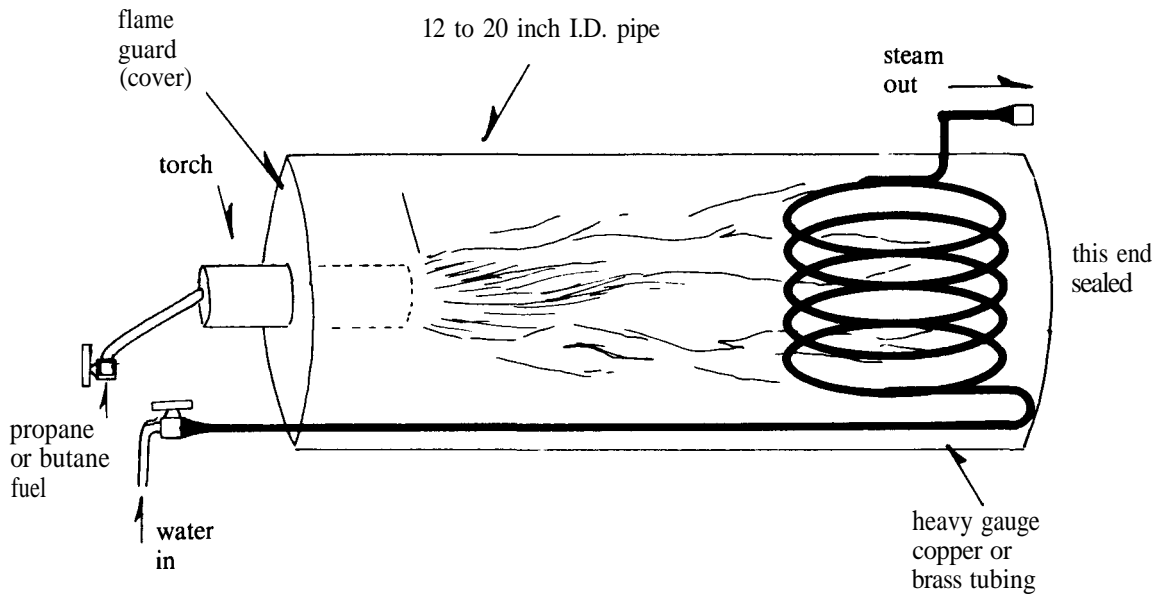



# WORKBENCH

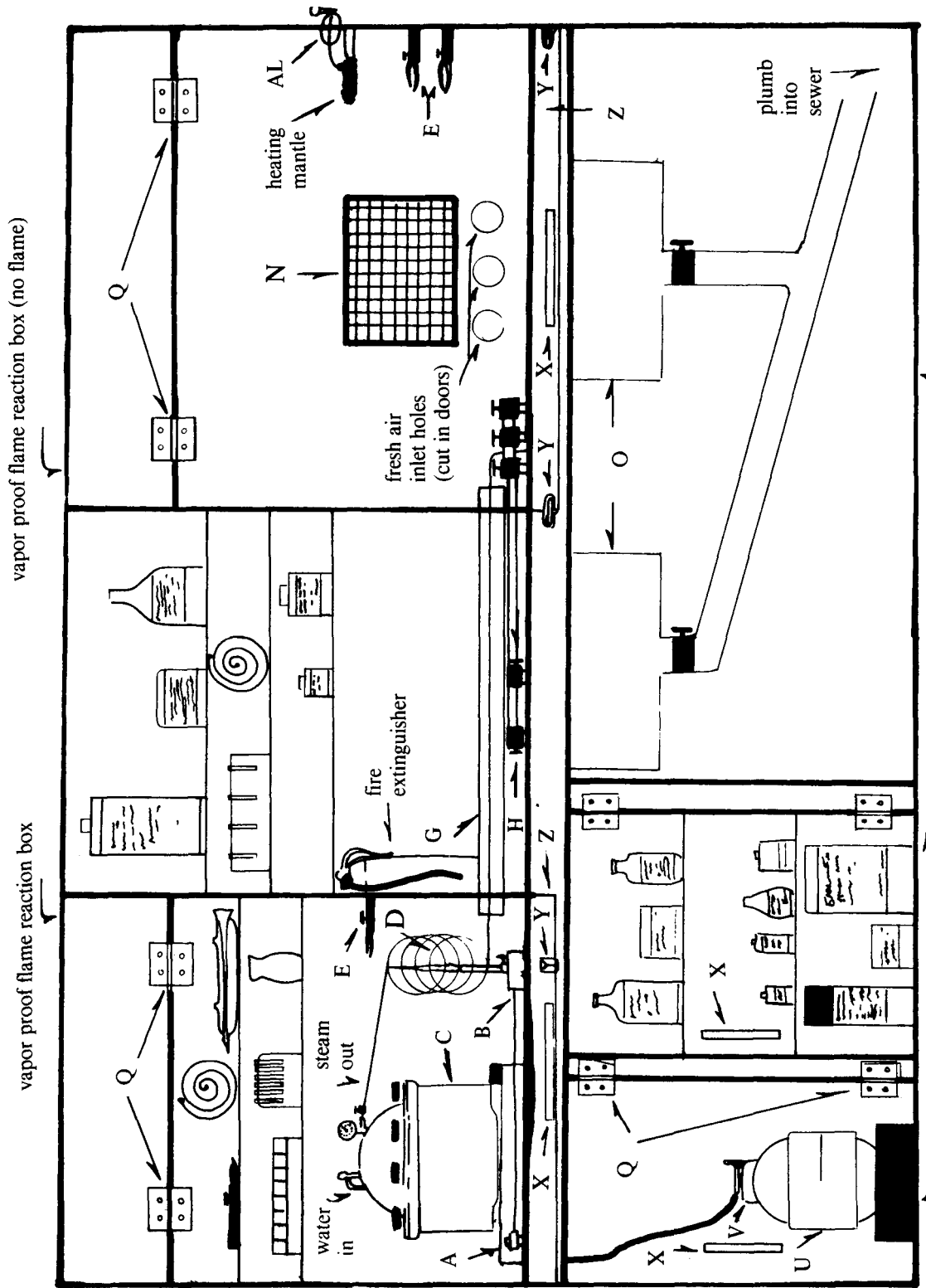

### WORKSHOP FROM TOP VIEW

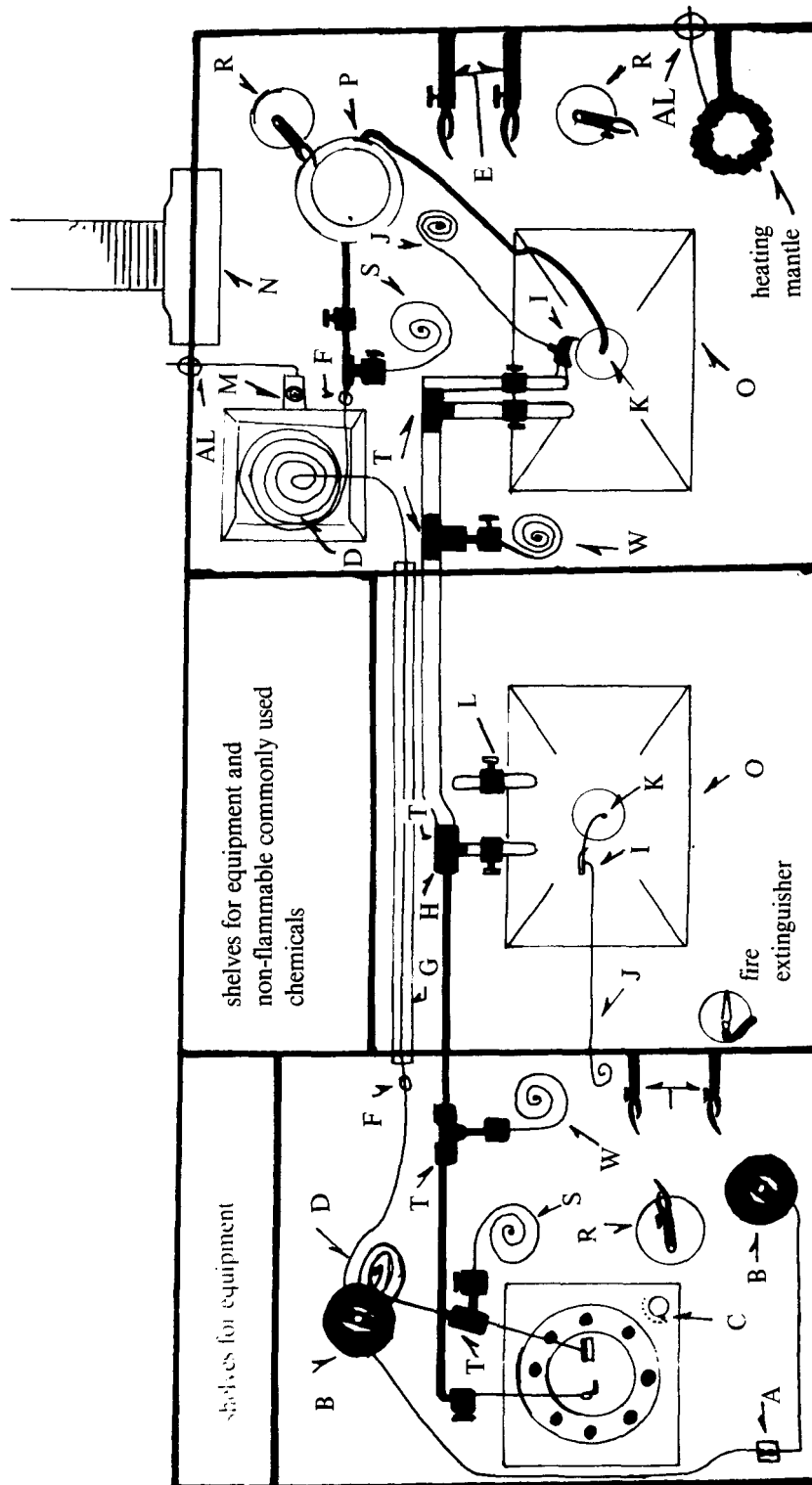

## ADDITIONAL INFORMATION SOURCES

These books are very useful when researching or working in any laboratory. They are expensive to purchase, but the information that they contain makes them priceless. Most all of these books can be found at any university library.

*PERRY'S CHEMICAL ENGINEER'S HANDBOOK* by Perry and Green

*THEO.P.D. CHEMICAL BUYERS DIRECTORY*

*CHEMICAL SOURCES U.S.A.*

Any chemical techniques handbook

*THE C.R.C. HANDBOOK OF CHEMISTRY AND PHYSICS*

*THE C.R.C. HANDBOOK OF LABORATORY SAFETY*

*LANGE'S HANDBOOK OF CHEMISTRY*

*HOW TO FIND CHEMICAL INFORMATION* by Maizel

*ENCYCLOPEDIA OF CHEMISTRY* by Van Nostrand Reinhold

*THE MERCK INDEX*

*ELSEVIER'S ENCYCLOPEDIA OF ORGANIC CHEMISTRY*

*THE CHEMIST'S COMPANION* by Gordon and Ford

Any chemical dictionary

Any nurses guide to drug effects and contradictions (Read this before beginning any operations, so that you know the dangers of the drugs that you are planning to produce.)

# ABBREVIATIONS

A	Angstrom unit (s)	Cu m	cubic meter
abs	absolute	d	density
Ac	acetyl	dec or decomp	decompose
ace	according	delta or (A)	double bond
addn	addition	dil	dilute
ale or alcoh	alcohol (ic) ethanol	dild	diluted
alk	alkaline	dl or DL	racemic
Am	amyl	e.g.	for example
ammon	ammonia	equiv	equivalent
amorph	amorphous	esp	especially
amt	amount	Et	ethyl
anhydr	anhydrous	Et <sub>2</sub> O	ether, ethyl
aq	aqueous	ext	extract
A.R.	analytical reagent	extd	extracted
atm or atmos	atmosphere	F	Fahrenheit degrees
B	base	ff	following
bp	boiling point	fp	freezing point
Btu	British thermal units	g or gms	grams
C	degrees Centigrade	gal	gallons
c	concentration by volume	g/l	grams per liter
cc	cubic centimeters	hr	hour
compd	compound	ibid	at the same place
cone or coned	concentrated	i.e.	that is
contg	containing	kg	kilogram
C.P.	chemically pure	l	liter
cpd	compound	Ib	pound
cryst	crystalline	L.D.	lethal dose
crystn	crystallization	M	molar

m .....	meter	R .....	alkyl
meg .....	microgram	sapon or saponif.....	saponification
mfr or mfg .....	manufacturing	satd .....	saturated
mg .....	milligram	soln .....	solution
min .....	can be either minute or minimum	subl.....	sublimes
ml .....	milliliter	temp .....	temperataure
mm .....	millimeter	uncor.....	uncorrected
mol wt .....	molecular weight	vol.....	volume
mp .....	melting point	v/v .....	percentage expressed in volume to volume, (the number of ml of constituent in in 100 ml of solution)
n or N .....	normal	wt .....	weight
no .....	number	w/v .....	percentage expressed in weight to volume, (the number of grams of constituent in 100 grams of solution)
o .....	ortho	w/w .....	percentage expressed in weight to weight, (the number of grams of constituent in 100 grams of solution)
oz .....	ounce	> .....	greater than
P or p .....	concentration by weight	^ .....	not greater than
p .....	para	< .....	less than
pat .....	patent	.....	not less than
pH .....	acid-base scale		
ppm .....	parts per million		
ppt .....	precipitate		
prepn .....	preparation		
press .....	pressure		
psi .....	pounds per square inch		
pt .....	point		

For journal abbreviations see your local librarian.

## CHEMICAL SOURCES NATIONWIDE

Here is a list of chemical suppliers that are legitimate businesses. It is true that the DEA often sets up fake supply houses, giving great prices on hard to find items, such as lysergic acid, to lure underground chemists into traps. These suppliers listed below are not part of any law organization. They are major suppliers only. However, they are required by law to report sales of certain substances. *Note:* 800 telephone numbers are toll free.

Make certain that you look in *Chemical Sources USA* to see who makes what you might need. *Chemical Sources USA* also tells you which of these suppliers is the bulk producer. This handy book can be found in any science library (see also the *Chemical Buyers Directory*).

Biochemical Lab, Inc  
14422 S San Pedro St  
Gardena, CA 90248

Chemical Dynamics  
PO Box 395  
Hadley Rd  
South Plainfield, NJ  
07080  
(201-753-5000)

Sigma  
PO Box 14508  
St. Louis, MO 63178  
(800-325-8770)

Kodak Laboratory  
Rochester, NY 14650  
(800-225-5352)

Lancaster Synthesis  
PO Box 1000  
Industrial Dr  
Windham, NJ 03087  
(800-238-2324)

United States Bio-  
Chemical Corp  
PO Box 22400  
Cleveland, OH 44122  
(800-321-9322)

Chemisphere Corp  
PO Box 250  
Boonton, NJ 07005

All World Scientific  
& Chemical  
3259 20th Av W  
Seattle, WA 98199  
(206-282-2133)

Reliable Chemical Co  
1161 Research Blvd  
St. Louis, MO 63132  
(314-997-7200)

Genzyme  
75 Kneeland St  
Boston, MA 02111  
(800-332-1042)

Merck & Co  
Isotope Division  
4545 Oleatha Av  
St. Louis, MO 63116  
(314-353-7000)

Polysciences  
400 Valley Rd  
Warrington, PA  
18976  
(800-523-2575)

K & K Laboratories  
121 Express St  
Plainview, NY 11803  
(516-433-6262)

## ***CHEMICAL SOURCES LOCALLY***

Look in the yellow pages of your local telephone book to find a chemical supplier. This is the type of business that the DEA will use for undercover purposes.

# GLOSSARY

- ABSOLUTE ZERO.* The melting point of helium (-272°C).
- ACETALDEHYDE.* Colorless flammable liquid used as a drug intermediate.
- ACETIC ACID.* Clear flammable liquid used mainly as a solvent.
- ACETIC ACID, GLACIAL.* Pure (99.8%) acetic acid.
- ACETONE.* Clear, flammable liquid used as a solvent.
- ACETYLENE.* Colorless gas with ether odor.
- ACIDS.* Acids are sour, turn blue litmus red and release H<sub>2</sub> when reacted with metals above H on the electromotive scale. The strength of acid depends on the number of free hydronium ions in the solution.
- ACIDS, OXIDIZING.* Nitric and coned Sulfuric acids are oxidizing acids.
- ALKALI.* A substance, which in water is bitter, slippery, caustic to the skin, and basic to litmus and other indicators.
- ALKALOIDS.* A group of basic nitrogenous organic compounds, which exhibit a powerful toxic action on the mammal system.
- ALKANE.* Term for saturated aliphatic hydrocarbon (paraffin hydrocarbon).
- ALLOY.* A liquid or solid mixture of two or more metals.
- AMALGAM.* Any alloy of mercury with one or more other metals.
- AMINE.* A class of organic compounds of nitrogen that can be in liquid, gas or solid. Derived from the process of amination.
- ANHYDROUS.* To be free of water, dry.
- AQUEOUS.* To contain water.
- AROMATIC NUCLEUS.* Six-carbon ring characteristic of all benzene and related compounds.
- ATMOSPHERE.* 14.69 psi or 760 mm of mercury.
- BASE, BASIC.* See alkaline (alkaly).
- BENZALDEHYDE.* Colorless or yellowish oil, very fragrant. Used in organic synthesis.
- CARBON.* The main constituent of all organic compounds.
- CARBON, DECOLORIZING.* (Activated carbon, bone black.) Forms of carbon having large surface area so that it has capacity to remove colors and impurities from air, gas, or solution.
- CATALYST.* A substance whose presence begins or increases the rate of a chemical reaction.



*CHARGED.* Add rapidly to, to fill.

*CHLORAL HYDRATE.* (*Knockout drops.*) Transparent crystals with aromatic, acrid odor, poisonous, used as medicine.

*DECARBOXYLATE.* To remove a carboxyl group from a molecule.

*DEHYDRITE.* Anhydrous granular, magnesium perchlorate.

*DENATURANT.* Additives to make certain compounds unsuitable for human consumption and abuse.

*DEOXIDIZER.* An agent which removes oxygen.

*DRIERITE.* Anhydrous calcium sulfate with a high affinity for water.

*EMULSION.* A permanent mixture of two or more liquids, which do not dissolve in each other, but which are held in suspension, one in the other.

*EXOTHERMIC.* A reaction or process which is accompanied by the evolution of heat.

*FEHLING'S SOLUTION.* Test reagent consisting of two solutions, one of copper sulfate, the other of alkaline tartrate, which are mixed just before use.

*FLUOROCARBONS.* Compounds of carbon and fluorine-analogs of hydrocarbons in which the hydrogen has been replaced by fluorine.

*FORMALDEHYDE.* Colorless gas, pungent odor, poisonous, used in organic synthesis.

*FORMIC ACID.* Colorless, fuming liquid, pungent odor, caustic, and vapors may be explosive.

*FURAN.* (furfuran, tetrol.) A heterocyclic ring compound.

*GRIGNARD REAGENT.* Reagents made by union of metallic magnesium with an organic chloride, bromide, or iodide, in the presence of a solvent with the complete absence of water.

*HEXANE.* Colorless, volatile liquid used as solvent, flammable.

*HEXYL BROMIDE.* Intermediate, for introduction of hexyl group.

*HYDRATE.* A compound formed by the combination of water with another substance.

*HYDRATION.* The absorption or combination of water with another substance.

*HYDRAZINE.* Colorless, fuming, corrosive liquid, vapors can be explosive, used in rocket fuels, explosives, etc.

*HYDRIODIC.* Clear, or pale yellow liquid, which is an aqueous solution of hydrogen iodide. Hydriodic acid is strong, and an active reducing agent, highly corrosive.

*HYDROGENATION.* Adding the hydrogen element to a molecule usually influenced by temperature, pressure, and catalysts. Can be a form of reducing as the H sometimes bumps off other elements.

*HYDROLYSIS.* A reaction in which water acts upon another substance to form an entirely new substance.

*ION.* An atom or molecule that has lost or gained, one or more electrons, making it electrically charged, positive or negative.

*ISOMERS.* Molecules which contain the same number and kind of atoms, but which differ in structure.

**KETONE.** A class of organic compounds in which the carbonyl group is attached to two carbon atoms.

**LACTIC ACID.** Colorless, syrupy liquid used in pharmaceuticals.

**MOLAR.** A molar solution is one that contains one molecular weight in grams (one mole) of its dissolved substance in one liter of solution.

**MOLE.** The amount of substance containing the same number of atoms, molecules, etc., as there are in twelve grams of pure carbon.

**MOLECULAR WEIGHT, (atomic weight.)** The weight in grams of an element, which equals one mole of atoms.

**N(normal).** The abbreviation and term used to describe a solution containing a gram equivalent weight of reactive material per liter of solution.

**NORIT.** Activated absorption carbons.

**OLEFINS.** Unsaturated aliphatic hydrocarbons with great chemical activity.

**OXIDASE.** An oxidizing enzyme.

**OXIDATION.** Any chemical change in which the oxidation state is increased.

**pH.** A means of expressing the degree of acidity or basicity of a solution.

**PRECIPITATE.** The formation of solid particles in solution.

**PYRIDINE.** An important organic base.

**PYROPHORIC.** Spontaneously combustible upon exposure to air.

**PYRROLE.** Yellowish-brown oil, smells like chloroform, used to manufacture drugs.

**PYRROLIDINE.** Colorless or pale yellow liquid, amine-like odor, poisonous, intermediate for pharmaceuticals.

**QUININE.** An important natural alkaloid, used to make medicines.

**RADICAL.** A group of atoms in a molecule, which remain unchanged through many chemical reactions.

**SOLFONATION.** The formation of a sulfonic acid.

**SPECIFIC GRAVITY.** The weight of a particular volume of any substance, compared with the weight of an equal volume of water, at the same temperature.

**STANNOUS CHLORIDE.** White crystalline mass used as a reducing agent and intermediate.

**SUSPENSION.** A liquid medium having small, solid particles uniformly dispersed through it.

**TITRATION.** A method of determining volumetrically the concentration of a substance in solution by adding a standard solution of known volume and strength until a change in an indicator is noted or by electrical measurements.

**TOLUENE.** Flammable liquid, solvent.

**VACUO.** To be in a state of vacuum.

**WHITING.** (Paris white.) Finely ground, naturally occurring calcium carbonate.

**XYLENE.** Flammable solvent.

Obviously I cannot define every chemical, term, or reaction that you will run into in an organic laboratory. If you do not see what you need here, look in any chemical dictionary. The *Merck Index* also lists many chemical properties and uses.

# MISCELLANEOUS TABLES

## *UNDERSTANDING THE PERIODIC TABLE*

- A. *PERIODS*: The 7 horizontal rows, called periods, contain the elements with increasing atomic numbers. Period 1 has the elements with one shell. Period 2 has the elements with two shells. Period 3 has the elements with three shells, etc. The first period contains 2 elements; the second and third, eight elements; the fourth and fifth, eighteen elements. In a period, the atomic radius generally decreases from Group I to Group VII.
- B. *GROUPS OR FAMILIES*: By this arrangement, the vertical lines of elements are called groups. Since the chemical properties of elements usually involve the outer shell of electrons (valence shell electrons), these Groups are called families because all the elements of group IA have one valence electron, all the elements of Group IIA have two valence electrons, etc. The IB-VIII Groups are called transition elements because they have unfilled inner shells and act somewhat differently from the A Groups.

Group O has 8 electrons on the outer shell (maximum) and are inert or inactive. They do not combine or form compounds. ( $\text{XeF}_4$  has been prepared lately, experimentally.) Note that in each group as the atomic number increases (going down), the atomic radius increases, and the atom gets bigger. Note that in each period as the atomic number increases (going right), the atomic radius generally decreases, and the atoms get smaller. All the elements, except those in the upper right-hand corner of the Periodic Table, are metals.

# PERIODIC TABLE

Mass numbers of the most stable or most abundant isotopes are shown in parentheses. Atomic weights are given to four significant figures.

Transition metals																		Mostly nonmetals (except H, He)																																																																																																																																																																																																																																																																																																																																																																																																																																																																																																																																																																																																																																																																																																																																																																													
Reactive metals																		METALS										NONMETALS																																																																																																																																																																																																																																																																																																																																																																																																																																																																																																																																																																																																																																																																																																																																																																			
IA																		IIA										IIIA										IVA										VA										VIA										VIIA										0																																																																																																																																																																																																																																																																																																																																																																																																																																																																																																																																																																																																																																																																																																																	
1																		2										3										4										5										6										7										8										9										10										11										12										13										14										15										16										17										18																																																																																																																																																																																																																																																																																																																																																																																																																																																																																																																																																																																																													
H 1.008																		He 4.003										Li 6.939										Be 9.012										B 10.81										C 12.01										N 14.01										O 16.00										F 18.99										Ne 20.18										Na 22.99										Mg 24.31										Al 26.98										Si 28.09										P 30.97										S 32.06										Cl 35.45										Ar 39.95										K 39.10										Ca 40.08										Sc 44.96										Ti 47.88										V 50.94										Cr 52.00										Mn 54.94										Fe 55.85										Co 58.93										Ni 58.71										Cu 63.55										Zn 65.37										Ga 69.72										Ge 72.64										As 74.92										Se 78.96										Br 79.90										Kr 83.80										Rb 85.47										Sr 87.62										Y 88.91										Zr 91.22										Nb 92.91										Mo 95.94										Tc 98.91										Ru 101.1										Rh 102.9										Pd 106.4										Ag 107.9										Cd 112.4										In 114.8										Sn 118.7										Sb 121.8										Te 127.6										I 126.9										Xe 131.3										Cs 132.9										Ba 137.3										La 138.9										Hf 178.5										Ta 180.9										W 183.9										Re 186.2										Os 190.2										Ir 192.2										Pt 195.1										Au 197.0										Hg 200.6										Tl 204.4										Pb 207.2										Bi 209.0										Po 210.0										At 210.0										Rn 222.0										Fr 223.0										Ra 226.0										Ac 227.0										Ku 260.0									
1																		2										3										4										5										6										7										8										9										10										11										12										13										14										15										16										17										18										19										20										21										22										23										24										25										26										27										28										29										30										31										32										33										34										35										36										37										38										39										40										41										42										43										44										45										46										47										48										49										50										51										52										53										54										55										56										57										58										59										60										61										62										63										64										65										66										67										68										69										70										71																																																											
1																		2										3										4										5										6										7										8										9										10										11										12										13										14										15										16										17										18										19										20										21										22										23										24										25										26										27										28										29										30										31										32										33										34										35										36										37										38										39										40										41										42										43										44										45										46										47										48										49										50										51										52										53										54										55										56										57										58										59										60										61										62										63										64										65										66										67										68										69										70										71																																																											
1																		2										3										4										5										6										7										8										9										10										11										12										13										14										15										16										17										18										19										20										21										22										23										24										25										26										27										28										29										30										31										32										33										34										35										36										37										38										39										40										41										42										43										44										45										46										47										48										49										50										51										52										53										54										55										56										57										58										59										60										61										62										63										64										65										66										67										68										69										70										71																																																											
1																		2										3										4										5										6										7										8										9										10										11										12										13										14										15										16										17										18										19										20										21										22										23										24										25										26										27										28										29										30										31										32										33										34										35										36										37										38										39										40										41										42										43										44										45										46										47										48										49										50										51										52										53										54										55										56										57										58										59										60										61										62										63										64										65										66										67										68										69										70										71																																																											

**Key:**

IA — Group  
 I — Atomic number  
**H** — Symbol  
 1.008 — Atomic weight

Period

Transition metals

Inner transition metals

METALS

NONMETALS

Lanthanum series

Actinium series

## INTERNATIONAL ATOMIC WEIGHTS

Parentetical weights refer to radioactive elements; the mass number, not the atomic weight, of the isotope with the longest half-life is given.

Name	Symbol	Atomic Number	Atomic Weight	Name	Symbol	Atomic number	Atomic weight
Actinium	Ac	89	(227)	Mendelevium	Md	101	(256)
Aluminum	Al	13	26.9815	Mercury	Hg	80	200.6
Americium	Am	95	(243)	Molybdenum	Mo	42	95.94
Antimony	Sb	51	121.75	Neodymium	Nd	60	144.24
Argon	Ar	18	39.948	Neon	Ne	10	20.179
Arsenic	As	33	74.9216	Neptunium	Np	93	(237)
Astatine	At	85	(210)	Nickel	Ni	28	58.71
Barium	Ba	56	137.34	Niobium	Nb	41	92.906
Berkelium	Bk	97	(247)	Nitrogen	N	7	14.0067
Beryllium	Be	4	9.0122	Nobelium	No	102	(256)
Bismuth	Bi	83	208.98	Osmium	Os	76	190.2
Boron	B	5	10.811 <sup>a</sup>	Oxygen	O	8	15.9994 <sup>3</sup>
Bromine	Br	35	79.904	Palladium	Pd	46	106.4
Cadmium	Cd	48	112.40	Phosphorus	P	15	30.9738
Calcium	Ca	20	40.08	Platinum	Pt	78	195.09
Californium	Cf	98	(249)	Plutonium	Pu	94	(242)
Carbon	C	6	12.01115 <sup>3</sup>	Polonium	Po	84	(210)
Cerium	Ce	58	140.12	Potassium	K	19	39.102
Cesium	Cs	55	132.905	Praseodymium	Pr	59	140.907
Chlorine	Cl	17	35.453	Promethium	Pm	61	(145)
Chromium	Cr	24	51.996	Protactinium	Pa	91	(231)
Cobalt	Co	27	58.9332	Radium	Ra	88	(226)
Copper	Cu	29	63.546	Radon	Rn	86	(222)
Curium	Cm	96	(247)	Rhenium	Re	75	186.2
Dysprosium	Dy	66	162.50	Rhodium	Rh	45	102.905
Einsteinium	Es	99	(254)	Rubidium	Rb	37	85.47
Erbium	Er	68	167.26	Ruthenium	Ru	44	101.07
Europium	Eu	63	151.96	Samarium	Sm	62	150.35
Fermium	Fm	100	(253)	Scandium	Sc	21	44.956
Fluorine	F	9	18.9884	Selenium	Se	34	78.96
Francium	Fr	87	(223)	Silicon	Si	14	28.086 <sup>3</sup>
Gadolinium	Gd	64	157.25	Silver	Ag	47	107.868
Gallium	Ga	31	69.72	Sodium	Na	11	22.9898
Germanium	Ge	32	72.59	Strontium	Sr	38	87.62
Gold	Au	79	196.967	Sulfur	S	16	32.064 <sup>3</sup>
Hafnium	Hf	72	178.49	Tantalum	Ta	73	180.948
Hahnium	Ha	105	(260)	Technetium	Tc	43	(99)
Helium	He	2	4.0026	Tellurium	Te	52	127.60
Holmium	Ho	67	164.930	Terbium	Tb	65	158.924
Hydrogen	H	1	1.00797 <sup>3</sup>	Thallium	Tl	81	204.37
Indium	In	49	114.82	Thorium	Th	90	232.038
Iodine	I	53	126.9044	Thulium	Tm	69	168.934
Iridium	Ir	77	192.2	Tin	Sn	50	118.69
Iron	Fe	26	55.847	Titanium	Ti	22	47.90
Krypton	Kr	36	83.80	Tungsten	W	74	183.85
Kurchatovium	Ku	104	(260)	Uranium	U	92	238.03
Lanthanum	La	57	138.9	Vandium	V	23	50.942
Lawrencium	Lr	103	(257)	Xenon	Xe	54	131.30
Lead	Pb	82	207.19	Ytterbium	Yb	70	173.04
Lithium	Li	3	6.939	Yttrium	Y	39	88.905
Lutetium	Lu	71	174.97	Zinc	Zn	30	65.37
Magnesium	Mg	12	24.305	Zirconium	Zr	40	91.22
Manganese	Mn	25	54.9380				

These atomic weights are known to be variable because of natural variations in isotopic composition. The observed ranges are B + 0.003, C + 0.00005, H + 0.00001, O + 0.0001, Si + 0.001, S + 0.03.

### PREFIXES USED IN THE METRIC SYSTEM

Prefixes	Meaning	Units
pico- (one trillionth)	$\frac{1}{1,000,000,000,000} = 10^{-12}$	
nano- (one billionth)	$\frac{1}{1,000,000,000} = 10^{-9}$	
micro- (one millionth)	$\frac{1}{1,000,000} = 10^{-6}$	
milli- (one thousandth)	$\frac{1}{1,000} = 10^{-3}$	
centi- (one hundredth)	$\frac{1}{100} = 10^{-2}$	
deci- (one tenth)	$\frac{1}{10} = 10^{-1}$	meter for length
unit (one)	1	
deka- (ten)	10	gram for weight or mass
hecto- (one hundred)	$\frac{100}{1} = 10^2$	
kilo- (one thousand)	$\frac{1,000}{1} = 10^3$	liter for capacity
mega- (one million)	$\frac{1,000,000}{1} = 10^6$	
giga- (one billion)	$\frac{1,000,000,000}{1} = 10^9$	
tera (one trillion)	$\frac{1,000,000,000,000}{1} = 10^{12}$	

**WEIGHT**

The unit of Weight is the gram (g)

The gram is defined as 1/1000 of the mass of the International Prototype Kilogram.

## Abbreviations

U.S. Bu. Stand.	Pharmaceutical			
kg (kilo)	Kg	one kilogram	= 1,000.0	grams
hg	Hg	one hectogram	= 100.0	grams
dkg	Dg	one dekagram	= 10.0	grams
g	Gm		1.0	gram
dg		one decigram	0.1	gram
eg	eg	one centigram	0.001	gram
mg	mg	one milligram	0.001	gram
g (meg or	meg	one microgram	0.000001	gram
		(gamma)		

**VOLUME**

The unit of Volume is the liter (l)

The liter is defined as the volume of a kilogram of water at 4° C and at standard atmospheric pressure. One liter equals 1000.028 cubic centimeters.

## Abbreviations

U.S. Bu. Stand.	Pharmaceutical			
kl	Kl	one kiloliter	= 1,000.0	liters
hl	Hl	one hectoliter	= 100.0	liters
dkl	Dl	one dekaliter	= 10.0	liters
l	L		1.0	liter
dl	dl	one deciliter	0.1	liter
cl	cl	one centiliter	0.001	liter
ml	ml	one milliliter	0.001	liter
	l	one microliter	0.000001	liter

**U.S. SYSTEM OF MEASURES AND WEIGHTS****Length**

- 1 international nautical mile
- 1 statute mile (mi)
- 1 rod (rd)
- 1 yard (yd)
- 1 foot (ft)

**Concentration of Acids and Bases**  
*Common Commercial Strengths*

	Molecular weight	Moles per liter	Grams per liter	Percent by weight	Specific gravity
acetic acid, glacial	60.05	17.4	1045	99.5	1.05
acetic acid	60.05	6.27	376	36	1.045
butyric acid	88.1	10.3	912	95	0.96
formic acid	46.02	23.4	1080	90	1.20
		5.75	264	25	1.06
hydriodic acid	127.9	7.57	969	57	1.70
		5.51	705	47	1.50
		0.86	110	10	1.1
hydrobromic acid	80.92	8.89	720	48	1.50
		6.82	552	40	1.38
hydrochloric acid	36.5	11.6	424	36	1.18
		2.9	105	10	1.05
hydrocyanic acid	27.03	25	676	97	0.697
		0.74	199	2	0.996
hydrofluoric acid	20.01	32.1	642	55	1.167
		28.8	578	50	1.155
hydrofluosilicic acid	144.1	2.65	382	30	1.27
hypophosphorous acid	66.0	9.47	6.25	50	1.25
		5.14	339	30	1.13
		1.57	104	10	1.04
lactic acid	90.1	11.3	1020	85	1.2
nitric acid	63.02	15.99	1008	71	1.42
		14.9	938	67	1.40
		13.3	837	61	1.37
perchloric acid	100.5	11.65	1172	70	1.67
		9.2	923	60	1.54
phosphoric acid	98	14.7	1445	85	1.70
sulfuric acid	98.1	18.0	1766	96	1.84
sulfurous acid	82.1	0.74	61.2	6	1.02
ammonia water	17.0	14.8	252	28	0.898
potassium hydroxide	56.1	13.5	757	50	1.52
		1.94	109	10	1.09
sodium carbonate	106.0	1.04	110	10	1.10
sodium hydroxide	40.0	19.1	763	50	1.53
		2.75	111	10	1.11



**UNIVERSAL INDICATORS**  
**For Approximate pH Determinations**

- No. 1. Dissolve 60 mg methyl yellow, 40 mg methyl red, 80 mg bromthymol blue, 100 mg thymol blue and 20 mg phenolphthalein in 100 ml of ethanol and add enough 0.1N NaOH to produce a yellow color.
- No. 2. Dissolve 18.5 mg methyl red, 60 mg bromthymol blue and 64 mg phenolphthalein in 100 ml of 50% ethanol and add enough 0.1N NaOH to produce a green color.

	Color			Color	
pH			pH		
	No. 1	No. 2		No. 1	No. 2
1	cherry-red	red	7	yellowish-green	greenish-yellow
2	rose	red	8	green	green
3	red-orange	red	9	bluish-green	greenish-blue
4	orange-red	deeper red	10	blue	violet
5	orange	orange-red	11	—	reddish-violet
6	yellow	orange-yellow			

## ***SATURATED SOLUTIONS***

The following table provides the data for making saturated solutions of the substances listed at the temperature designated. Data are provided for making saturated solutions by weight (g of substance per 100 g of saturated solution) and by volume (g of substance per 100 ml of saturated solution and the ml of water required to make such a solution).

To make *one fluid ounce* of a saturated solution: multiply the grams of substance per 100 ml of saturated solution by 4.55 to obtain number of grains required, by 0.01039 to obtain the number of avoirdupois ounces, by 0.00947 to obtain the number of apothecaries (Troy) ounces; also, multiply the ml of water by 16.23 to obtain the number of minims, or divide by 100 to obtain the number of fluid ounces.

To make *one fluid dram*: multiply the grams of substance per 100 ml of saturated solution by 0.5682 to obtain the number of grains required; also, multiply the ml of water by 0.60 to obtain the number of minims required.

Substance	Formula	Temp, °C	g/100g satd soln	g/100ml satd soln	ml water/ 100ml satd soln	Specific gravity
icetanilide	$C_6H_5NHCOCH_3$	25	0.54	0.54	99.2	0.997
?-acetophenetidin	$C_6H_4(OC_2H_5)NHCH_3CO$	25	0.07666	0.0766	99.92	1.00
»-acetotoluide	$CH_3CONHC_6H_4CH_3$	25	0.12	0.12	99.7	0.9979
ilanine	$CH_3CH(NH_2)COOH$	25	14.1	14.7	89.5	1.042
iluminum ammonium sulfate	$Al_2(SO_4)_3(NH_4)_2SO_4 \cdot 24H_2O$	25	12.4	13	92	1.05
iluminum chloride hydrated	$AlCl_3 \cdot 6H_2O$	25	55.5	75	60	1.35
iluminum fluoride	$Al_2F_6 \cdot 5H_2O$	20	0.499	0.5015	100.0	1.0051
iluminum potassium sulfate	$AlK(SO_4)_2$	25	6.62	7.02	99.1	1.061
iluminum sulfate	$Al_2(SO_4)_3 \cdot 18H_2O$	25	48.8	63	66	1.29
7-aminobenzoic acid	$C_6H_4NH_2COOH$	25	0.52	0.519	99.4	0.999
)L-a-amino-n-butyric acid	$CH_3CH_2CH(NH_2)COOH$	25	17.8	18.6	86.2	1.046
DL-a-aminoisobutyric acid	$(CH_3)_2C(NH_2)COOH$	25	13.3	13.7	89.5	1.031
immonium arsenate	$NH_4H_2AsO_4$	20	32.7	40.2	83.0	1.228
immonium benzoate	$NH_4C_7H_5O_2$	25	18.6	19.4	84.7	1.040
immonium bromide	$NH_4Br$	15	41.7	53.8	75.2	1.290
immonium carbonate		25	20	22	88	1.10
immonium chloride	$NH_4Cl$	15	26.3	28.3	79.3	1.075
immonium citrate, dibasic	$(NH_4)_2HC_6H_5O_7$	25	48.7	60.5	61.5	1.22
immonium dichromate	$(NH_4)_2Cr_2O_7$	25	27.9	33	85	1.18
immonium iodide	$NH_4I$	25	64.5	106.2	58.3	1.646
immonium molybdate	$(NH_4)_6Mo_7O_{24} \cdot 4H_2O$	25	30.6	39	88	1.27
immonium nitrate	$NH_4NO_3$	25	68.3	90.2	41.8	1.320
immonium oxalate	$(NH_4)_2C_2O_4 \cdot H_2O$	25	4.95	5.06	97.0	1.019
immonium perchlorate	$NH_4ClO_4$	25	21.1	23.7	88.7	1.123
immonium periodate	$NH_4IO_4$	16	2.63	2.68	99.2	1.018
immonium persulfate	$(NH_4)_2S_2O_8$	25	42.7	53	71	1.24
immonium phosphate, dibasic	$(NH_4)_2HPO_4$	14.5	56.2	75.5	58.8	1.343
immonium phosphate, monobasic	$NH_4H_2PO_4$	25	28.4	33	83	1.16
immonium salicylate	$NH_4C_7H_5O_3$	25	50.8	58.2	56.4	1.145
immonium silicoflouride	$(NH_4)_2SiF_6$	17.5	15.7	17.2	92.3	1.095
immonium sulfate	$(NH_4)_2SO_4$	20	42.6	53.1	71.7	1.248
immonium sulfite	$(NH_4)SO_3 \cdot H_2O$	25	39.3	47.3	73.2	1.204
immonium thiocyanate	$NH_4CNS$	25	62.2	71	43	1.14
imyl alcohol	$C^{\wedge}OH$	25	2.61	2.60	96.9	0.995
maline	$C_6H_5NH_2$	22	3.61	3.61	96.2	0.998
iniline hydrochloride	$C_6H_5NH_2 \cdot HCl$	25	49	54	56	1.10
iniline sulfate	$(C_6H_5NJ_2)_2 \cdot H_2SO_4$	25	5.88	6	96	1.02
^-asparagine	$NH_2COCH_2CH(NH_2)COOH$	25	2.44	2.46	98.2	1.007
)arium bromide	$BaBr_2$	20	51	87.2	83.8	1.710
>arium chlorate	$Ba(ClO_3)_2$	25	28.5	36.8	92.6	1.294
)arium chloride	$BaCl_2$	20	26.3	33.4	93.8	1.27
)arium iodide	$BaI_2 \cdot 7H_2O$	25	68.8	157.0	71.1	2.227
>arium nitrate	$Ba(NO_3)_2$	25	9.4	10.2	97.9	1.080
arium nitrite	$Ba(NO_2)_2$	17	40	59.6	89.4	1.490
)arium perchlorate	$Ba(ClO_4)_2$	25	75.3	145.8	47.8	1.936
>enzamide	$C_6H_5CONH_2$	25	1.33	1.33	98.6	0.999
>enzoic acid	$C_7H_6O_2$	25	0.367	0.367	99.63	1.00
>eryllium sulfate	$BeSO_4 \cdot 4H_2O$	25	28.7	37.3	93.0	1.301
x)ric acid	$H_3BO_3$	25	4.99	5.1	97	1.02
i-butyl alcohol	$CH_3(CH_2)_2CH_2OH$	25	79.7	67.3	17.1	0.845

Substance	Formula	Temp, °C	g/100g satd soln	g/100 ml satd soln	ml water/ 100ml satd soln	Specific gravity
cadmium bromide	CdBr <sub>2</sub> .4H <sub>2</sub> O	25	52.9	94.0	83.9	1.775
cadmium chlorate	Cd(ClO <sub>3</sub> ) <sub>2</sub> .12H <sub>2</sub> O	18	76.4	174.5	54.0	2.284
cadmium chloride	CdCl <sub>2</sub> .2H <sub>2</sub> O	25	54.7	97.2	80.8	1.778
cadmium iodide	CdI <sub>2</sub>	20	45.9	73.0	86.3	1.590
cadmium sulfate	3(CdSO <sub>4</sub> ).8H <sub>2</sub> O	25	43.4	70.3	91.8	1.619
calcium bromide	CaBr <sub>2</sub>	20	58.8	107.2	75.0	1.82
calcium chlorate	Ca(ClO <sub>3</sub> ) <sub>2</sub> .2H <sub>2</sub> O	18	64.0	110.7	62.3	1.729
calcium chloride	CaCl <sub>2</sub> .6H <sub>2</sub> O	25	46.1	67.8	79.2	1.47
calcium chromate	CaCrO <sub>4</sub> .2H <sub>2</sub> O	18	14.3	16.4	98.7	1.149
calcium ferrocyanide	Ca <sub>2</sub> Fe(CN) <sub>6</sub>	25	36.5	49.6	86.2	1.357
calcium iodide	CaI <sub>2</sub>	20	67.6	143.8	69.0	2.125
calcium lactate	Ca(C <sub>3</sub> H <sub>5</sub> O <sub>3</sub> ) <sub>2</sub> .5H <sub>2</sub> O	25	4.95	5	96	1.01
calcium nitrite	Ca(NO <sub>2</sub> ) <sub>2</sub> .4H <sub>2</sub> O	18	45.8	65.7	77.8	1.427
calcium sulfate	CaSO <sub>4</sub> .2H <sub>2</sub> O	25	0.208	0.208	99.70	0.999
camphoric acid	C <sub>8</sub> H <sub>14</sub> (COOH) <sub>2</sub>	25	0.754	0.754	99.246	1.00
carbon disulfide	CS <sub>2</sub>	22	0.173	0.173	99.63	0.998
cerium nitrate	Ce(NO <sub>3</sub> ) <sub>3</sub> .6H <sub>2</sub> O	25	63.7	119.9	68.2	1.880
cesium bromide	CsBr	21.4	53.1	89.8	79.5	1.693
cesium chloride	CsCl	25	65.7	126.3	65.9	1.923
cesium iodide	CsI	22.8	48.0	74.1	80.5	1.545
cesium nitrate	CsNO <sub>3</sub>	25	21.9	26.1	92.9	1.187
cesium perchlorate	CsClO <sub>4</sub>	25	2.01	2.03	99.0	1.010
cesium periodate	CsIO <sub>4</sub>	15	2.10	2.13	99.5	1.017
cesium sulfate	Cs <sub>2</sub> SO <sub>4</sub>	25	64.5	129.8	71.7	2.013
chloral hydrate	CCl <sub>3</sub> CHO.H <sub>2</sub> O	25	79.4	120	31	1.51
chloroform	CHCl <sub>3</sub>	29.4	0.703	0.705	99.57	1.0028
chromic oxide	CrO <sub>3</sub>	18	62.5	106.3	64.0	1.703
chromium potassium sulfate	Cr <sub>2</sub> K <sub>2</sub> (SO <sub>4</sub> ) <sub>4</sub> .24H <sub>2</sub> O	25	19.6	22	90	1.12
citric acid	(CH <sub>2</sub> ) <sub>2</sub> COH(COOH) <sub>3</sub> .H <sub>2</sub> O	25	67.5	88.6	42.7	1.311
cobalt chlorate	Co(ClO <sub>3</sub> ) <sub>2</sub>	18	64.2	119.3	66.5	1.857
cobalt nitrate	Co(NO <sub>3</sub> ) <sub>2</sub>	18	49.7	78.2	79.1	.572
cobalt perchlorate	Co(ClO <sub>4</sub> ) <sub>2</sub>	26	71.8	113.5	44.7	.581
cupric ammonium chloride	CuCl <sub>2</sub> .2NH <sub>4</sub> Cl.2H <sub>2</sub> O	25	30.3	35.5	82	.17
cupric ammonium sulfate	CuSO <sub>4</sub> .(NH <sub>4</sub> ) <sub>2</sub> SO <sub>4</sub>	19	15.3	17.3	96.0	.131
cupric bromide	CuBr <sub>2</sub>	25	55.8	102.5	81.2	.84
cupric chlorate	Cu(ClO <sub>3</sub> ) <sub>2</sub>	18	62.2	105.2	64.1	.692
cupric chloride	CuCl <sub>2</sub> .2H <sub>2</sub> O	25	53.3	80	70	.50
cupric nitrate	Cu(NO <sub>3</sub> ) <sub>2</sub> .6H <sub>2</sub> O	20	56.0	94.5	74.3	.688
cupric selenate	CuSeO <sub>4</sub>	21.2	14.7	17.2	99.4	.165
cupric sulfate	CuSO <sub>4</sub> .5H <sub>2</sub> O	25	18.5	22.3	98.7	1.211
dextrose	C <sub>6</sub> H <sub>12</sub> O <sub>6</sub> .H <sub>2</sub> O	25	49.5	59	60	1.19
ether	(C <sub>2</sub> H <sub>5</sub> ) <sub>2</sub> O	22	5.45	5.34	93.0	0.985
ethyl acetate	CH <sub>3</sub> COOC <sub>2</sub> H <sub>5</sub>	25	7.47	7.44	92.1	0.996
ferric ammonium citrate		25	67.7	97	46	.43
ferric ammonium oxalate	Fe(NH <sub>4</sub> ) <sub>3</sub> (C <sub>2</sub> O <sub>4</sub> ) <sub>3</sub> .3H <sub>2</sub> O	25	51.5	65	61	.26
ferric ammonium sulfate	FeSO <sub>4</sub> .(NH <sub>4</sub> ) <sub>2</sub> SO <sub>4</sub>	16.5	19.1	22.4	94.3	.165
ferric chloride	FeCl <sub>3</sub>	25	73.1	131.1	48.3	.793
ferric nitrate	Fe(NO <sub>3</sub> ) <sub>3</sub>	25	46.8	70.2	79.8	.50
ferric perchlorate	Fe(ClO <sub>4</sub> ) <sub>3</sub> .10H <sub>2</sub> O	25	79.9	132.1	33.2	.656
ferrous sulfate	FeSO <sub>4</sub> .7H <sub>2</sub> O	25	42.1	52.8	12.1	.255

Substance	Formula	Temp, °C	g/100g satd soln	g/100ml satd soln	ml water/ 100ml satd soln	Specific gravity
gallic acid	$C_6H_2(OH)_3COOH.H_2O$	25	1.15	1.15	99.05	1.002
D-glutamic acid	$C_5H_9O_4N$	25	0.86	0.86	99.15	1.0002
glycine	$NH_2CH_2COOH$	25	20.0	21.7	86.8	.083
hydroquinone	$C_6H_4(OH)_2$	20	6.7	6.78	94.4	.012
m-hydroxybenzoic acid	$C_6H_4OHCOOH$	25	0.975	0.975	99.03	.000
lactose	$C_{12}H_{22}O_{11}.H_2O$	25	15.9	17	90	.07
lead acetate	$Pb(C_2H_3O_2)_2$	25	36.5	49.0	85.1	.340
lead bromide	$PbBr_2$	25	0.97	0.98	99.6	.006
lead chlorate	$Pb(ClO_3)_2$	18	60.2	117.0	77.3	.944
lead chloride	$PbCl_2$	25	1.07	1.08	99.6	.007
lead iodide	$PbI_2$	25	0.08	0.08	99.7	0.998
lead nitrate	$Pb(NO_3)_2$	25	37.1	53.6	91.0	1.445
DL-leucine	$C_6H_{13}O_2N$	25	0.976	0.975	98.9	0.999
L-leucine	$C_6H_{13}O_2N$	25	2.24	2.24	97.85	1.0012
lithium benzoate	$LiC_7H_5O_2$	25	27.7	30.4	79.6	1.100
lithium bromate	$LiBrO_3$	18	60.4	110.5	72.5	1.830
lithium carbonate	$Li_2CO_3$	15	1.36	1.38	100.0	1.014
lithium chloride	$LiCl.H_2O$	25	45.9	59.5	70.2	1.296
lithium citrate	$Li_3C_6H_5O_7$	25	31.8	38.6	82.8	1.213
lithium dichromate	$Li_2Cr_2O_7.H_2O$	18	52.6	82.9	74.8	1.574
lithium fluoride	$LiF$	18	0.27	0.27	99.9	1.002
lithium formate	$LiCHO_2$	18	27.9	31.8	80.4	1.140
lithium iodate	$LiIO_3$	18	44.6	69.9	86.8	1.566
lithium nitrate	$LiNO_3$	19	48.9	64.5	67.5	1.318
lithium perchlorate	$LiClO_4.3H_2O$	25	37.5	47.6	79.5	1.269
lithium salicylate	$LiC_7H_5O_3$	25	52.7	63.6	57.1	1.206
lithium sulfate	$Li_2SO_4.H_2O$	25	27.2	33	88.5	1.21
magnesium bromide	$MgBr_2.6H_2O$	18	50.1	83.1	82.8	1.655
magnesium chlorate	$Mg(ClO_3)_2$	18	56.3	90.0	69.7	1.594
magnesium chloride	$MgCl_2.6H_2O$	25	62.5	79	47.5	1.26
magnesium chromate	$MgCr_2O_4.7H_2O$	18	42.0	59.7	82.5	1.422
magnesium dichromate	$MgCr_2O_7.5H_2O$	25	81.0	138.8	32.6	1.712
magnesium iodate	$Mg(IO_3)_2.4H_2O$	18	6.44	6.95	100.8	1.078
magnesium iodide	$MgI_2.8H_2O$	18	59.7	114.0	77.1	1.909
magnesium molybdate	$MgMoO_4$	25	15.9	18.4	97.4	1.159
magnesium nitrate	$Mg(NO_3)_2.6H_2O$	25	42.1	56.6	80.5	1.388
magnesium perchlorate	$Mg(ClO_4)_2.6H_2O$	25	49.9	73.6	73.9	1.472
magnesium selenate	$MgSeO_4$	20	35.3	50.8	93.0	1.440
magnesium sulfate	$MgSO_4.7H_2O$	25	55.3	72	58.5	1.30
manganese chloride	$MnCl_2$	25	43.6	63.2	82.0	1.449
manganese nitrate	$Mn(NO_3)_2.6H_2O$	18	57.3	93.2	69.2	1.624
manganese silicofluoride	$MnSiF_6$	17.5	37.7	54.5	90.1	1.446
manganese sulfate	$MnSO_4$	25	39.4	59.1	90.8	1.499
mercuric acetate	$Hg(C_2H_3O_2)_2$	25	30.2	38	88	1.26
mercuric bromide	$HgBr_2$	25	0.609	0.610	99.6	1.0023
mercury bichloride	$HgCl_2$	25	6.6	6.96	98.5	1.054
methylene blue	$C_{16}H_{18}N_3ClS.3H_2O$	25	4.25	4.3	97	1.01
methyl salicylate	$C_6H_4OHCOOCH_3$	25	0.12	0.12	99.88	1.00
monochloroacetic acid	$CH_2ClCOOH$	25	78.8	105	28	1.33
B-naphthalenesulfonic acid	$C_{10}H_7SO_3H$	30	56.9	67.9	51.4	1.193
nickel ammonium sulfate	$NiSO_4(NH_4)_2SO_4.6H_2O$	25	9.0	9.5	96	1.05

Substance	Formula	Temp, °C	g/100g satd soln	g/100 ml satd soln	ml water/ 100ml satd soln	Specific gravity
nickel chlorate	Ni(ClO <sub>3</sub> ) <sub>2</sub>	18	56.7	94.2	72.0	1.658
nickel chlorate	Ni(ClO <sub>3</sub> ) <sub>2</sub> .6H <sub>2</sub> O	18	64.5	107.2	59.1	1.661
nickel nitrate	Ni(NO <sub>3</sub> ) <sub>2</sub> .6H <sub>2</sub> O	25	77	122	36	1.58
nickel perchlorate	Ni(ClO <sub>4</sub> ) <sub>2</sub>	26	70.8	112.2	46.4	1.584
nickel perchlorate	Ni(ClO <sub>4</sub> ) <sub>2</sub> .9H <sub>2</sub> O	18	52.4	82.7	75.1	1.576
nickel sulfate	NiSO <sub>4</sub> .6H <sub>2</sub> O	25	47.3	64	71	1.35
DL-norleucine	C <sub>6</sub> H <sub>13</sub> N <sub>2</sub> O <sub>2</sub>	25	1.13	1.13	98.97	0.999
oxalic acid	H <sub>2</sub> C <sub>2</sub> O <sub>4</sub> .2H <sub>2</sub> O	25	9.81	10.3	94.2	1.044
phenol	C <sub>6</sub> H <sub>5</sub> OH	20	6.1	6.14	94.5	1.0057
.B-phenylalanine	C <sub>6</sub> H <sub>5</sub> CH <sub>2</sub> CH(NH <sub>2</sub> )COOH	25	2.88	2.89	97.5	1.0035
m-phenylenediamine	C <sub>6</sub> H <sub>8</sub> N <sub>2</sub>	20	23.1	23.8	79.3	1.032
/>-phenylenediamine	C <sub>6</sub> H <sub>8</sub> N <sub>2</sub>	20	3.69	3.70	96.67	1.0038
phenyl salicylate	C <sub>6</sub> H <sub>4</sub> OHCOOC <sub>6</sub> H <sub>5</sub>	25	0.015	0.015	99.84	0.999
phenyl thiourea	CS(NH <sub>2</sub> )NHC<,H <sub>5</sub>	25	0.24	0.24	99.6	0.998
phosphomolybdic acid	20MoO <sub>3</sub> .2H <sub>3</sub> PO <sub>4</sub> .48H <sub>2</sub> O	25	74.3	135	46	1.81
phosphotungstic acid	Approx. 20WO <sub>3</sub> .2H <sub>3</sub> PO <sub>4</sub> .25H <sub>2</sub> O	25	71.4	160	64	2.24
potassium acetate	KC <sub>2</sub> H <sub>3</sub> O <sub>2</sub>	25	68.7	97.1	44.3	1.413
potassium antimony tartrate	KSbOC <sub>4</sub> H <sub>4</sub> O <sub>6</sub>	25	7.64	8.02	96.9	1.049
potassium bicarbonate	KHCO <sub>3</sub>	25	26.6	31.6	87.5	1.188
potassium bitartrate	KC <sub>4</sub> H <sub>5</sub> O <sub>6</sub>	25	0.65	0.65	99.3	0.999
potassium bromate	KBrO <sub>3</sub>	25	7.53	7.89	97.5	1.054
potassium bromide	KBr	25	40.6	56.0	82.0	1.380
potassium carbonate	K <sub>2</sub> CO <sub>3</sub> .mH <sub>2</sub> O	25	52.9	82.2	73.5	1.559
potassium chlorate	KClO <sub>3</sub>	25	8.0	8.41	96.6	1.051
potassium chloride	KCl	25	26.5	31.2	86.8	1.178
potassium chromate	K <sub>2</sub> CrO <sub>4</sub>	25	39.4	54.1	83.7	1.381
potassium citrate	K <sub>3</sub> C <sub>6</sub> H <sub>5</sub> O <sub>7</sub>	25	60.91	92.1	59.2	1.514
potassium dichromate	K <sub>2</sub> Cr <sub>2</sub> O <sub>7</sub>	25	13.0	14.2	95.0	1.092
potassium ferricyanide	K <sub>3</sub> Fe(CN) <sub>6</sub>	22	32.1	38.1	80.8	1.187
potassium ferrocyanide	K <sub>4</sub> Fe(CN) <sub>6</sub>	25	24.0	28.2	89.2	1.173
potassium fluoride	KF.2H <sub>2</sub> O	18	48.0	72.0	78.0	1.500
potassium formate	KCHO <sub>2</sub>	18	76.8	120.6	36.4	1.571
potassium hydroxide	KOH	15	51.7	79.2	74.2	1.536
potassium iodate	KIO <sub>3</sub>	25	8.40	8.99	98.0	1.071
potassium iodide	KI	25	59.8	103.2	69.1	1.721
potassium meta-antimonate	KSbO <sub>3</sub>	18	2.73	2.81	99.7	1.025
potassium nitrate	KNO <sub>3</sub>	25	28.0	33.4	86.0	1.193
potassium nitrite	KNO <sub>2</sub>	20	74.3	121.5	42.3	1.649
potassium oxalate	K <sub>2</sub> C <sub>2</sub> O <sub>4</sub> .H <sub>2</sub> O	25	28.3	34	86	1.20
potassium perchlorate	KClO <sub>4</sub>	25	2.68	2.72	99.0	1.014
potassium periodate	KIO <sub>4</sub>	13	0.658	0.661	99.83	1.005
potassium permanganate	KMnO <sub>4</sub>	25	7.10	7.43	97.3	1.046
potassium sodium tartrate	KNaC <sub>4</sub> H <sub>4</sub> O <sub>6</sub> .4H <sub>2</sub> O	25	39.71	51.9	78.8	1.308
potassium stannate	K <sub>2</sub> SnO <sub>3</sub>	15.5	42.7	69.2	92.9	1.620
potassium sulfate	K <sub>2</sub> SO <sub>4</sub>	25	10.83	11.8	96.9	1.086
quinine salicylate	C <sub>20</sub> H <sub>24</sub> N <sub>2</sub> O <sub>2</sub> .C <sub>6</sub> H <sub>4</sub> (OH)- COOH.2H <sub>2</sub> O	25	0.065	0.065	99.84	0.999
resorcinol	C <sub>6</sub> H <sub>4</sub> (OH) <sub>2</sub>	25	58.8	67.2	47.2	1.142
rubidium bromate	RbBrO <sub>3</sub>	16	2.15	2.18	99.4	1.016
rubidium bromide	RbBr	25	52.7	85.6	76.9	1.625

Substance	Formula	Temp, °C	g/100g satd soln	g/100 ml satd soln	ml water/ 100ml satd soln	Specific gravity
rubidium chloride	RbCl	25	48.6	72.8	77.1	1.50
rubidium iodate	RbIO <sub>3</sub>	15.6	2.72	2.78	99.5	1.022
rubidium iodide	RbI	24.3	63.6	117.7	67.3	1.850
rubidium nitrate	RbNO <sub>3</sub>	25	40.1	55.0	82.4	1.375
rubidium perchlorate	RbClO <sub>4</sub>	25	1.88	1.90	99.3	1.012
rubidium periodate	RbIO <sub>4</sub>	16	0.645	0.648	99.85	1.0052
rubidium sulfate	Rb <sub>2</sub> SO <sub>4</sub>	25	33.8	45.6	89.7	1.354
silicotungstic acid	HiSiW.A.	18	90.6	258	26.8	2.843
silver acetate	Ag(C <sub>2</sub> H <sub>3</sub> O <sub>2</sub> )	25	1.10	1.11	99.40	1.0047
silver bromate	AgBrO <sub>3</sub>	25	0.204	0.2037	99.65	0.9985
silver fluoride	AgF.2H <sub>2</sub> O	15.8	64.5	168.4	92.7	2.61
silver nitrate	AgNO <sub>3</sub>	25	71.5	164	65.5	2.29
silver perchlorate	AgClO <sub>4</sub> .H <sub>2</sub> O	25	84.5	237.1	43.5	2.806
sodium acetate	NaC <sub>2</sub> H <sub>3</sub> O <sub>2</sub>	25	33.6	40.5	80.0	1.205
sodium ammonium sulfate	NaNH <sub>4</sub> SO <sub>4</sub>	15	25.2	29.6	87.9	1.174
sodium arsenate	Na <sub>3</sub> AsO <sub>4</sub> .12H <sub>2</sub> O	17	21.1	23.5	88.0	1.119
sodium benzenesulfonate	NaC <sub>6</sub> H <sub>5</sub> SO <sub>3</sub>	25	16.4	17.6	90.1	1.076
sodium benzoate	NaC <sub>7</sub> H <sub>5</sub> O <sub>2</sub>	25	36.0	41.5	73.9	1.152
sodium bicarbonate	NaHCO <sub>3</sub>	15	8.28	8.80	97.6	1.061
sodium bisulfate	NaHSO <sub>4</sub> .H <sub>2</sub> O	25	59	87	60	1.47
sodium bromide	NaBr.2H <sub>2</sub> O	25	48.6	75.0	79.4	1.542
sodium carbonate	Na <sub>2</sub> CO <sub>3</sub> .10H <sub>2</sub> O	25	22.6	28.1	96.5	1.242
sodium chlorate	NaClO <sub>3</sub>	25	51.7	74.3	69.6	1.440
sodium chloride	NaCl	25	26.5	31.7	88.1	1.198
sodium chromate	Na <sub>2</sub> CrO <sub>4</sub>	18	40.2	57.4	85.7	1.430
sodium citrate	Na <sub>3</sub> C <sub>6</sub> H <sub>5</sub> O <sub>7</sub> .5H <sub>2</sub> O	25	48.1	61.2	66.0	1.272
sodium dichromate	Na <sub>2</sub> Cr <sub>2</sub> O <sub>7</sub>	18	63.9	111.4	63.0	1.743
sodium ferrocyanide	Na <sub>4</sub> Fe(CN) <sub>6</sub>	25	17.1	19.4	93.9	1.131
sodium fluoride	NaF	25	3.98	4.14	99.7	1.038
sodium formate	NaCHO <sub>2</sub>	18	44.7	58.9	73.0	1.316
sodium hydroxide	NaOH	25	50.8	77	74	1.51
sodium hypophosphite	NaH <sub>2</sub> PO <sub>2</sub>	16	52.1	72.4	66.6	1.386
sodium iodate	NaIO <sub>3</sub> .H <sub>2</sub> O	25	8.57	9.21	98.5	1.075
sodium iodide	NaI	25	64.8	124.3	67.7	1.919
sodium molybdate	Na <sub>2</sub> MoO <sub>4</sub>	18	39.4	56.6	87.0	1.435
sodium nitrate	NaNO <sub>3</sub>	25	47.9	66.7	72.5	1.391
sodium nitrite	NaNO <sub>2</sub>	20	45.8	62.3	73.8	1.359
sodium oxalate	Na <sub>2</sub> (C <sub>2</sub> O <sub>2</sub> ) <sub>2</sub>	25	3.48	3.58	99.1	1.025
sodium paratungstate	(Na <sub>2</sub> O) <sub>3</sub> (WO <sub>3</sub> ) <sub>7</sub> .16H <sub>2</sub> O	0	26.7	35.2	96.5	1.316
sodium perchlorate	NaClO <sub>4</sub>	25	67.8	114.1	54.1	1.683
sodium periodate	NaIO <sub>4</sub> .3H <sub>2</sub> O	25	12.6	13.9	96.2	1.103
sodium phenolsulfonate	C <sub>6</sub> H <sub>4</sub> (OH)SO <sub>3</sub> Na	25	16.1	17.4	90.5	1.079
sodium phosphate dibasic	Na <sub>2</sub> HPO <sub>4</sub>	17	4.2	4.4	99.9	1.043
sodium phosphate tribasic	Na <sub>3</sub> PO <sub>4</sub>	14	9.5	10.5	99.8	1.103
sodium pyrophosphate	Na <sub>2</sub> H <sub>2</sub> P <sub>2</sub> O <sub>7</sub> .6H <sub>2</sub> O	25	13.0	14.4	95.8	1.104
sodium salicylate	NaC <sub>7</sub> H <sub>5</sub> O <sub>3</sub>	25	53.6	67.0	58.0	1.248
sodium selenate	Na <sub>2</sub> SeO <sub>4</sub>	18	29.0	38.1	93.4	1.313
sodium silicofluoride	NaSiF <sub>6</sub>	20	0.773	0.737	99.76	1.0054
sodium sulfate	Na <sub>2</sub> SO <sub>4</sub>	25	21.8	26.4	94.5	1.208
sodium sulfate	Na <sub>2</sub> SO <sub>4</sub> .10H <sub>2</sub> O	25	27.7	33.3	87.0	1.207

Substance	Formula	Temp, °C	g/100g satd soln	g/100 ml satd soln	ml water/ 100ml satd soln	Specific gravity
sodium sulfide	$\text{Na}_2\text{S}\cdot 9\text{H}_2\text{O}$	25	52.3	63	57	1.20
sodium sulfite, anhydrous	$\text{Na}_2\text{SO}_3$	25	23	28.5	95.5	.24
sodium thiocyanate	$\text{NaCNS}$	25	62.9	87	51	.38
sodium thiosulfate	$\text{Na}_2\text{S}_2\text{O}_3\cdot 5\text{H}_2\text{O}$	25	66.8	93	46	.39
sodium tungstate	$\text{Na}_2\text{WO}_4\cdot 10\text{H}_2\text{O}$	18	42.0	66.1	91.3	.573
stannous chloride	$\text{SnCl}_2$	15	72.9	133.1	49.5	.827
strontium chlorate	$\text{Sr}(\text{ClO}_3)_2$	18	63.6	117.0	67.0	.839
strontium chloride	$\text{SrCl}_2\cdot 6\text{H}_2\text{O}$	15	33.4	45.5	90.7	.36
strontium iodide	$\text{SrI}_2\cdot 6\text{H}_2\text{O}$	20	64.0	137.8	77.5	2.15
strontium nitrate	$\text{Sr}(\text{NO}_3)_2$	25	44.2	65.3	82.5	1.477
strontium nitrite	$\text{Sr}(\text{NO}_2)_2$	19	39.3	56.8	87.8	1.445
strontium perchlorate	$\text{Sr}(\text{ClO}_4)_2$	25	75.6	158.5	50.8	2.084
strontium salicylate	$\text{Sr}(\text{C}_7\text{H}_5\text{O}_3)_2$	25	4.58	4.68	97.5	1.019
succinic acid	$(\text{CH}_2)_2(\text{COOH})_2$	25	7.67	7.82	94.5	1.021
succinimide	$(\text{CH}_2\text{CO})_2\text{NH}\cdot \text{H}_2\text{O}$	25	30.6	32.7	74.2	1.067
sucrose	$\text{C}_{12}\text{H}_{22}\text{O}_{11}$	25	67.89	90.9	43.0	1.340
tartaric acid	$\text{C}_2\text{H}_2(\text{OH})_2(\text{COOH})_2$	15	58.5	76.9	54.7	1.31
tetraethyl ammonium iodide	$\text{N}(\text{C}_2\text{H}_5)_4\text{I}$	25	32.9	36.2	74.0	1.102
tetramethyl ammonium iodide	$\text{N}(\text{CH}_3)_4\text{I}$	25	5.51	5.60	96.1	1.016
thallium chloride	$\text{TlCl}$	25	0.40	0.40	99.6	1.0005
thallium nitrate	$\text{TlNO}_3$	25	10.4	11.4	98.0	1.093
thallium nitrite	$\text{TlNO}_2$	25	32.1	43.7	92.5	1.360
thallium perchlorate	$\text{TlClO}_4$	25	13.5	15.2	97.1	1.122
thallium sulfate	$\text{Tl}_2\text{SO}_4$	25	5.48	5.74	99.0	1.047
trichloroacetic acid	$\text{CCl}_3\text{COOH}$	25	92.3	149.6	12.41	1.615
uranyl chloride	$\text{UO}_2\text{Cl}_2$	18	76.2	208.5	65.2	2.736
uranyl nitrate	$\text{UO}_2(\text{NO}_3)_2\cdot 6\text{H}_2\text{O}$	25	68.9	120	54.5	1.74
urea	$(\text{NH}_2)_2\text{CO}$	25	53.8	62	53.5	1.15
urea phosphate	$\text{CO}(\text{NH}_2)_2\cdot \text{H}_3\text{PO}_4$	24.5	52.4	66.1	60.1	1.26
urethan	$\text{NH}_2\text{CO}_2\text{C}_2\text{H}_5$	25	82.8	88.8	18.5	1.073
D-valine	$(\text{CH}_3)_2\text{CHCH}(\text{NH}_2)\text{COOH}$	25	8.14	8.26	93.3	1.015
DL-valine	$(\text{CH}_3)_2\text{CHCH}(\text{NH}_2)\text{COOH}$	25	6.61	6.68	94.5	1.012
zinc acetate	$\text{Zn}(\text{C}_2\text{H}_3\text{O}_2)_2$	25	25.7	30.0	86.5	.165
zinc benzenesulfonate	$\text{Zn}(\text{C}_6\text{H}_5\text{SO}_3)_2$	25	29.5	34.9	83.4	.182
zinc chlorate	$\text{Zn}(\text{ClO}_3)_2$	18	65.0	124.4	67.0	.914
zinc chloride	$\text{ZnCl}_2$	25	67.5	128	61	.89
zinc iodide	$\text{ZnI}_2$	18	81.2	221.3	51.2	2.725
zinc phenolsulfonate	$(\text{C}_6\text{H}_5\text{OSO}_3)_2\text{Zn}\cdot 8\text{H}_2\text{O}$	25	39.8	47.3	71.5	.185
zinc selenate	$\text{ZnSeO}_4$	22	37.8	58.9	97.0	.559
zinc silicofluoride	$\text{ZnSiF}_6\cdot 6\text{H}_2\text{O}$	20	32.9	47.2	96.3	.434
zinc sulfate	$\text{ZnSO}_4\cdot 7\text{H}_2\text{O}$	25	36.7	54.6	94.7	.492
zinc valerate	$\text{Zn}(\text{C}_5\text{H}_9\text{O}_2)_2$	25	1.27	1.27	98.8	.001



Substance	of substance	of water	minutes in C	temp. F
ammonium nitrate	100	94	— 4.0	25
sodium acetate	85	100	— 4.7	23
sodium nitrate	75	100	— 5.3	22.5
sodium thiosulfate cryst	110	100	— 8.0	18
calcium chloride, 6H <sub>2</sub> O	100	246 (ice)	— 9.0	16
sodium chloride	36	100	— 10.0	14
ammonium nitrate	45	100 (ice)	— 16.8	15
sodium nitrate	50	100 (ice)	— 17.8	0
ammonium thiocyanate	133	100	— 18.0	0
sodium chloride	33	100 (ice)	—21.3	— 6
calcium chloride, 6H <sub>2</sub> O	100	123 (ice)	—21.5	— 6.5
sodium bromide	66	100 (ice)	— 28	— 18
magnesium chloride cryst	85	100 (ice)	— 34	— 29
sulfuric acid (66.1% H <sub>2</sub> SO <sub>4</sub> )	100	109.7 (snow)	—37.0	— 34.6
calcium chloride, 6H <sub>2</sub> O	100	81 (ice)	—40.3	— 40
calcium chloride, 6H <sub>2</sub> O	100	70 (ice)	— 55	— 67
alcohol at 4° C with solid carbon dioxide			— 72	— 98
chloroform with solid carbon dioxide			— 77	— 106
acetone with solid carbon dioxide			— 86	— 123
ether with solid carbon dioxide			— 100	— 148
solid carbon dioxide (dry ice) sublimates at			—78.5	— 109

### *CONSTANT HUMIDITY SOLUTIONS*

A saturated aqueous solution in contact with an excess of the solute when kept in an enclosed space will maintain a constant humidity at a given temperature.

Substance dissolved and solid phase	Temp. °C	% Humidity
lead nitrate, $\text{Pb}(\text{NO}_3)_2$	20	98
dibasic sodium phosphate, $\text{Na}_2\text{HPO}_4 \cdot 12\text{H}_2\text{O}$	20	95
monobasic ammonium phosphate, $\text{NH}_4\text{H}_2\text{PO}_4$	20-25	93
zinc sulfate, $\text{ZnSO}_4 \cdot 7\text{H}_2\text{O}$	20	90
potassium chromate, $\text{K}_2\text{CrO}_4$	20	88
potassium bisulfate, $\text{KHSO}_4$	20	86
potassium bromide, $\text{KBr}$	20	84
ammonium sulfate, $(\text{NH}_4)_2\text{SO}_4$	20	81
ammonium chloride, $\text{NH}_4\text{Cl}$	20-25	79
sodium acetate, $\text{NaC}_2\text{H}_3\text{O}_2 \cdot 3\text{H}_2\text{O}$	20	76
sodium chlorate, $\text{NaClO}_3$	20	75
sodium nitrite, $\text{NaNO}_2$	20	66
sodium bromide, $\text{NaBr} \cdot 2\text{H}_2\text{O}$	20	58
magnesium nitrate, $\text{Mg}(\text{NO}_3)_2 \cdot 6\text{H}_2\text{O}$	18.5	56
sodium dichromate, $\text{Na}_2\text{Cr}_2\text{O}_7 \cdot 2\text{H}_2\text{O}$	20	52
potassium thiocyanate, $\text{KSCN}$	20	47
zinc nitrate, $\text{Zn}(\text{NO}_3)_2 \cdot 6\text{H}_2\text{O}$	20	42
chromium trioxide, $\text{CrO}_3$	20	35
calcium chloride, $\text{CaCl}_2 \cdot 6\text{H}_2\text{O}$	24.5	31
potassium acetate, $\text{KC}_2\text{H}_3\text{O}_2$	20	20
lithium chloride, $\text{LiCl} \cdot \text{H}_2\text{O}$	20	15